

MICHELIN AIRCRAFT TIRE

**Aircraft tire**  
**Care & Service Manual**



**Note : This document, Michelin  
Reference**

**#MAT-CSM-01 Rev. A**

**supercedes Reference  
#MAT-CSM-95 Rev. B,  
#MAT-CSM-95 Rev. A,  
Michelin document MAINT-  
0013 and the document  
entitled Michelin Aircraft Tire  
Care & Maintenance.**

# Table of contents

<b>Introduction</b>	<b>6</b>	<b>Branding</b>	<b>12</b>	<b>is Not Recommended</b>	<b>22</b>
<b>Aircraft Tire Construction</b>	<b>7</b>	<b>Tire serial number codes</b>	<b>17</b>	Store Tubes Properly	23
The Tread	8	<b>General Safety Considerations</b>	<b>18</b>	Tire and Tube Age Limit	23
The Undertread	8	Mounting	19	Storage of Inflated Tire and Wheel Assemblies	23
A Carcass Ply	8	Inflating	19	<b>Ozone</b>	<b>24</b>
- For Bias		Tires In Service	19	Recommendations for Storage and Handling	25
- For Radial		- Transportation		<b>General Mounting Instructions For Aircraft Tires</b>	<b>26</b>
The Beads	9	<b>Storing Aircraft Tires And Tubes</b>	<b>20</b>	General	27
Chafer Strips	9	Handling Aircraft Tires	21	Premounting Checklist	27
The Liner	9	Avoid Moisture and ozone	21	- Wheels	
The Sidewall	9	- Ozone - What is it ?		- Tires	
Products Unique to the Bias Tire	10	- Impact of ozone on tires		<b>Mounting</b>	<b>29</b>
- The Tread Reinforcing Ply		Designing for ozone	21	- Use of Inner Tubes	
- Breaker Plies		Store away from fuel and solvents	22	Bias Tires	
- ORION™ technology		Store in the Dark	22	Radial Tires	
- Fabric Tread		Store Tires Vertically	22	- Lubrication of Tire Beads	
- Spiral Wrap		Horizontal Stacking of Tires		Bias Tires	
Products Unique to the Radial Tire	11			Radial Tires	
- The Protector Ply				- Tire/Wheel Assembly	
- Belt Plies				- Tire/Wheel Alignment	
Chine Tires	11				

# Table of contents

- Inflating With Nitrogen				
- Special Procedure Properly Seat Tube-Type Tires				
<b>Basic Pressure Retention Check</b>	<b>31</b>	<b>the Most Out of Your Tires</b>	<b>39</b>	- Normal Response
- Procedure		- Effects of Underinflation		- Testing For Pressure Loss
<b>Emergency Pressure Retention Check</b>	<b>32</b>	- Effects of Overinflation		- Causes of Pressure Loss
- Procedure		<b>Checking Duals for Equal Operating Pressure</b>	<b>40</b>	<i>Tire Growth</i>
<b>Alternate Pressure Retention Check</b>	<b>32</b>	<b>Proper Inflation - Setting the Pressure Level</b>	<b>41</b>	<i>Drop in Ambient Temperature</i>
- Procedure		- Inflating and Reinflating the Tire/Wheel Assembly		<i>Approved Calibrated Gauge</i>
<b>Sidewall Venting</b>	<b>33</b>	- Loaded versus Unloaded Tires		<i>Foreign Object Damage</i>
<b>Not all aircraft tires are vented</b>	<b>33</b>	- Properly Inflating Tube - Type Tires		<i>Improperly Seated Beads</i>
<b>Storage of an Inflated Tire and Wheel Assembly</b>	<b>34</b>	<b>Effect of ambient temperature on gauge pressure</b>	<b>42</b>	<i>Valve Stem or Valve Core</i>
<b>Mounting Tire/Wheel Assembly On The Aircraft</b>	<b>36</b>	- Effect of temperature		<i>Valve Seal</i>
Visually Inspect Tire/Wheel Assembly	37	- Proper Inflation - Standard for Maintaining Pressure Level		<i>Wheel Half Parting Line O-Ring Seal</i>
Readjust Tire Pressure	37	- Aircraft experiencing large ambient temperature differences between airports		<i>Fuse Plug</i>
<b>Inflation Pressure Maintenance</b>	<b>38</b>	<b>Schedule and action</b>	<b>44</b>	<i>Pressure Release Plug</i>
Proper Inflation - Getting		- When to Check		<i>Seepage Between Tire Bead and Wheel Flange</i>
		Frequency		<i>Leakage Through the Well Area</i>
		Checking Hot Tires		<i>Damaged Wheel Sealing Surfaces</i>
		Compare tire pressures on the same given landing gear		<i>Damage to the Tire Innerliner</i>
		Single and Multiple tire gear		<i>Cracks or Splits in the Inner Tube</i>
		Two Tire Gear		- Troubleshooting - Have You Considered?
		Three or more tire gear		
		- Monitoring Inflation Pressure - What To Do		
		<b>Pressure Loss</b>	<b>46</b>	
				<b>Tire Serviceability Criteria</b>
				<b>51</b>
				<b>On Aircraft Inspection With Tire Mounted</b>
				<b>52</b>
				Removal Criteria - Wear
				<b>Water can affect traction</b>
				<b>52</b>
				- Typical Wear Conditions
				Normal Wear
				Overinflation
				Underinflation



*Worn Beyond Recommended Limits*  
*Flat Spotting*  
*Asymmetrical Wear*  
*Serviceability Criteria/ Limits*  
*For Tire Damages*  
*Tread Wear*  
*Tread Cuts/ Foreign Objects*  
*Sidewall Cuts / Foreign Objects*

**Serviceability Criteria/  
Operational Conditions 63**

- *Hard Landing*
- *Rejected Takeoff*

**Off-Aircraft Inspection  
With Tire Dismounted 64**

- *A Systematic Approach to Tire Inspection*
- Bias tires*
- Radial tires*

**Matching  
and Mixability  
of Dual Tires 66**

**Matching Tires 67**

- *Matching Criteria*
- Bias Tires*
- Radial Tires*
- New versus Retreaded Tires*
- *Mixability*
- Bias - Bias*
- Radial - Radial*
- Bias - Radial*

- *Observe Load and Inflation Recommendations*

**Vibration  
and Balance 70**

- Proper inflation pressure*
- Inflation is equalized*
- Full growth*
- Beads properly seated*
- Flat spotting/uneven wear*
- Properly mounted*
- Air trapped between tire and tube*
- Tube wrinkled*
- Wheel out of balance*
- Condition of wheel*
- Loose wheel bearing*
- Gear alignment*
- Worn gear components*

**General Dismounting  
Instructions  
For Aircraft Tires 72**

**Removal From Landing Gear 73**

**Reason for removal-  
Tracking 73**

**Tire Dismounting 73**

- *Tire/ Wheel Dismounting Sequence*

**Tire Dismounting Equipment 75**

**Retreading  
and Repairing  
Aircraft Tires 77**

**Retreading Aircraft Tires 78**

**Accepting Tires  
For Retreading 78**

**Repairing Aircraft Tires 78**

**Non-Repairable Aircraft Tires 79**

**Repairable Aircraft Tires 79**

**Operating and  
Handling Tips for  
Better Tire Service 80**

**Taxiing 81**

**Pivoting By Using Brakes 81**

**Condition of Airport Field 82**

**Avoid Chemical  
Contamination 82**

**Nylon Flat Spotting 82**

**Chevron Cutting 83**

**Hydroplaning 83**

**Landings Per Tread 84**

# Introduction



**For aircraft tires** to deliver maximum performance, reliability, durability and safety, they must be properly cared for and serviced.

**This manual** is designed as a guide to the procedures to be used for all aspects of aircraft tire care and operation. It provides detailed information about how to operate aircraft tires to achieve optimum service. It also covers installation, removal and servicing techniques. It should be used in conjunction with the operating procedures given by the aircraft and wheel manufacturers.

**The procedures** given in this manual apply to all Michelin manufactured aircraft tires, new or retreaded, regardless of the family name, current (Michelin Air, Michelin Air X, Michelin Aviator, Aviator, BF Goodrich, AAT, Silvertown) or future. The same service and care techniques should be used for both **Bias** and **Radial** tires. In some specific cases, due to the nature of bias and radial tire constructions, differences in service techniques may exist. Where applicable, these differences have been noted.

Whether you operate a single aircraft, or a fleet, the principles and procedures contained in this manual will be of benefit.

If further information is needed, please contact your Michelin Representative.

See back cover for regional contacts.

# *Tire construction*

## **Aircraft tire construction**

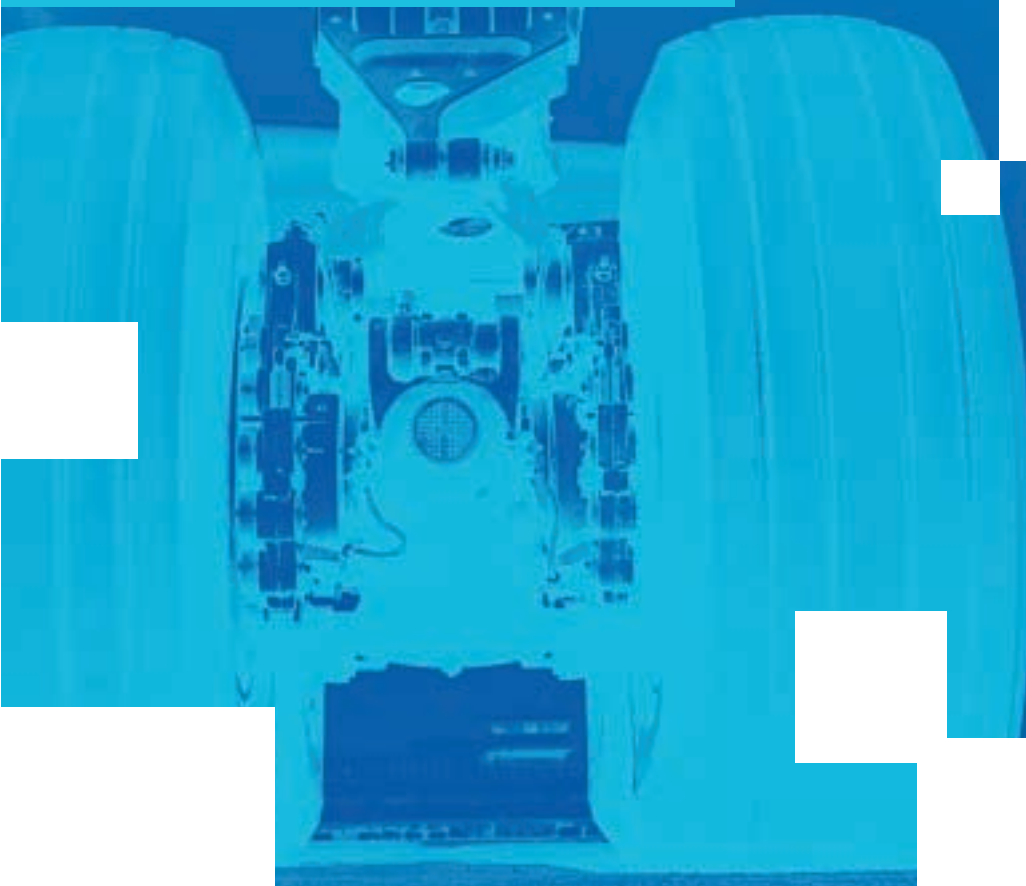

# Aircraft tire construction

8

*An aircraft tire must withstand a wide range of operational conditions. When on the ground, it must support the weight of the aircraft. During taxi, it must provide a stable, cushioned ride while resisting heat generation, abrasion and wear. At take-off, the tire structure must be able to endure not only the aircraft load but also the forces generated at high angular velocities. Landing requires the tire to absorb impact shocks while also transmitting high dynamic braking loads to the ground. All of this must be accomplished while providing a long, dependable, reliable, service life.*

*These extreme demands require a tire which is highly engineered and precisely manufactured. For this reason, tires are designed as a composite of various rubber, fabric and steel products. Each of the components serves a very specific function in the performance of the tire.*

*To meet the aircraft demands of today and tomorrow, Michelin designs and produces two different and distinct tire constructions, the conventional*

*cross-ply or BIAS tire and the RADIAL tire. Both nomenclatures describe the angular direction of the carcass plies.*

*While many of the components of bias and radial tires have the same terminology, the carcass ply angles are not the only difference between a bias constructed tire and a radial constructed tire. The technologies utilized are quite different involving different design parameters, compounds, and materials.*

**The tread** refers to the crown area of the tire in contact with the ground. Most Michelin tires are designed with circumferential grooves molded into the tread area. These provide a mechanism to channel water from between the tire and runway surface which helps to improve ground adhesion.

The tread compound is formulated to resist wear, abrasion, cutting, cracking and heat buildup. It prolongs the life of the casing by protecting the underlying carcass plies.

**The undertread** is a layer of specially formulated rubber designed to enhance the bonding between the tread reinforcement/protector plies and the carcass body. For those tires designed to be retreaded, this rubber layer will be of sufficient thickness to act as the interface for buffing the old tread assembly, as well as the liaison with the new retread products.

**A carcass ply** consists of fabric cords sandwiched between two layers of rubber. Today, the most common fabric cord is nylon. The carcass body itself is made from multiple layers of carcass plies, each one adding to the strength and load bearing capability of the tire. The carcass plies are anchored by wrapping them around bead wires, thus forming the **PLY TURN-UPS**.

**FOR BIAS** constructed tires, the carcass plies are laid at angles between 30° and 60° to the centerline or direction of rotation of the tire. Succeeding plies are laid with cord





angles opposite to each other, to provide balanced carcass strength.

**FOR RADIAL** constructed tires, each carcass ply is laid at an angle approximately 90° to the centerline or direction of rotation of the tire. Each successive layer is laid at a similar angle. Radial constructed tires of the same size have a fewer number of plies than do tires of a bias construction, because the radial cord direction is aligned with the burst pressure radial force allowing for optimized construction.

**The beads** or bead wires anchor the tire to the wheel. They are fabricated from steel wires layered together and can be embedded with rubber to form a bundle. The bundle is then wrapped with rubber coated fabric for reinforcement.

Depending on the size and design application, BIAS tires are constructed with 2 to 6 bead bundles (1 to 3 per side). By contrast, RADIAL constructed tires have 2 bead bundles (1 on each side) regardless of tire size.

**Chafer strips** are strips of protective fabric or rubber laid over the outer carcass plies in the bead area of the tire. Their purpose is to protect the carcass plies from damage when mounting or demounting and to reduce the effects of wear and chafing between the wheel and the tire bead.

**The liner** in tubeless tires is a layer of rubber specially compounded to resist the permeation of nitrogen and moisture through to the carcass. It is vulcanized to the inside of the tire and extends from bead to bead. It replaces the inner tube common to tube-type tires.

All Michelin manufactured Radial aircraft tires are certified for in-service operation to -55°C. Beginning with manufactured date, June 1999, all Michelin Bias aircraft tires are certified for in-service operation to -55°C.

In tube-type tires, a different, thinner liner material is used to protect the carcass plies from moisture and tube chafing, but is generally insufficient to maintain air retention.

**The sidewall** is a layer of rubber covering the outside of the carcass plies. Its purpose is to protect the cord plies. In addition, the sidewall rubber contains anti-oxidants. They are slowly released over time to protect the tire from ultraviolet and ozone attack, which cause rubber cracking.

# Aircraft tire construction

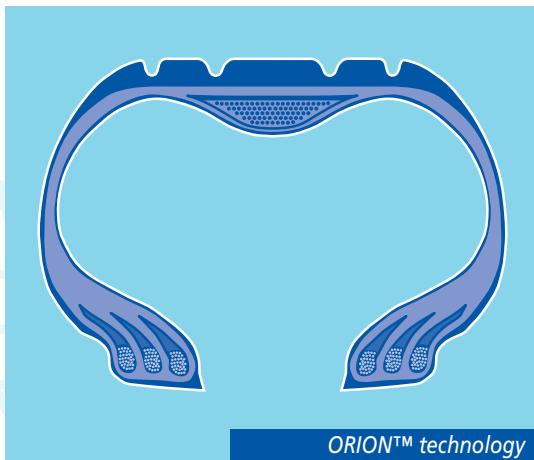

ORION™ technology

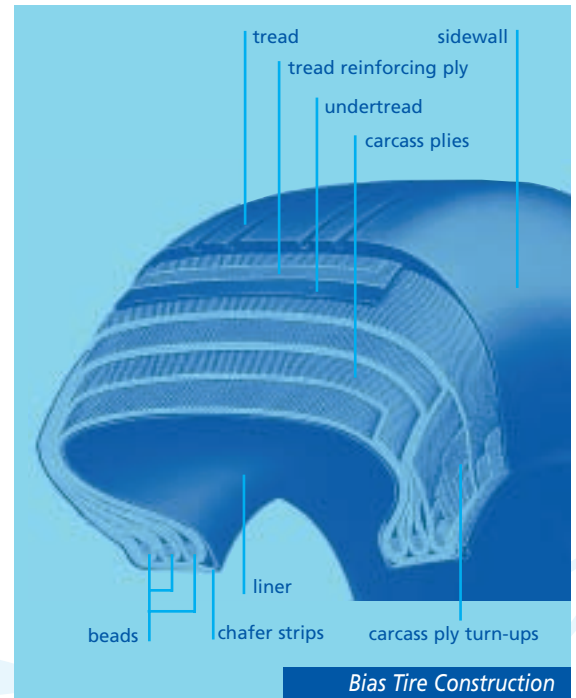

Bias Tire Construction

## Products unique to the bias tire

**The tread reinforcing ply** consists of single or multiple layers of a special nylon fabric and rubber laid midway beneath the tread grooves and top carcass ply. These plies help to strengthen and stabilize the crown area, by reducing tread distortion under load, and to increase high speed stability. They also offer a resistance to tread puncture and cutting and help to protect the carcass body.

**Breaker plies** (not shown) are sometimes used to reinforce the carcass in the tread area of the tire.

**ORION™ technology** is a development unique to Michelin Bias construction. It consists of a CROWN REINFORCEMENT placed on the inside of the tire. This CROWN REINFORCEMENT strengthens and provides a more uniform pressure distribution in the footprint SLOWING THE RATE OF WEAR, improving landings performance in a lighter tire design.

**Fabric tread** (not shown) is a unique development for application on high speed military aircraft. Multiple plies of nylon cord are layered throughout the tread stock, reducing rubber distortion under load and high speeds, thus reducing heat normally generated by flexing. The laminates also control the formation of high speed “standing waves.” Improved resistance to cuts and punctures is also a benefit of this type of construction.

**Spiral Wrap** (not shown) is a technique used with retreaded tires. Individual textile cords are laid within the replacement tread rubber as it is applied to the tire casing. Cords are oriented to the top 1/2 - 1/3 of the skid and are free to “float.” Because of their circumferential orientation, the textile cords provide added resistance to the cutting and tearing action associated with chevron cutting.

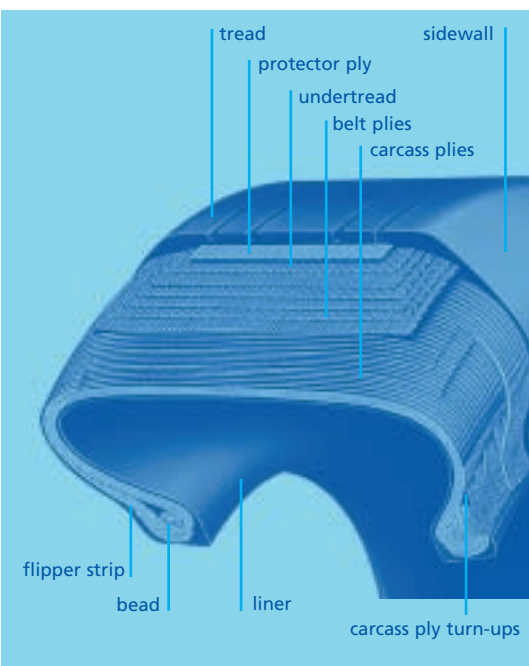

Radial Tire Construction

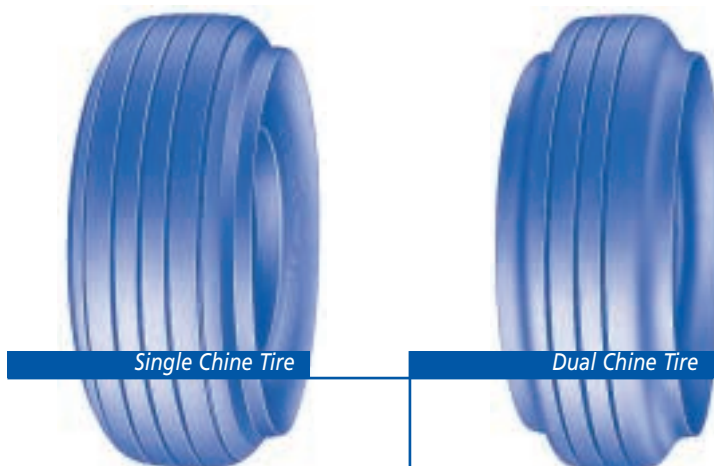

## Products unique to the radial tire

**The protector ply** is typically found in retreadable tires and placed in the crown area just below the tread rubber. It provides cut resistance protection to the underlying belts and carcass plies.

**Belt plies** are laid between the tread area and top carcass ply. They restrain the outer diameter of the tire, providing a tread surface with greater resistance to squirm and wear as well as providing a more uniform pressure distribution in the footprint for improved landings performance.

## Chine tires

The “chine” tire is a nose wheel tire designed to deflect water and slush to the side and away from intakes on aft-fuselage mounted jet engines.

It consists of a flared upper sidewall protrusion which deflects the spray pattern of water or slush displaced by the tire’s contact with the runway. A tire can have a single chine (one sidewall flared) for dual nose wheel tire configurations or double chines (both sidewalls flared) for single nose wheel tire configurations.

The chine tire is now in use as standard equipment on many commercial jets. It is fully retreadable and may be used on any aircraft provided adequate clearance is available.

# Branding

## commercial bias tire

typical Michelin branding layout

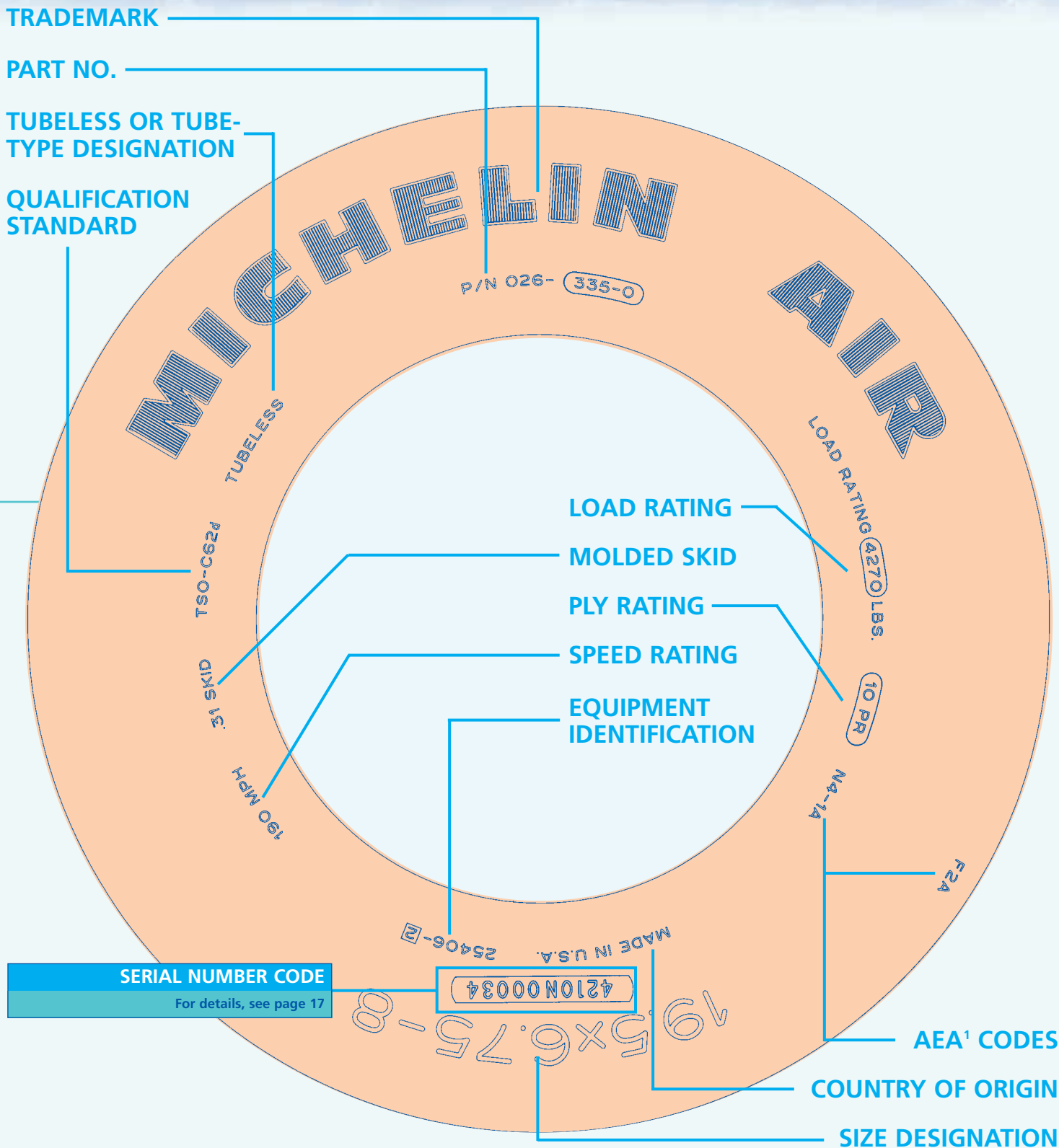

1. AEA: Association of European Airlines

# Branding



MICHELIN AIRCRAFT TIRE

## commercial radial tire

typical Michelin branding layout

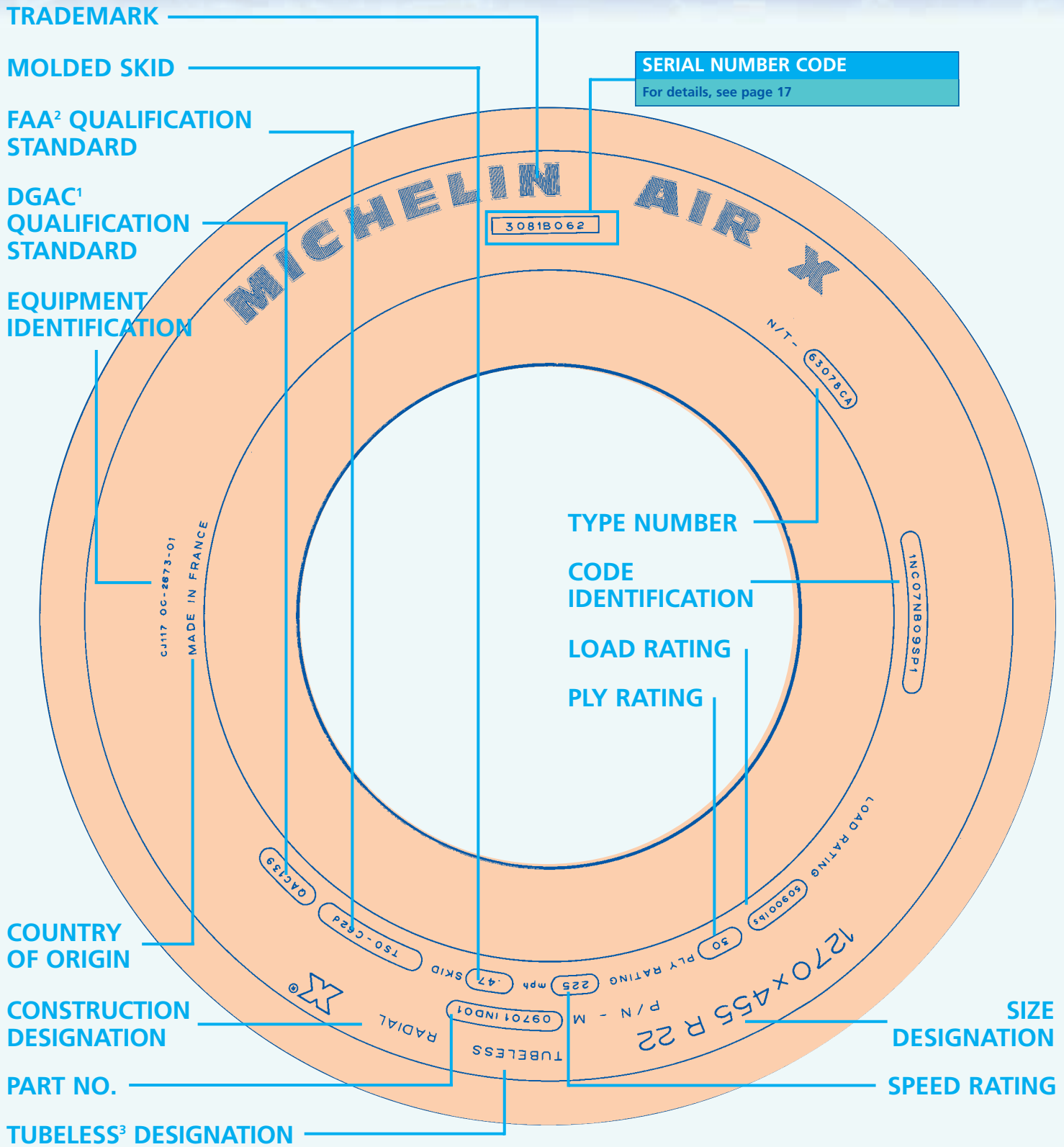

1. DGAC: Direction Générale de l'Aviation Civile / 2. FAA: Federal Aviation Administration / 3. All MICHELIN aircraft radials are tubeless

# Branding

## military bias tire

typical Michelin branding layout

TRADEMARK

EQUIPMENT IDENTIFICATION

QTR NO.

CUT LIMITS

SERIAL NUMBER CODE

For details, see page 17

MAXIMUM WEAR LIMIT INDICATOR

Application is program dependant

COUNTRY OF ORIGIN

SCD<sup>1</sup> NO. OR MS<sup>2</sup> NO.  
OR OEM<sup>3</sup> SPECIFICATION NO.  
OR USAF<sup>4</sup> NO.

TUBELESS OR  
TUBE TYPE  
DESIGNATION

CODE IDENTIFICATION

NATIONAL OR NATO STOCK NUMBER

PART NO.

SIZE DESIGNATION

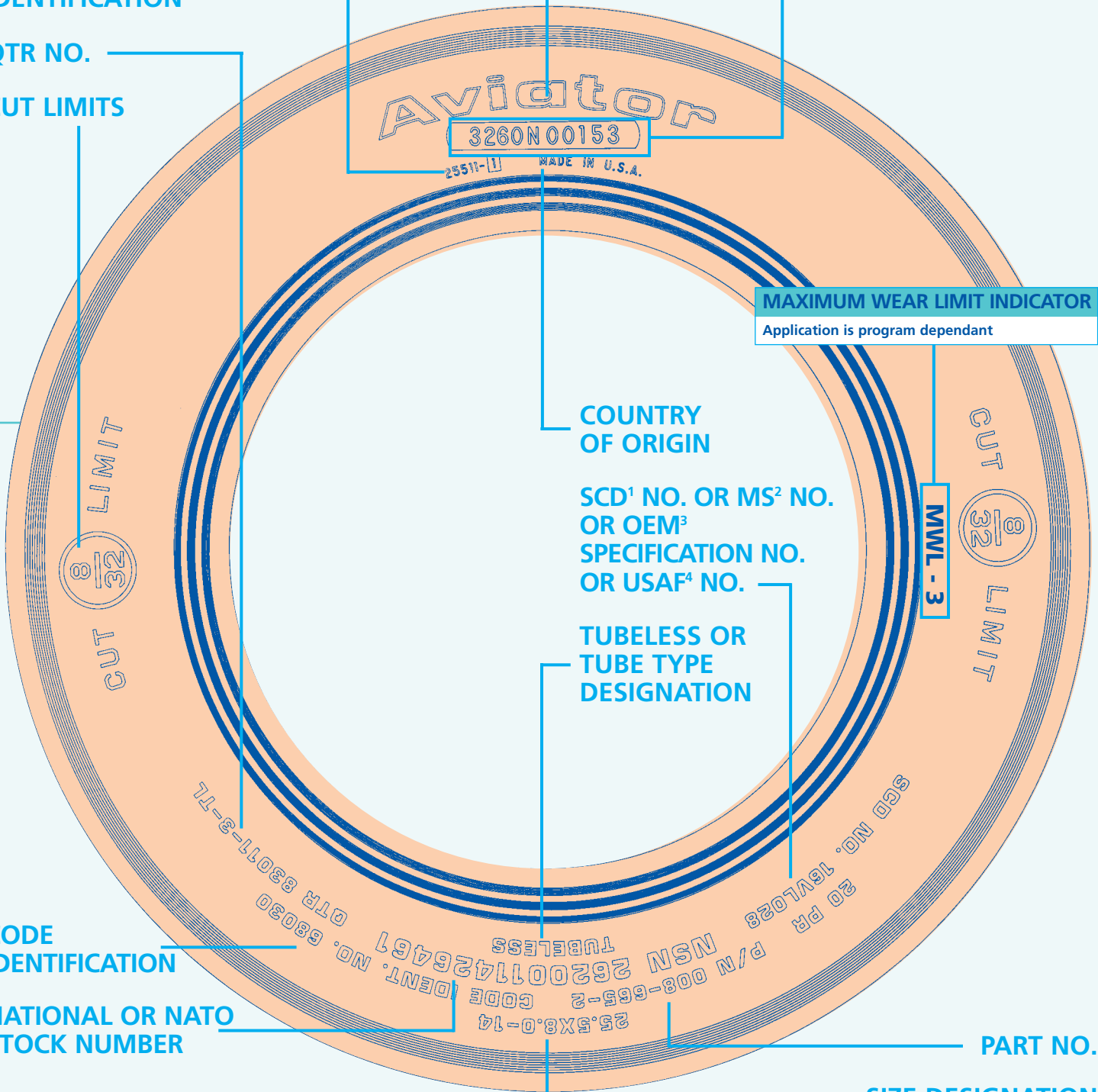

1.SCD: Specification Control Drawing / 2.MS: Military Specification / 3.OEM: Original Equipment Manufacturer / 4. USAF: U.S. Air Force

# Branding



## military radial tire

typical Michelin branding layout

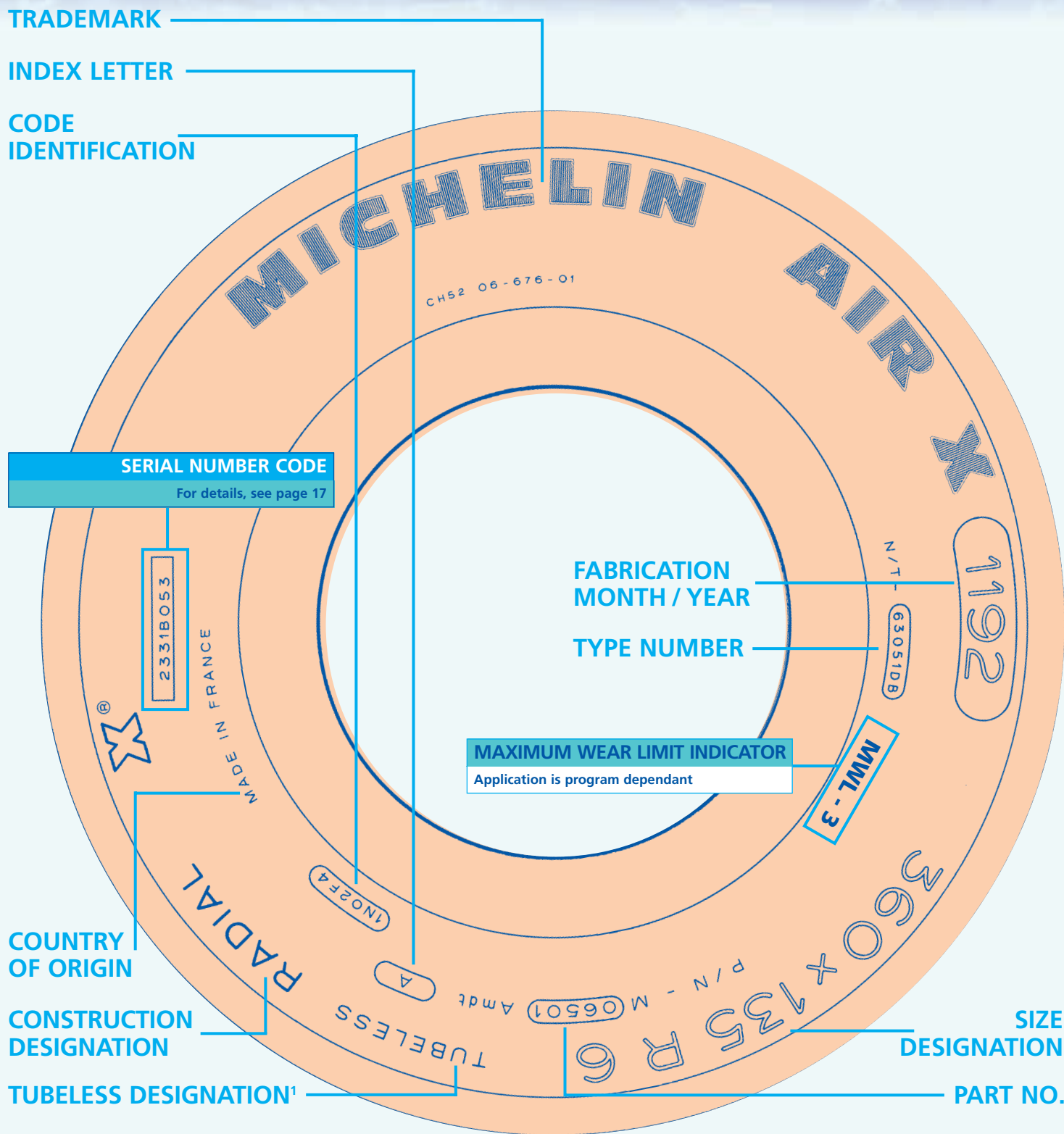

1. All MICHELIN aircraft radials are tubeless

# Branding

## bias retread tire

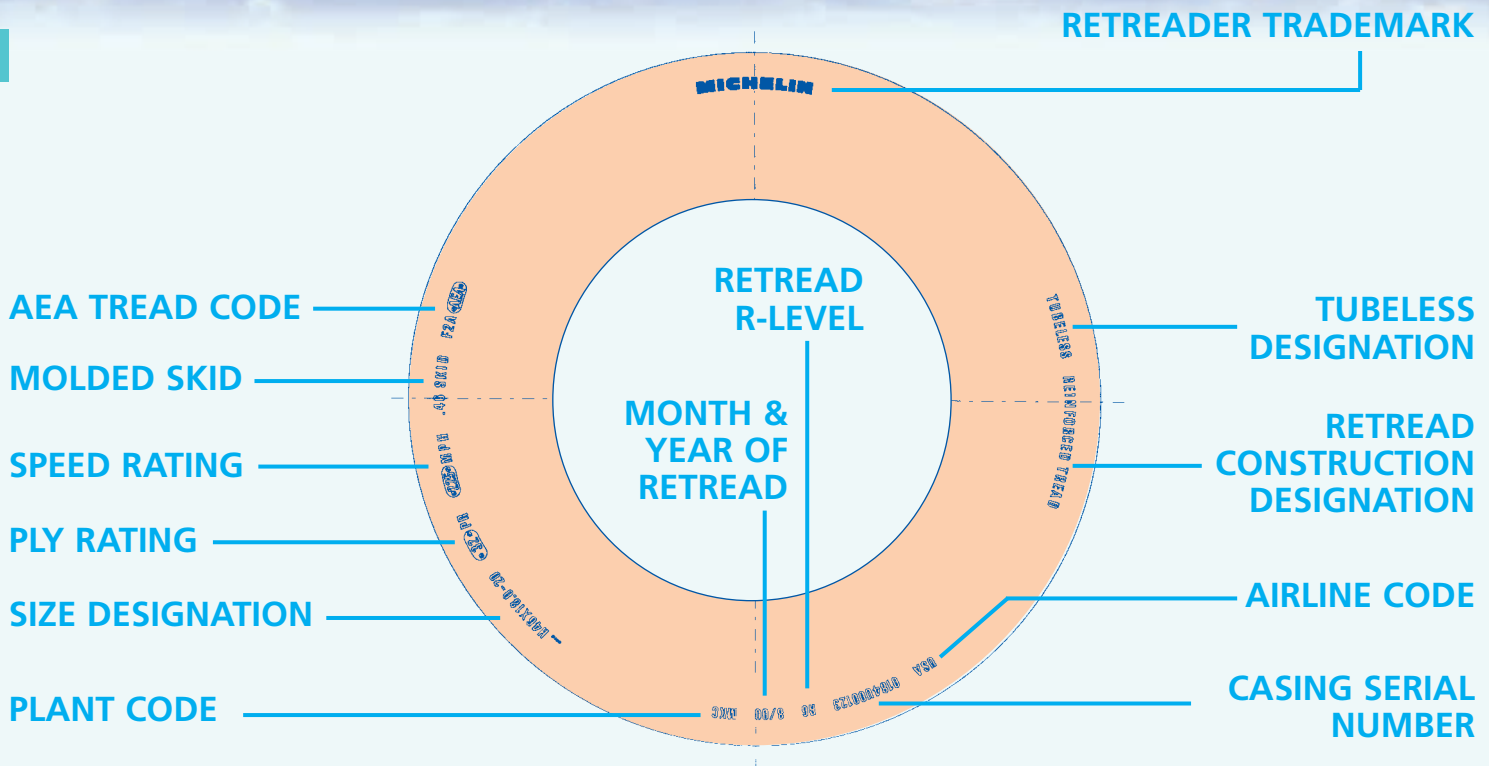

# Branding

## radial retread tire

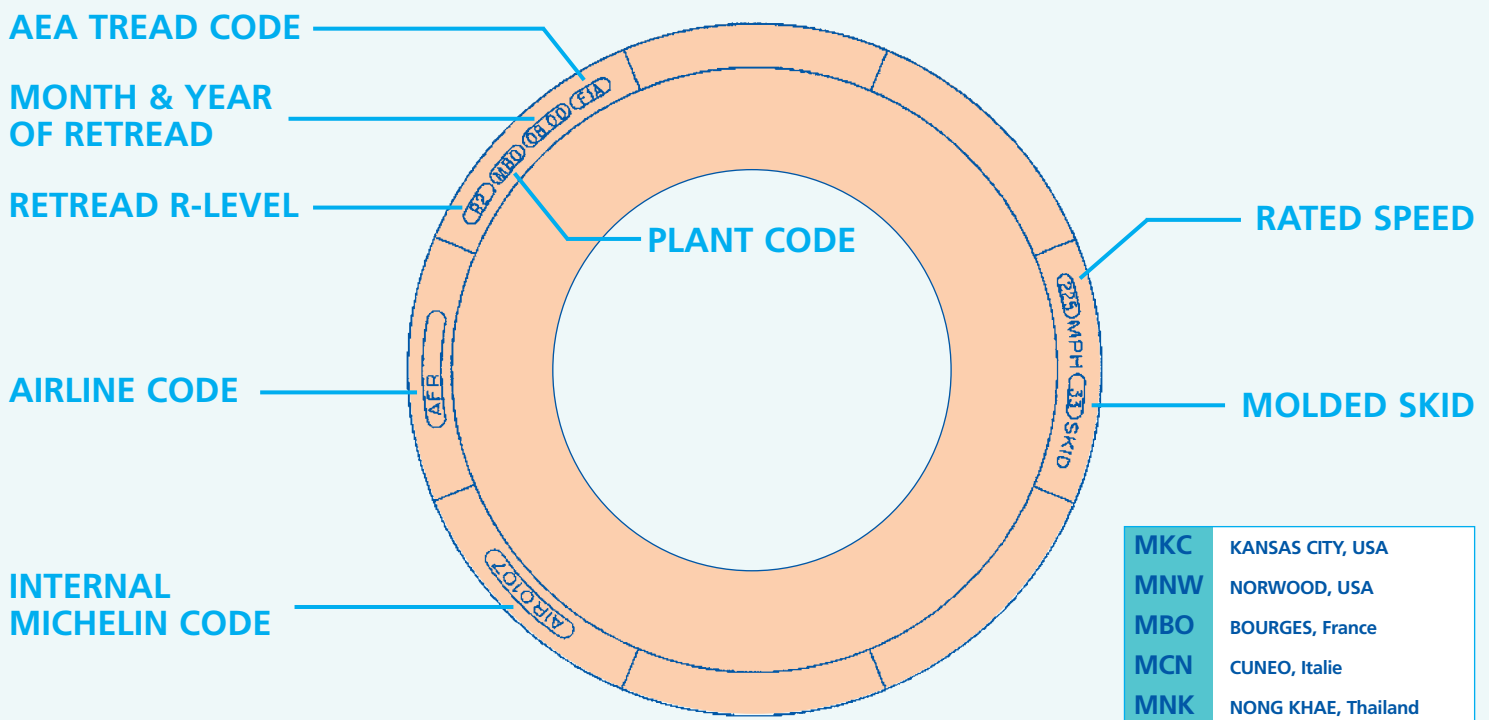



# Michelin tire



MICHELIN AIRCRAFT TIRE

## serial number codes

### Radial serial number definition:

**9 2 1 1 B 0 2 5**

Last number of the manufacturing year (example: 9 for 1999).

3 numbers indicating the manufacturing day in Julian calendar (example: the tire was manufactured the 211th day of the year).

Code letter related to the facility and the decade, see table below.

Unique production identification number.

### Bias Serial Number Definition:

**9 2 1 1 P 0 0 0 2 5**

Last number of the manufacturing year (example: 9 for 1999).

3 numbers indicating the manufacturing day in Julian calendar (example: the tire was manufactured the 211th day of the year).

Code letter related to the facility and the decade, see table below.

Unique production identification number.



### Letter signification

The letter code in the tire serial number is used to identify both the manufacturing facility and the decade of manufacture. It follows the rules below:

Manufacturing Facility	Through Dec. 31, 1995 included	From Jan. 01, 1996 to Dec. 31, 1999 included	from Jan. 01, 2000 to Dec. 31, 2009 included
<b>Bourges</b>	B	B	A
<b>Clermont-Ferrand</b>	F	F	G
<b>Greenville</b>	K	K	L
<b>Nong Khae</b>	T	T	W
<b>Norwood</b>	N	P	U

## General safety considerations



**IMPORTANT:**  
*In the event of a conflict between recommended procedures, be sure to contact your Michelin representative before undertaking the procedure in question.*

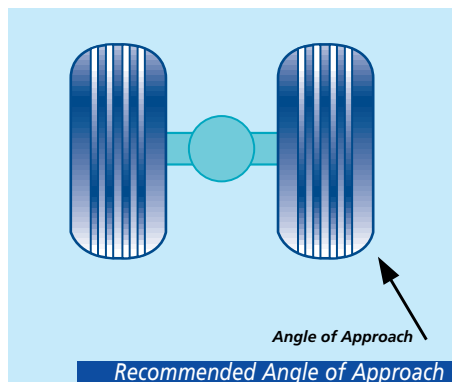

*Aircraft tire and wheel assemblies must operate under high pressures in order to carry the loads imposed on them. They should be treated with the same respect that any other high pressure vessel would be given. Following the recommended procedures given throughout this manual, as well as those provided by authorities such as wheel manufacturers, air-framers and industry regulatory agencies, will minimize the risks and chance of injury.*

## Mounting

Follow the instructions given in the section on “General Mounting Instructions For Aircraft Tires”. Be particularly attentive when:

- Rolling tires on the floor and using mechanical lifting equipment to avoid possible back injuries.
- Inspecting tires and wheels in advance for possible shipping damage.

## Inflating

- When inflating tires, be sure to use a suitable inflation cage.

- Keep pressure hose and fittings used for inflation in good condition.
- Allow the tire to remain in the inflation cage for several minutes after reaching full inflation pressure.
- Respect inflation pressures and all other safety instructions.

## Tires in service

- Careful attention should be shown to tire/wheel assemblies being handled or in storage.
- Never approach a tire/wheel assembly mounted on an aircraft that has an obvious damage until that tire has cooled to ambient temperatures (allow at least 3 hours).
- Always approach a tire/wheel assembly from an oblique angle, in the direction of the tire’s shoulder.
- Deflate tires before removing them from the aircraft unless the tire /wheel assembly is to be immediately remounted on the aircraft, such as with brake

inspections. Deflate tires before attempting to dismount the tire from the wheel or before disassembling any wheel component. Show caution when removing valve cores as they can be propelled at a high speed from the valve stem.

- **The transportation of a serviceable** aircraft tire/wheel assembly should be in accordance with the applicable regulatory body for the airline. Transportation of a serviceable inflated aircraft tire is covered by the U.S. Department of Transportation Code of Federal Regulations, the International Air Transport Association (IATA), and other regulatory bodies.
- While serviceable tires may be shipped fully pressurized in the cargo area of an aircraft, Michelin’s preference is to reduce pressure to 25% of operating pressure or 3 bars / 40 psi, whichever is the lesser.
- Remove from service tire/wheel assemblies found with one or more tie bolt nuts missing.

## **Storing aircraft tires and tubes**





Tire can be lifted through center

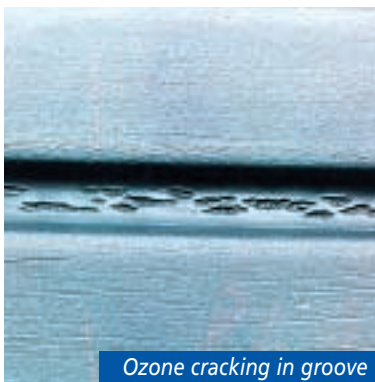

Ozone cracking in groove



Typical ozone cracking

*Tires are designed to be tough, durable and to withstand large loads and high speeds. They can provide years of reliable service if a few precautions are followed.*

*The ideal location for tire and tube storage is a cool, dry and reasonably dark location, free from air currents and dirt. While low temperatures (not below 0°C/32°F) are not objectionable, room temperatures above 40°C / 104° F are detrimental and should be avoided.*

## Handling aircraft tires

Care should be shown when handling aircraft tires. While tough and durable, tires can be damaged or cut by sharp objects or if excessive force is used. Avoid lifting tires with conventional two prong forks of material handling trucks. Damage to bead mounting areas or the innerliner can occur. A wide, flat, pincher type fork assembly of the type that lifts the horizontal tire by squeezing against the tread surface is recommended. An alternate recommended method would be to use a rounded bar to lift the tire

through the center. Avoid the use of forks or other objects which have corners that could damage the bead surfaces. When possible, handle tires by lifting or rolling.

## Avoid moisture and ozone

### Ozone - What is it ?

Ozone is a gas, a form of oxygen. In the earth's atmosphere, where it occurs naturally in small amounts, ozone plays a crucial geophysical role because of its intense absorption of solar ultraviolet radiation. Additional ozone, created when industrial exhaust mixes with ultraviolet rays, can be harmful. Ozone degrades organic matter, such as rubber.

### Impact of ozone on tires

Most of the natural and synthetic elastomers used in aircraft tires are susceptible to ozone attack. Ozone in the air readily reacts with the double bonds (unsaturation) in the rubber molecules. The result of this reaction is the breaking of

molecular bonds and a degradation of the rubber, which lead to crack initiation. Continued stress, and especially cyclic stress, causes the crack to grow until it is visible as the characteristic surface crack, perpendicular to the direction of the applied stress.

## Designing for ozone

To aid in the control of ozone attack on rubber, the tire materials specialist adds waxes and protective chemicals. Some of these ingredients address ozone attack when the tire is in a static state at room temperature; other ingredients are activated by heat and protect the tire once it is in service. Further, the tire designer is mindful of the impact of shapes and contours on stress concentrations. Still, steps need to be taken in storage to delay the effects of ozone attack. Wet or moist conditions have a deteriorating effect on tires and tubes, and can be even more damaging when the moisture contains foreign elements that are further harmful to rubber and cord fabric.

# Storing aircraft tires and tubes



Protect tires from contaminants



Horizontal storage is not recommended



Store tires vertically in racks

Strong air currents should be avoided, since they increase the supply of oxygen and quite often carry ozone, both of which cause rapid aging of rubber.

Particular care should be taken to store tires and tubes away from fluorescent lights, electric motors, battery chargers, electric welding equipment, electric generators and similar electrical devices, since they all create ozone.

## Store away from fuel and solvents

Make sure that tires do not come into contact with oil, gasoline, jet fuel, hydraulic fluids or other hydrocarbon solvents, since all of these are natural enemies of rubber and cause it to disintegrate rapidly. Be especially careful not to stand or lay tires on floors that are covered with oil or grease. When working on engines or landing gears, **tires should be covered** so that oil does not drip on them.

If tires accidentally become contaminated, wash them off with denatured alcohol and then with a soap and water solution. After cleaning, be sure to remove any water that may have accumulated in the interior of an unmounted tire. If after cleaning, the surface of the tire appears soft, or spongy, or bulges are present, the tire is not suitable for service. Should you have any doubt about the serviceability of such a tire, please contact your Michelin Representative or authorized repair station.

## Store in the dark

The storage room should be dark, or at least free from direct sunlight. Windows should be darkened with a coat of blue paint or covered with black plastic. Either of these will provide some diffused lighting during the daytime. Black plastic is preferred since it will lower the temperature in the room during the warm months and permit tires to be stored closer to the window.

**Fluorescent or mercury vapor lights should not be used** because they generate ozone. Low intensity sodium vapor lights are recommended. See the section on "Ozone" for more information.

## Stores tires vertically

Whenever possible, tires should be stored in regular tire racks which hold them up vertically. The surface of the tire rack on which the weight of the tire rests should be flat and, if possible, 3 to 4 inches / 7.5 to 10 cm wide to prevent permanent distortion of the tire.

## Horizontal stacking of tires is not recommended

If tires are stacked horizontally, they may become distorted, resulting in mounting problems. This is particularly true of tubeless tires. Those on the bottom of a stack may have the beads pressed so closely together that bead spreader tools will have to be used to properly space the beads for contact with the wheel during initial inflation.



Tires which are stacked on top of each other, sidewall-to-sidewall, have increased stresses in the tread grooves. If tires are stored for an extended period of time, or in an environment with high ozone concentration, ozone cracking is most likely to form in the tread grooves.

If tires must be stacked, they should not be stacked for more than 6 months maximum. The maximum stacking height:

- 3 tires high if tire diameter is greater than 40 inches / 1 meter.
- 4 tires high if tire diameter is less than 40 inches / 1 meter.

### Store tubes properly

Michelin tubes should always be stored in their original cartons, so they are protected from light and air currents. If stored without their cartons, they should be wrapped in several layers of heavy paper. Tubes can also be stored by inflating slightly (not more than 0.06 bar / 1 psi) and inserting them in the same size tire. This, of course, should only be

done as a temporary measure. Before mounting a tire and tube stored in such a manner, always remove the tube from the tire and inspect the inside of the tire for foreign material, which, if not cleaned out, could cause irreparable damage to both tube and tire. Under no circumstances should tubes ever be hung over nails or pegs, or over any other object which might form a crease in the tube. Such a crease will eventually produce a crack in the rubber and cause tube failure.

### Tire or tube age limit

Michelin aircraft tires or tubes have no age limit and may be placed in service, regardless of their age, provided all inspection criteria for service/storage/mounting and individual customer-imposed restrictions are met.

**Note:** Certain regulatory agencies recommend further restricting the age of rubber products used in the aircraft industry. The decision to adopt these recommendations must be made by the individual user.

### Storage of inflated tire and wheel assemblies

Mounted tire/wheel assembly properly prepared and delivered to a line maintenance station as an airworthy replacement unit may be stored at full operational pressure for up to 12 months, see comments in the section on tire mounting found later in this manual.

## Aircraft tires and ozone





## Recommendations for storage and handling

*The following storage and handling conditions are strongly recommended to minimize the damaging effects of ozone:*

### Location:

- Inside a warehouse away from direct sunlight or precipitation. (Wet or moist conditions can carry other chemicals which can have a further damaging effect on tires.)

### Storage Area Environment:

- Temperatures should remain between 0°C/32°F and 40°C/104°F.
- Use reasonably low intensity lighting (sodium vapor lamps are preferred).
- Environment should be free of strong air currents and excessive dirt.

### Ozone Sources:

- Store away from fluorescent lighting, mercury vapor lamps, electric motors, battery chargers, electric welding equipment, and electric generators.

### Tire Storage:

- Stand the tire such that it rests on its tread, whether on the floor or in a rack.
- This orientation should be used for any tire which will be held in storage for more than 1 months time. (Storage racks should provide an adequate amount of surface area to support the tire to prevent a distortion or “set” from occurring in the tread area).
- If high ozone concentrations can not be reduced or eliminated, each tire should be protected by appropriate wrapping such as dark polyethylene or paper.

### Mounted Tire:

- Mounted tires not immediately placed in service should be covered or wrapped until they are to be installed on an aircraft.
- To minimize the effects of ozone attack and where re-inflation capability exists, tire pressure may be reduced to a value below operational pressure, but not less than 25% of the operational pressure or 40 psi / 3 bars, whichever is less.

# *General mounting*

## **General mounting instructions for aircraft tires**





Wheel half and O-Ring

## General

*Proper mounting procedures simplify the job of servicing aircraft tires, while at the same time increasing safety and reducing the chances of damaging tires or wheels. Do not mount aircraft tires without the proper equipment, instructions, and operator training.*

*Be sure to know and understand all chemicals used on the tire and wheel. It is possible that under the high pressures and load exerted by the tire on the wheel, normally inert chemicals may contribute to rapid corrosion and/or abrasion of the wheel, or deterioration of the rubber surface.*

*Virtually all modern aircraft wheels are of two types: split wheel type, i.e., two “halves” joined by removable tie bolts, or the removable flange type. Both designs facilitate the mounting (and dismounting) of the tire. Show careful attention in handling, assembling and disassembling wheel components to avoid damage to critical surfaces.*

## Premounting checklist

### Wheels

*Careful attention to details is necessary to successfully mount aircraft tires for trouble-free service. Make sure you are thoroughly familiar with and inspect all key wheel parts before beginning to mount a tire.*

*To assist in this process, wheel manufacturers publish specific instructions in their maintenance and overhaul manuals. Follow their recommendations and procedures for wheel assembly and disassembly to obtain trouble-free mounting and dismounting.*

***Direct particular attention to the following:***

- **Ensure that the bead seating** area of the wheel is clean and uncontaminated.
- **Mating surfaces of the wheel** halves should be free of nicks, burrs, small dents, or other damage that could prevent the surfaces from properly mating or sealing. Painted or coated surfaces should be in good condition; not badly chafed, chipped, etc.
- **Be sure fuse plugs**, inflation valves and wheel plugs are in good condition, properly sealed against loss of pressure and correctly torqued per the manufacturer’s instructions.
- **O-Ring grooves in the wheel** halves should be checked for damage or other debris that would prevent the O-Ring from properly seating.

# General mounting instructions for aircraft tires

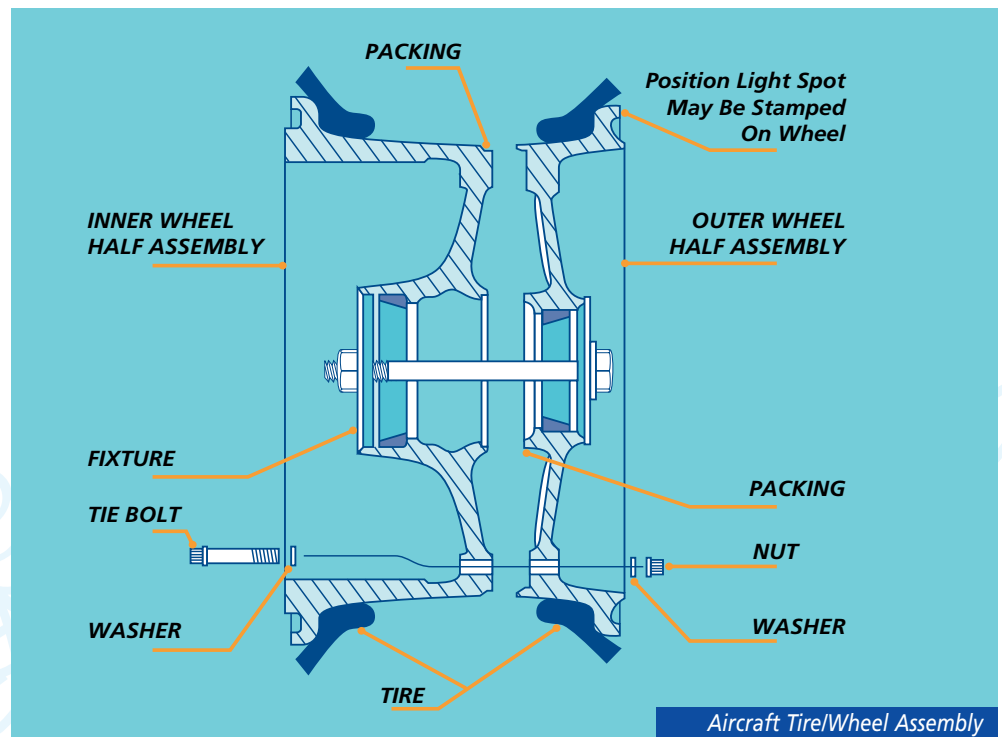

● **O-Rings themselves must be of the proper material**, as specified by the wheel manufacturer, for the intended application and temperature conditions. Inspect O-Rings for cracking, cuts, or other damage. Particular attention should be given to permanent deformations in the O-Ring. O-Rings found with deformations should be replaced. Proper sealing of the wheel halves is critical in providing trouble-free service.

● **Should the inspection of a used O-Ring** for its integrity not be practical or manageable, replace with a new O-Ring with each tire change.

## Tires

Before mounting any tire, verify that the tire is correct for the intended application. Use the following checklist:

- **Check that the tire markings** are correct for the required application (size, ply rating, speed rating, part number, TSO marking).
- **Visually inspect the outside of the tire for:**
  - Damage caused by improper shipping or handling of the tire.
  - Cuts, tears or other foreign objects penetrating the rubber.
  - Permanent deformations.
  - Debris or cuts on the bead seating surfaces. Clean the tire bead surfaces with either a clean shop towel, a soap/water solution, or with denatured alcohol as may be necessary.
  - Bead distortions.
  - Cracking that reaches cords.

● Contamination from foreign substances (oil, grease, brake fluid, etc.) which can cause surface damage (blisters or swelling).

● **Inspect the inside of the tire** to be sure there is no foreign material present. Be sure that the inner liner condition is good, that is, without wrinkles. Check for liner damage caused by improper shipping or handling of the tire.

*Refer to the section on "Tire Serviceability Criteria" for damages. If in question, tires should not be used and should be returned to a certified repair or retread station for further inspection and disposition.*



## Mounting

### Use of Inner Tubes

#### Bias Tires

All Michelin bias or cross ply tires, whether tube-type or tubeless, are suitable for operation with tubes approved for the particular tire size and application on tube-type wheels.

#### Radial Tires

All Michelin radial tires are of tubeless design. Never use an inner tube or mount on a tube-type wheel.

### Lubrication of Tire Beads

#### Bias Tires

Because of their typically wide bead flat, when installing bias tires on aluminum wheels, lubricate the toes of the beads with an approved 10% vegetable oil soap solution.

***Do not use lubricant with magnesium alloy wheels!***

***Lubricants manufactured from a petroleum base are not recommended as hydrocarbons have a known detrimental effect on rubber compounds.***

#### Radial Tires

For radial tires, use of a mounting lubricant is not specified, unless approved by the airframer.

### Tire/Wheel Assembly

**Again, be sure that the wheel, tire, and assembly components are in good condition and free of debris.**

**Lubricate the O-Ring** (as specified by the wheel manufacturer) and install in the wheel groove or channel. Be sure the O-Ring is free of kinks or twists.

**Position the previously inspected tire in front of the first wheel half.** If a bias tire, lubricate the beads as required. Slide the tire on the wheel.

**When mounting tube-type tires,** dust the tube and the inside of the tire with tire talc or soapstone before installing the tube. This will prevent the tube from sticking to the inside of the tire or to the tire beads. Dusting also helps the tube assume its normal shape inside the tire during inflation, and lessens the chances of wrinkling or thinning from irregular stretching. (Caution: Use care not to damage tube when mounting.)

*To be consistent with the practice of mounting the tire serial number to the outboard wheel half, tubes should be installed in the tire with the valve projecting on the serial numbered side of the tire.*

**Assemble the two wheel halves,** being sure to align the light point of each half 180° apart to insure the optimum balance of the assembly.

*When aligning the wheel halves, be careful not to damage the O-Ring in the wheel base which seals the wheel halves.*

# General mounting instructions for aircraft tires

**WARNING!**  
*Aircraft tires can be operated up to or at rated inflation pressure; extremely high inflation pressures may cause the aircraft wheel or tire to explode or burst, which may result in serious or fatal bodily injury. Aircraft tires must always be inflated with a properly regulated inflation canister. The high pressure side should never be used. The safety practices for mounting and dismounting aircraft tires detailed in this Manual must be followed.*



Tire balance mark

## Tire/Wheel Alignment for Balance

The “red” balance mark on the lower sidewall indicates the light point of the tire’s balance. Align this mark with the heavy point of the wheel.

In the absence of a balance mark, align the tire’s Serial Number with the heavy point of the wheel (main landing gear position tires only).

Many wheel manufacturers today identify either the light spot or heavy spot of the wheel with markings in the flange area. Follow their instructions on assembly and balance. Be sure to align the tire’s light spot 180° from the wheel’s light spot or directly in line with the wheel’s heavy spot. In the absence of specific wheel markings, align the tire’s red balance mark with the wheel inflation valve.

Some aircraft tubes feature balance marks to indicate the heavy portion of the tube. These marks are approximately 1/2” wide and 2” long. When inserting the tube in the tire, its balance mark should be aligned with the balance mark on the tire. If the tube has no balance mark, align the valve with the balance mark on the tire.

A properly balanced tire/wheel assembly improves the tire’s overall wear characteristics. In addition to severe vibration, an unbalanced assembly will cause irregular and localized tread wear patterns that can reduce the overall performance life of the tire.

**Be sure that nuts, washers, and bolts** are installed in proper order and that the bearing surfaces of these parts are properly lubricated as required. Tighten to manufacturer’s recommended torque values.

**After the tire is mounted on the wheel**, the assembly should be placed in a safety cage for inflation with nitrogen. It is recommended that the cage be placed against an outside wall that is strong enough to withstand the effects of an explosion of either the tire, tube or wheel.

*The inflation pressure source should be located 10 meters / 30 feet away from the safety cage with a valve, regulator and pressure gauge installed at that point. The inflation line should then be run to the safety*

*cage and attached to the wheel valve. This arrangement allows the tire service person to inflate the tire safely using the remote valve.*

## Inflating With Nitrogen

Many regulatory agencies require the use of nitrogen when inflating tires for aircraft above a specified Maximum Take-Off Weight (MTOW). Michelin recommends the use of a dry, commercial grade nitrogen of at least 97% purity when inflating all aircraft tires. Nitrogen provides a stable, inert inflation gas while eliminating the introduction of moisture into the tire cavity.

**Aircraft operating procedures** for initial inflation and adjustments must comply with applicable instructions as given in FAR 25 or JAR 25.

Oxygen concentration should never exceed 5%.



MICHELIN AIRCRAFT TIRE

## Basic Pressure Retention Procedure

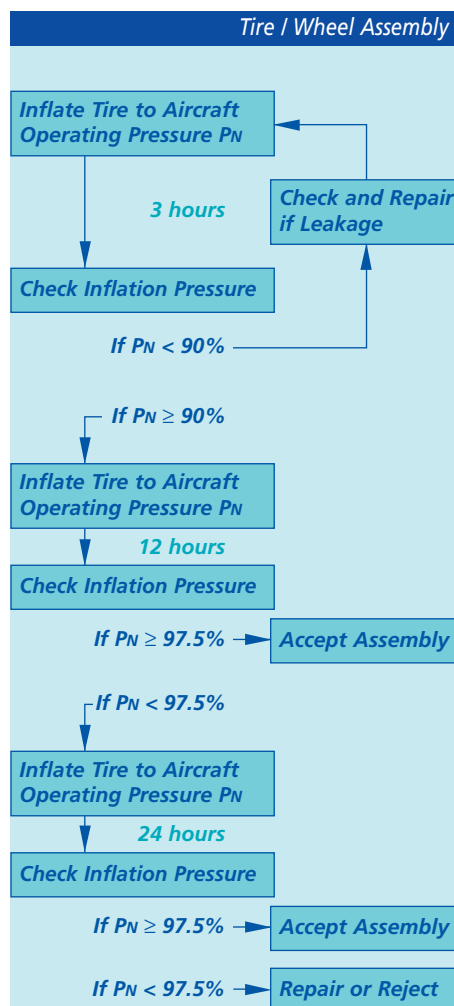

## Special Procedure To Properly Seat Tube-Type Tires

To seat tire beads properly on the wheel:

- Inflate the tire to the recommended pressure for the aircraft on which it is to be mounted.
- Next, completely deflate the tire.
- Finally, reinflate it to the correct pressure (do not fasten the valve to the rim until this has been done). Use a valve extension for inflation purposes if necessary.

This procedure helps remove any wrinkles in the tube and helps prevent pinching the tube under the toe of the bead. It eliminates the possibility of one section of the tube stretching more than the rest and thinning out in that area. Further, it assists in the removal of air that might be trapped between the inner tube and the tire.

**Note:** With tubeless tires, this inflation-deflation-reinflation procedure is not necessary.

## Basic pressure retention check

*Pressure retention checks are designed to verify that tire/wheel assemblies meet industry standards for pressure retention prior to releasing them for service on aircraft. This important process assures reliable service and avoids costly returns for repairs. This basic pressure retention check requires approximately 15 hours to determine if an assembly can be accepted for service. Additional checks are performed on tire/wheel assemblies not meeting the minimum acceptance criteria for pressure loss.*

To follow this procedure requires a pressure gauge of 0.25% accuracy or better and capability to indicate 2 psi / .15 bar pressure change.

### Procedure:

- 1 Inflate the newly mounted tire/wheel assembly to operating pressure for the aircraft application as specified in shop instruction manuals.

**For safety: use a suitable metal inflation cage when inflating tires.**

- 2 Store the inflated tire/wheel assembly for 3 hours.
- 3 Check inflation pressure: Be sure that the ambient temperature of the tire/wheel assembly has not changed by more than 3°C/5°F.  
**Options:**
  - If inflation pressure is equal to or greater than ( $\geq$ ) 90% of the specified operating pressure, proceed to Step 4.
  - If inflation pressure is less than ( $<$ ) 90% of the specified operating pressure, inspect the assembly for leakage. Use a soap solution on tire beads and other susceptible wheel components (valves, fuse plugs, over-pressurization plugs, wheel half parting line, etc.). If soap bubbles or leaks are found, make appropriate repairs. Return to Step 1.
- 4 Re-inflate the tire to the specified operating pressure.

# General mounting instructions for aircraft tires

## Emergency Pressure Retention Procedure

### Tire / Wheel Assembly

Inflate Tire to Aircraft Operating Pressure  $P_N$

Within 30 minutes

Spray with leak detection solution

- If bubbles are found on wheel hardware or a stream of bubbles at tire vents...
- If no bubbles are found at plugs, valves, "O-rings", or no stream of bubbles at tire vents...

Submit assembly for Basic pressure check

Install Tire on Aircraft at Operating Pressure  $P_N + 5\%$  (unloaded)

Check Inflation Pressure before each flight over the next 48 hours

If  $P_N \geq 90\%$

Accept Assembly

If  $P_N < 90\%$

Remove the assembly (and mate) per the inflation pressure maintenance schedule

### Emergency pressure retention check:

The following procedure may be used to perform a pressure retention check on a newly mounted tire/wheel assembly when time does not allow the basic procedure to be applied. Note this procedure recommends a tire inflation check be performed before each flight during the first 48 hours after the assembly has been put into service.

- 5** After 12 hour storage period, check inflation pressure: Be sure that the ambient temperature of the tire/wheel assembly has not changed by more than 3°C/5°F.

#### Options:

- If inflation pressure is equal to or greater than ( $\geq$ ) 97.5% of the specified operating pressure, **accept** the tire/wheel assembly for in-service usage or line maintenance storage (see Storage Section for recommendations on line maintenance storage).

**Note:** Re-inflate tire to the specified operating pressure.

- If inflation pressure is less than ( $<$ ) 97.5% of operating pressure, inspect the assembly for leakage. Use a soap solution on tire beads and other susceptible wheel components (valves, fuse plugs, over-pressurization plugs, wheel half parting line, etc.).

If soap bubbles or leaks are found, make appropriate repairs. Proceed to step 6.

- 6** Re-inflate the tire to the specified operating pressure.

- 7** After a 24 hour storage period, check inflation pressure. Be sure that the ambient temperature of the tire/wheel assembly has not changed by more than 3°C/5°F.

#### Options:

- If inflation pressure is equal to or greater than ( $\geq$ ) 95% of the specified operating pressure, **accept** the tire/wheel assembly for in-service usage or line maintenance storage (see Storage Section for recommendations on line maintenance storage).

**Note:** Re-inflate tire to the specified operating pressure.

- If inflation pressure is less than ( $<$ ) 95% of operating pressure, **reject** the tire/wheel assembly.

### Alternate pressure retention check

This alternate, historical, procedure is designed to provide a more complete check of tire/wheel assembly pressure retention prior to releasing them for use on aircraft. The procedure is particularly beneficial when in-service pressure retention issues have been encountered.

#### Procedure

##### • Allow for Tire Growth

Newly mounted tire/wheel assemblies should stand for 12 hours to allow for normal tire growth (cord body stretching) and to verify that the assembly is without leaks. After 12 hours, inspect the assembly carefully. Check the tire pressure drop. A 10% drop during tire growth is considered normal. More than that may indicate a leakage problem. Be sure that the tire assembly has remained at a constant ambient temperature ( $\pm$  3°C/5°F). A drop of 3°C/5°F will reduce inflation pressure 1%.





Sidewall vent holes

### ● Check for Leakage

After the growth period, reinflate the tire to the specified operating pressure. Recheck the pressure after a 24-hour period. A pressure loss of 5% or less is considered normal. Be sure that the ambient temperature of the tire has not changed by more than 3°C/5°F. If a greater than 5% pressure loss occurs, investigate the tire/wheel assembly for leaks. Do not put the tire into service until the leak source is identified and corrected. If the pressure loss is within the acceptable 5% limit, the assembly is now ready to be installed on the aircraft.

Note that once in service, the tire/wheel assembly maximum daily (24 hours) pressure loss is 5%. Typical rates are 0.2-2.0% per 24-hour period.

### Sidewall venting

Aircraft tires have traditionally been designed to permit any air or nitrogen trapped in the cord body or that diffuses through the liner or tube to

escape through special sidewall vents. Tires requiring vent holes have them placed in the lower sidewall. This venting prevents pressure build-up within the carcass body which might cause tread, sidewall, or ply separations. The location of each vent hole on the new tire is indicated by a colored paint dot. Simply apply a soap solution to these vent markings. The appearance of small bubbles will indicate diffusion. **This bubbling is normal** and may be seen at any time while the tire is inflated. Maximum allowable diffusion is 5% for any 24-hour period. Pressure losses in excess of 5% may indicate leakage from other sources. In that case, the tire and wheel assembly should be carefully tested for leaks, preferably by total immersion, before placing it into service. If no assembly leaks are found, dismount and have the tire inspected by the manufacturer or a qualified repair shop.

**Note:** Do not identify a tire as a leaker solely on the rate of bubbles from these vent holes. A high rate of bubble venting is not always an indicator of tire leakage. It is best to judge excessive leakage of a tire/wheel assembly based on pressure loss as measured with a calibrated gauge, preferably the same gauge used to initially inflate the tire.

### Not all aircraft tires are vented

Improvements in materials, tire design and fabrication make the need for lower sidewall venting unnecessary for all aircraft tires. This is particularly true for the physically smaller tires such as General Aviation and High Performance Military tires.

**Knowing which tires have been vented** is important. Tires requiring lower sidewall vents will have either a green or white paint dot applied to the area of each vent hole. Tires not needing lower sidewall vents will have no color dot in this zone.

# General mounting instructions for aircraft tires

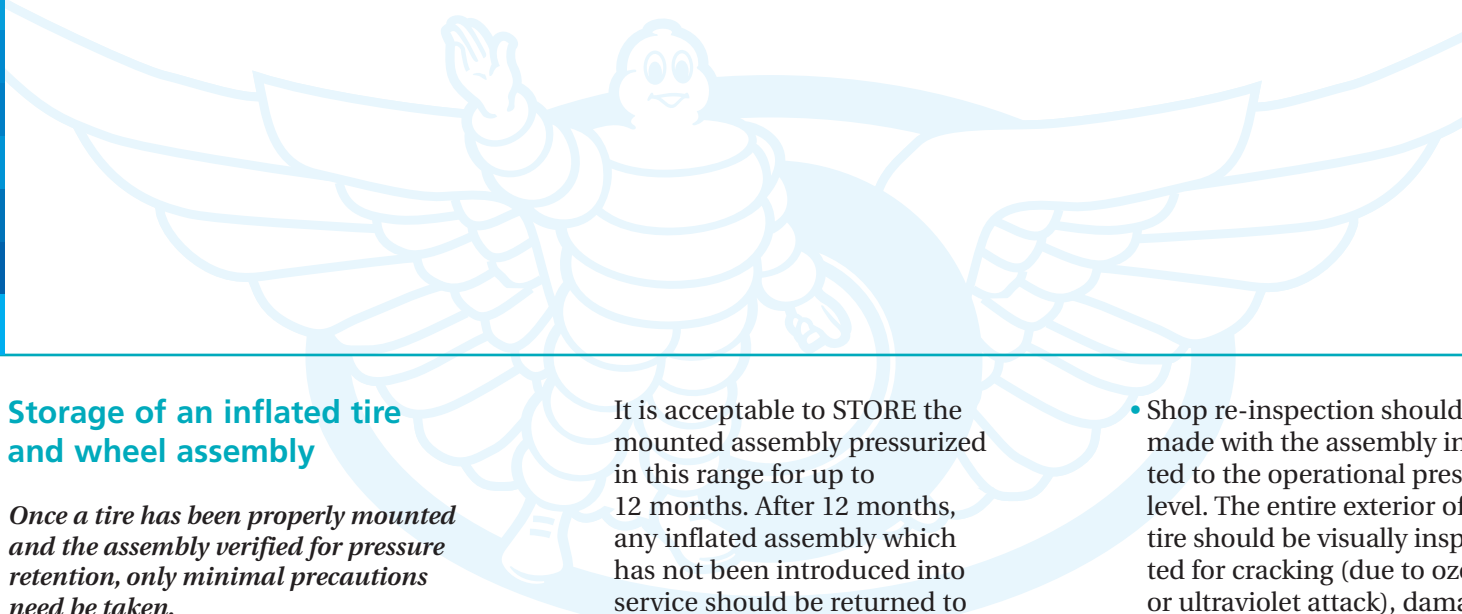

## Storage of an inflated tire and wheel assembly

*Once a tire has been properly mounted and the assembly verified for pressure retention, only minimal precautions need be taken.*

- **Do not expose the tire** to excessively high temperatures (greater than 40° / 104° F).
- **Do not expose the tire** to direct sunlight or to high ozone concentrations.
- **Avoid contact** with contaminants (oil, grease, etc.).
- **A Mounted tire/wheel assembly** properly prepared and delivered to a line maintenance station as an airworthy replacement unit should meet the following storage conditions:
  - The pressure level should be set at operational pressure for the tire application. Do not exceed operational pressure.

It is acceptable to STORE the mounted assembly pressurized in this range for up to 12 months. After 12 months, any inflated assembly which has not been introduced into service should be returned to the wheel mounting shop.

The following inspections and actions should be taken with the assembly before returning it to service. This storage and re-inspection interval can be repeated multiple times so long as the tire meets all criteria. However, to maximize tire life, it is recommended to rotate replacement stock.

**Note:** The conditions of storage, and the tire's response to those conditions, will determine whether a stored, inflated tire is still airworthy. Time should not be the measure by which a tire is classified unserviceable.

- Shop re-inspection should be made with the assembly inflated to the operational pressure level. The entire exterior of the tire should be visually inspected for cracking (due to ozone or ultraviolet attack), damages, or any other condition. If the limits given in the chapter on "Tire Serviceability Criteria" have been exceeded, dismount the tire from the wheel and return to the supplier.

Subject the assembly to the standard air retention test to verify that the assembly will still meet the criteria of no more than 5% pressure loss in a 24 hour period.

While in storage, if the assembly inflation pressure was being maintained using compressed air, deflate the assembly and re-inflate with nitrogen (per industry standards).



Having met each of the above conditions, return the tire/wheel assembly to stock.

**Note:** The criteria for re-inspection of the wheel must also be determined before returning the assembly to service.

- To minimize the effects of ozone attack and where re-inflation capability exists, tire pressure may be reduced to a value below operational pressure, but not less than 25% of the operational pressure or 40 psi / 3 bars, whichever is less.

● **Transportation of a serviceable** aircraft tire/wheel assembly should be in accordance with the applicable regulatory body for the airline.

Transportation of a serviceable inflated aircraft tire is covered by the U.S. Department of Transportation Code of Federal Regulations, the International Air Transport Association (IATA), and other regulatory bodies.

While serviceable tires may be shipped fully pressurized in the cargo area of an aircraft, Michelin's recommendation is to reduce pressure to 25% of operating pressure or 3 bars / ~40 psi, whichever is the lesser. Reinflate to operating pressure before mounting on the aircraft.



# *Mounting on aircraft*

36

## **Mounting tire/wheel assembly on the aircraft**





## Visually Inspect Tire/Wheel Assembly

**Visually Inspect Tire/Wheel Assembly** for damage from handling, storage, or contaminants. Look for deformations, bulges, swelling, blisters, or other anomalies that would make the assembly unserviceable.

- Superficial cuts or cracks not reaching the cord body are acceptable for service.
- Groove cracking that does not reach the protector or reinforcing ply is acceptable for service.

*Follow the guidelines given in this Manual for serviceability.*

## Readjust Tire Pressure

**Readjust Tire Pressure** after mounting the tire/wheel assembly on the aircraft. Operating pressures are set by the airframe manufacturers based on a variety of factors including maximum ramp or taxi weight, center of gravity and dynamic loading. Reference the Operator's Manual for the particular aircraft.

### *Important:*

- *Check pressure with aircraft load on tire.*
- *Use loaded operating inflation pressure.*
- *Operational pressure values are for loaded tires.*
- *Loaded inflation pressure = 104% unloaded inflation pressure.*

# *Inflation pressure maintenance*

38

**Inflation**

**pressure maintenance**





## Proper inflation - getting the most out of your tires

*The most important service you can perform on your aircraft's tires is to make sure they are properly inflated at all times. The more often you use the aircraft, the more often the tires need checking. It is the Key to Optimum Service.*

If you make one or more flights a day, tire pressure should be checked **daily**, with an accurate, calibrated gauge (preferably with a dial or digital indicator appropriate for the pressure range of your tires). When installed, the TPIS (Tire Pressure Indicator System) can be used to make the daily inflation pressure check, provided the TPIS indicators are verified against a calibrated pressure gauge at each aircraft "A" check.

If you fly less than one time per day, you should check tire pressure before each flight.

Be particularly alert to severe temperature drops, which will also reduce tire pressure. Repeated pressure losses beyond the daily 5%, under constant temperature conditions, may signal a slow leak in the tire/wheel assembly.

To **avoid false readings**, tire pressure should be checked on "cool" tires (air in a hot tire will expand, causing a temporary higher pressure reading). Wait at least 3 hours after landing or until the tire has reached ambient temperature as noted by carefully feeling with the palm of the hand, before making pressure checks.

If it is absolutely necessary to check pressures when tires are **hot**, compare the relative pressures between tires on the same landing gear positions (main or nose). **Never bleed pressure from a hot tire** [See "Checking Hot Tires" later in this section for details].

## Effects of Underinflation

Too little pressure can be harmful to your tires and dangerous to your aircraft and those in it. Underinflated tires can creep or slip on the wheel under stress or when brakes are applied. Valve stems can be damaged or sheared off and the tire, tube, or complete wheel assembly can be damaged or destroyed. Excessive shoulder wear may also be seen.

Underinflation can allow the sidewalls of the tire to be crushed by the wheel's rim flanges under landing impact, or upon striking the edge of the runway while maneuvering. Tires may flex over the wheel flange, with the possibility of damage to the bead and lower sidewall areas. The result can be a bruise, break or rupture of the cord body. In any case where the bead or cord body of the tire is damaged, the tire is no longer safe to use and must be replaced.

# Inflation

## pressure maintenance

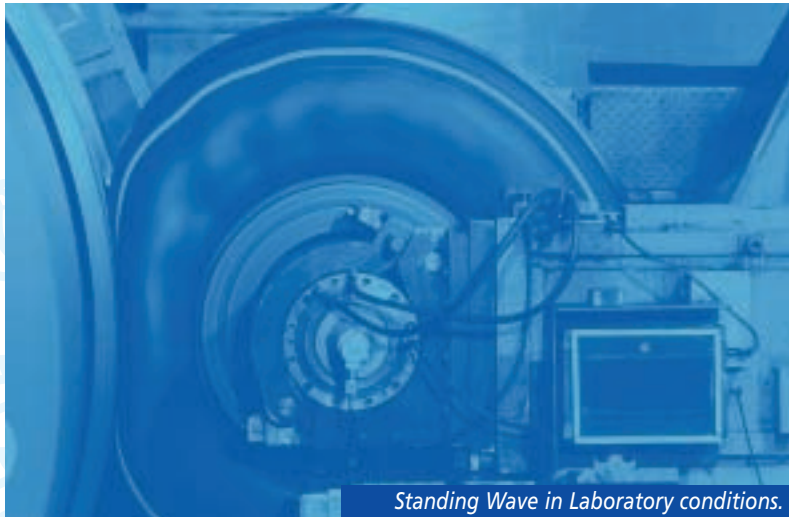

Standing Wave in Laboratory conditions.

Severe underinflation may cause ply separation and carcass degradation because of the extreme heat, the strain caused by the excessive flexing action, or the occurrence of premature standing waves (see photo). This same condition can cause inner tube chafing and a resultant blowout.

In dual tire applications, underinflation of one tire causes the other tire to carry a disproportionate amount of load. As a result, both tires can be deflected considerably beyond their normal operating range, potentially causing ply separations and/or carcass degradation.

### Effects of Overinflation

Tires operating under too much inflation pressure are more susceptible to bruising, cuts and shock damage. Ride quality as well as traction will be reduced. Continuous high pressure operation will result in poor tire wear characteristics (center wear) and reduced landings performance.

***WARNING! Aircraft tires can be operated up to or at rated inflation pressure. Extremely high inflation pressures may cause the aircraft wheel or tire to explode or burst, which may result in serious or fatal bodily injury. Aircraft tires must always be inflated with a properly regulated inflation canister. The high pressure side should never be used. The safety practices for mounting and dismounting aircraft tires detailed in this Manual must be followed.***

### Checking Duals for Equal Operating Pressure

Tires mounted as duals or on the same bogey, whether main or nose, whether bias or radial, should be maintained at equal operating pressure. If pressures are not equal, the tire with the highest pressure will be carrying an unequal proportion of the load even though there may be no perceptible difference between tire deflections. The graph on page 41 demonstrates this concept.

If it is determined that dual-mounted tires are operating at unequal pressures (more than 5% is cause for special attention), inflate both tires to their proper pressure. Make a logbook entry indicating the original pressure differential, the date and time corrected and the ambient temperature. At each subsequent pressure check, the logbook should be consulted.



### Effects of Unequal Tire Pressure on Tire Loads

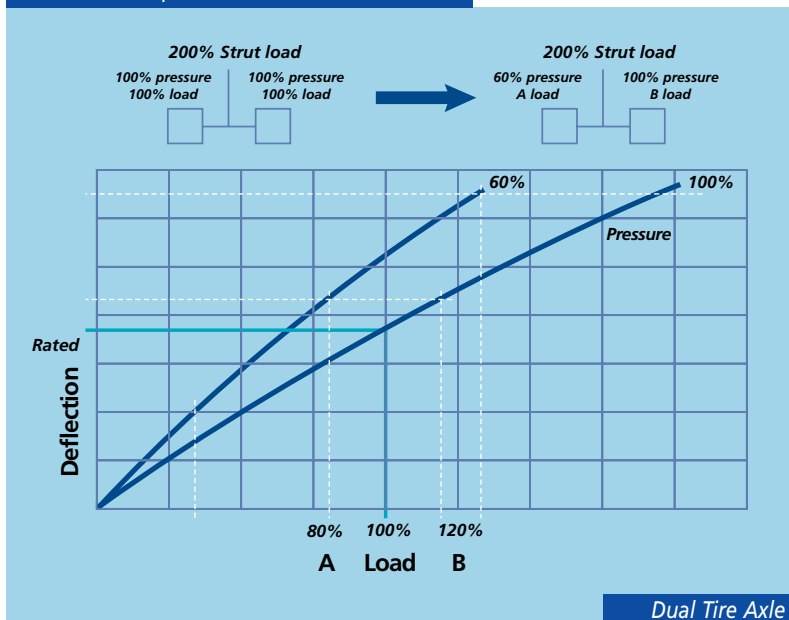

Dual Tire Axle

If the same tire continues to evidence a pressure loss, it should be checked for leakage (FOD, valve core, etc.). If no obvious cause is found, the tire should be removed and given a thorough inspection until the reason for the pressure loss can be determined.

For mixability of bias and radial tires, see the section on “Matching Dual Tires” in this manual.

### Proper Inflation - Setting the Pressure Level

#### Inflating and Reinflating the Tire/Wheel Assembly

Whether for tubeless or tubetype, tire operating pressures should be set following the instructions given by the airframe manufacturer. For newly mounted tires, follow the instructions given in the section on “General Mounting Instructions For Aircraft Tires.”

When required, reinflate tires to their specified operating pressure with a dry, commercial grade nitrogen of at least 97% purity.

In some cases, nitrogen may not be available for adjusting tire inflation. When this occurs, clean dry air may be used as long as the oxygen content does not exceed 5% of the total tire volume. If the 5% oxygen limit is exceeded, the tire must be deflated and then reinflated with nitrogen to the specified operating pressure.

***WARNING! In the event of excessive heat build-up in the tire/wheel assembly (example, locked brakes), hydrocarbons released by the tire may spontaneously ignite in the presence of oxygen.***

***A tire filled with air can explode, causing injury to persons and damage to equipment.***

### Loaded versus Unloaded Tires

Be sure that it is clear whether operating inflation pressures are given for loaded or unloaded tire conditions. A tire’s inflation pressure when loaded will be 4% higher than when unloaded (Loaded pressure = 1.04 x unloaded pressure).

### Properly Inflating Tube-Type Tires

Air is usually trapped between the tire and the tube at the time of mounting. Although initial readings indicate proper pressure, the trapped air will seep out around the valve stem hole in the wheel, and under the beads. Within a few days, as the tube expands to fill the void left by the trapped air, the tire may become severely underinflated. To compensate for this effect, check tire pressure before each flight for several days after installation, adjusting as necessary, until the tire maintains proper pressure.

# Inflation

## pressure maintenance

Metric Units						
Temperature Rise °C	Δ50		12.9	14.1	16.4	17.6
	Δ40		12.5	13.7	15.9	17.1
	Δ30		12.1	13.2	15.5	16.6
	Δ20		11.8	12.8	15.0	16.0
	Δ10		11.4	12.4	14.5	15.5
		<b>Specified Operating Pressure (bars)</b>	11	12	14	15
Temperature Drop °C	Δ10		10.6	11.6	13.5	14.5
	Δ20		10.2	11.2	13.0	14.0
	Δ30		9.9	10.8	12.5	13.4
	Δ40		9.5	10.3	12.1	12.9
	Δ50		9.1	9.9	11.6	12.4

Units in °C and Bars

### Effect of ambient temperature on gauge pressure

#### Effect of Temperature

Watch for severe changes in ambient temperature. Changes in temperature affect gauge pressure readings as follows:

**1% change (increase) in inflation pressure reading for every 3°C/5°F change (increase) in temperature.**

The above charts are a helpful example of the change in inflation pressure readings as a result of a change in ambient temperature. For convenience, it is given in metric units and in customary units.

Customary Units						
Temperature Rise °F	Δ100		192	216	240	264
	Δ80		186	209	232	255
	Δ60		179	202	224	246
	Δ40		173	194	216	238
	Δ20		166	187	208	229
		<b>Specified Operating Pressure (bars)</b>	160	180	200	220
Temperature Drop °F	Δ20		154	173	192	211
	Δ40		147	166	184	202
	Δ60		141	158	176	194
	Δ80		134	151	168	185
	Δ100		128	144	160	176

*Units in °F and PSI*

### Proper Inflation – Standard for Maintaining Pressure Level

A “cold” tire is defined as a tire which has come to equilibrium with its operating environment (ambient temperature).

While the actual (ambient) temperature of the “cold” tire will vary from location to location and from season to season, the operational inflation pressure (PN), as specified by the airframe manufacturer for each aircraft configuration, is necessary to carry the load of the aircraft. **This pressure value is therefore needed regardless of the ambient temperature.** For example, if PN = 12 bars / 175 psi, this is the pressure needed at **any** ambient temperature.

**Note:** Do not reduce the pressure of the “cold” tire subjected to frequent changes in ambient temperature.

*[Refer to P. 44 for additional guidance.]*

### Aircraft experiencing large ambient temperature differences between airports

Large temperature differences place a special burden on aircraft operations. As can be seen in the chart above, large changes in ambient temperature will result in corresponding changes in gauge pressure. Aircraft flying long distances where a large (>30°C/54°F) decrease in ambient temperature will occur need to apply specific inflation maintenance procedures. One of two options should be selected in this situation:

- In the event that pressure maintenance is not available at the destination airport, raise the operating inflation pressure (PN) by 1% for each 5° F / 3° C temperature drop relative to the departure airport to insure adequate inflation pressure in the assembly at the destination airport.

**Note:** Do not exceed maximum rated loaded tire pressure.

or

- When pressure maintenance is available at the destination airport, check and readjust to operating inflation pressure (PN) prior to the next flight.

In all other cases, maintain the inflation pressure per the standard recommendation.

# Inflation

# pressure maintenance

## Schedule and action

Measured Pressure as % of Operating Pressure	Tire Condition	Course of Action
More than 105	Overinflated	<ul style="list-style-type: none"><li>● Because of variations in ambient temperature, gauge accuracy, etc., caution should always be shown before adjusting an overinflated pressure.</li><li>● It is recommended that the first overinflated reading be recorded in the aircraft log along with the ambient temperature. After the 2nd confirmed reading &gt;5%, readjust tire pressure to maximum of normal operating range.</li></ul>
105 - 100	Normal Operating Pressure Range	<ul style="list-style-type: none"><li>● Do not adjust tire pressure.</li><li>● Do not exceed tire's maximum rated pressure value (loaded), nor the wheel's TSO qualification pressure value (loaded).</li></ul>
100 - 95	Acceptable Daily Pressure loss	<ul style="list-style-type: none"><li>● Readjust tire pressure to maximum of normal operating pressure range.</li></ul>

Continued on page 45

## When to Check

### ● Frequency

Tires in service should have their "cold" inflation pressure checked daily to properly maintain operating pressures. For aircraft operating on a less frequent basis, inflation pressure should be checked before each flight.

When installed, the TPIS (Tire Pressure Indicator System) can be used to make the daily inflation pressure check, provided the TPIS indicators are verified against a calibrated pressure gauge at each aircraft "A" check. Understand that tires are capable of retaining pressure to tolerances which will keep them well within 5% of the specified pressure each day. Since pressure losses due to other causes can seriously affect performance and safety, it still remains a recommended practice to verify the pressure value at least daily.

### ● Checking Hot Tires

Knowing if the pressure of a hot tire is correct is nearly an impossible task. The air in a hot tire expands, causing a temporary higher pressure reading. The exact temperature is not known and thus the relative pressure is also unknown. As the tire cools, its pressure is also changing and will continue to do so until ambient temperature is reached.

A **hot tire** is one that has dynamically rolled under load on the aircraft and has **not been allowed to reach ambient temperature** (not been allowed to cool for at least three hours). Tires at elevated temperatures will develop inflation pressures higher than the specified cold inflation pressure.

Because of unusual circumstances, it may be necessary to check the pressure of a tire when it is hot. For example, check pressure if:

- tire shows excessive deflection
- flight schedules make it impossible to make a routine pressure check on a cool tire
- tire is continually exposed to direct sunlight.

While no precise procedure can be given for checking the pressure of a hot tire, the following instructions and precautions should be followed.



Measured Pressure as % of Operating Pressure	Tire Condition	Course of Action
Continued from page 44 94 - 90	<b>Accidental Pressure Loss</b>	<ul style="list-style-type: none"> <li>● Readjust tire pressure to maximum of normal operating pressure range.</li> <li>● Record in log book.</li> <li>● Recheck pressure after 24 hours.</li> <li>● If after 24 hours, pressure loss is again greater than the daily acceptable pressure loss (&gt;5%), remove tire/wheel assembly.</li> <li>● Inspect tire/wheel assembly for cause of pressure loss.</li> </ul>
89 - 80	<b>Pressure Loss</b>	<ul style="list-style-type: none"> <li>● Remove tire/wheel assembly from aircraft.</li> <li>● Reinflate to specified operating pressure.</li> <li>● If pressure loss is within daily acceptable pressure loss allowance (&lt;=5%), accept assembly.</li> <li>● If pressure loss is outside the daily acceptable pressure loss allowance (&gt;5%), inspect tire/wheel assembly for cause of pressure loss.</li> <li>● If the cause cannot be found, dismount tire for inspection by an authorized repair station.</li> </ul>
79 - 0	<b>Major Pressure Loss</b>	<ul style="list-style-type: none"> <li>● Remove the tire/wheel assembly.</li> <li>● Remove the adjacent tire/wheel assembly.</li> <li>● Replace tires*.</li> </ul>

*\* If it is known that a major pressure loss occurred while the aircraft was at rest or parked and the wheels did not turn with weight on them, the tire and the adjacent tire can be saved. If doubt exists, tag the tire(s) and have an authorized retread repair station inspect them.*

### ● Compare tire pressures on the same given landing gear

- Pressures measured from tires on the same landing gear should be of the same magnitude. They should always be at least equal to the specified operating pressure.
- If any tire is less than 90% of minimum loaded service pressure, remove the tire from service.

In such cases, note reason for removal and return the tire to an authorized repair facility for examination.

- Aircraft flying between airports with a significant temperature drop, should be aware of the effects of temperature on inflation pressure. See section "Effects of Temperature."

**Do Not Reduce The Pressure of a Hot Tire.**

The basic rules to follow for correcting inflation pressure of hot tires on the same landing gear:

- **Single and Multiple tire gear** - Should always be at least equal to, and may exceed, the specified operating pressure.
- **Two tire gear** - If one tire is approximately equal in temperature **but low in pressure** it should be **brought up to the pressure level of the other tire**. In all cases, both tires should be at least equal to or greater than the specified operating pressure.
- **Three or more tire gear** - Check all tires on the gear. Any tire that is approximately equal in temperature but low in pressure should have its inflation increased such that all tires are within a 5% pressure range. In all cases, all tires should be at least equal to or greater than the specified operating pressure.

**Note:** If one tire has an abnormally high pressure (>5%) as compared to the other tires on that gear, look for possible causes such as faulty brakes or incorrect pressure adjustment at previous check.

### Monitoring Inflation Pressure - What To Do

Checking and monitoring inflation pressure is usually performed on loaded tires. Be sure to know whether the operating inflation pressure is for loaded or unloaded tire conditions.

- **Loaded** inflation pressure is 1.04 x **Unloaded** inflation pressure.
- Use an accurate, calibrated gauge, preferably with a dial type indicator.
- **Watch** for changes in ambient temperature. A 3°C/5°F temperature change will result in a 1% tire pressure change.

# Inflation

## pressure maintenance

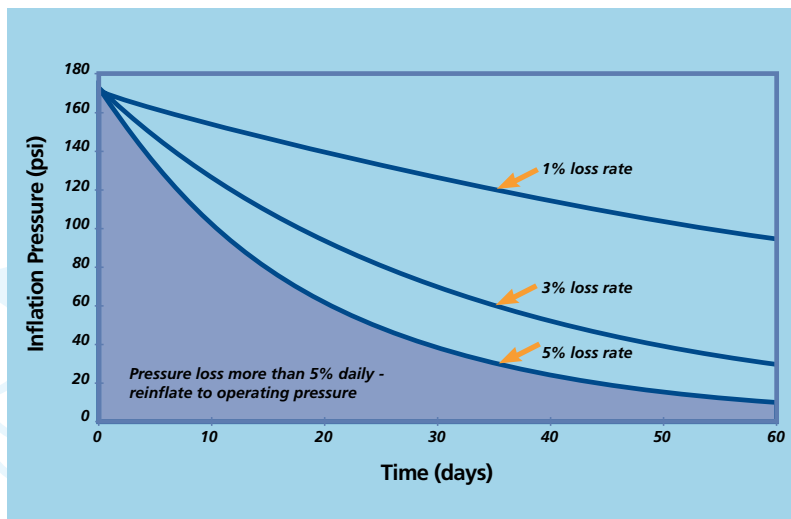

- When making tire pressure entries in the aircraft log book, it is best to record the ambient temperature along with the pressure readings.
- A recommended tracking system for daily pressure checks is to write tire pressure, ambient temperature and date on the sidewall of each tire during pressure monitoring. This method allows easy, quick follow-up on tire pressure conditions from line station to line station.
- Make sure tires have sufficient time to cool.
  - A cool tire is one at ambient temperature.
  - Allow 3 hours after landing, if not exposed to direct sunlight, for tires to properly cool. By carefully using the palm of the hand, it is possible to determine if a tire is cool or not.

- Note that operating pressures, whether loaded or unloaded, are specified for “cool” tires.
- The **maximum allowable pressure loss** for a tire is 5% for any 24-hour period.

### Pressure loss

#### Normal Response

The maximum daily pressure loss for a tire/wheel assembly is 5%.

The graph above shows how the normal pressure of a tire/wheel assembly can change with time even when no disruption in the sealing system exists. It demonstrates the importance of checking pressure when mounting a new assembly on the aircraft.



## Testing For Pressure Loss

*The source of a pressure loss can best be determined by applying a soap solution to suspected areas of leakage or by total immersion of the tire and wheel assembly in a water bath. Begin with the most simple checks first:*

- Check that the valve core is not leaking. Apply a small amount of soap solution on the end of the valve stem. If bubbles appear, replace the valve core and recheck. Be sure that the valve stem threads are not damaged. Otherwise, the valve core and the valve cap will not fit properly.

Each valve should have a valve cap on it to prevent dirt, oil, moisture and other contaminants from getting inside and damaging the core.

- Be sure that the valve is not bent or rubbing against the wheel. If damaged, dismount the tire and replace the tube or valve.

- Check the fuse plugs or pressure relief plugs with a soap and water solution. If bubbles appear, replace the valve core and recheck.
- Inspect the tread and sidewall areas for FOD's, cuts, snags, etc. Check suspected areas with a soap solution. If bubbles appear, the tire must be dismounted and repaired by a qualified repair station or scrapped.
- Totally immerse the tire/wheel assembly in a water bath. If a water bath is not available, apply a soap or other leak detector solution to the entire tire/wheel assembly. The appearance of bubbles at any point other than at the vents in the lower sidewall of the tire just above the wheel flange will indicate a leak.

*Note that nitrogen will diffuse through the sidewall vents for the entire life of an aircraft tire.*

Look closely for bubbles in the tubewell area of the wheel to be sure nitrogen is not leaking from any fatigue cracks or at the O-Ring seal of the wheel halves.

- If no leak source other than the sidewall vents can be found, it will be necessary to dismount the tire and make a further inspection.

# Inflation

## pressure maintenance

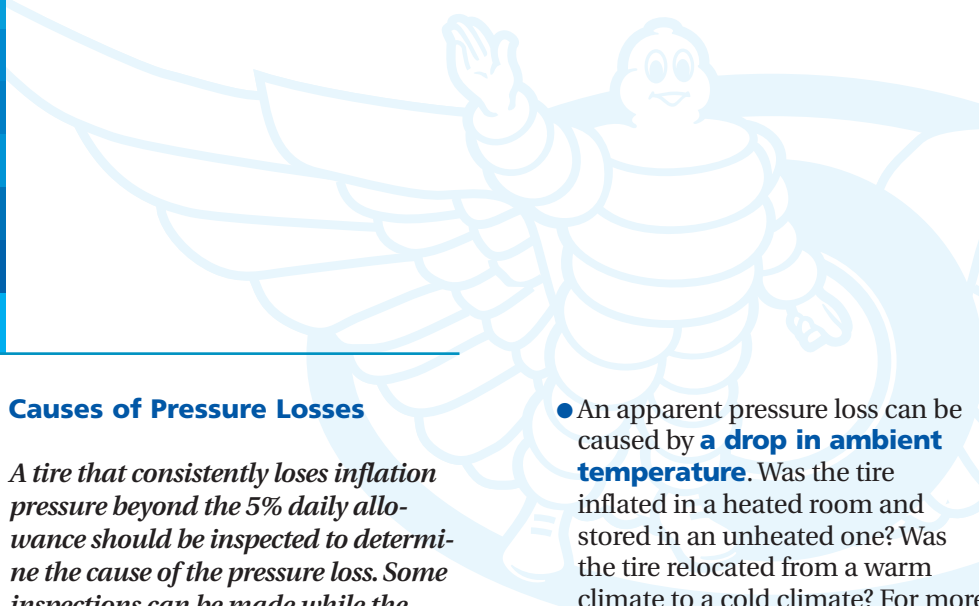

### Causes of Pressure Losses

*A tire that consistently loses inflation pressure beyond the 5% daily allowance should be inspected to determine the cause of the pressure loss. Some inspections can be made while the assembly remains mounted on the aircraft. Others will require the tire/wheel assembly to be dismounted from the aircraft and sent to the tire shop. Follow the guidelines given under the section “Monitoring Inflation Pressure - What To Do.”*

There are a number of possible causes of pressure loss in a tire:

- **Tire growth** during the first 12 hours after mounting and inflation to the specified operating pressure. This is entirely normal.
- To avoid a possible underinflation condition, it is important that a tire not be placed in service until it has undergone the complete growth cycle and has been reinflated to the specified operating pressure.

- An apparent pressure loss can be caused by a **drop in ambient temperature**. Was the tire inflated in a heated room and stored in an unheated one? Was the tire relocated from a warm climate to a cold climate? For more details on the effects of ambient temperature, see page 42.

- Use only an **approved calibrated gauge**, preferably of a dial or digital type. It is best to use the same gauge when monitoring a slow pressure loss in a tire/wheel assembly.

- **Foreign object damage** that penetrates the cord body and liner. Inspect the tire carefully for any FOD's.

- Check for **improperly seated beads**. This condition can be identified by comparing the position of the tire's lower sidewall annular rings, mold lines, or branding. Look to see if they are uniform from side to side or that they are above the wheel flange.

This condition can be caused by:

- Insufficient inflation pressure.
- Bead toes (bias tires only) not properly lubricated.
- Kinked or distorted beads.
- Accumulation of rubber on the bead flats.
- Dirt trapped between the tire and wheel.





● Leaks at the **valve stem or valve core.**

- Put a small amount of water on the end of the valve stem and watch for bubbles. If bubbles appear, replace the core and repeat the check.
- Valve caps, finger tightened, should be used to prevent dirt from entering and holding open the valve stem.

● Leaks at the **valve seal** (tubeless tires).

- Valve holes in the wheel must be free from scratches, gouges and foreign material.
- The proper O-Ring or grommet, as specified by the wheel manufacturer, must be used.

● **Wheel half parting line O-ring seal** (tubeless tires) leaks in service.

- Twisting or failure to lubricate the O-ring before installation may cause leakage at the wheel mating surfaces.
- Use of the wrong O-Ring compound, as specified by the

wheel manufacturer, suitable for the intended aircraft service (in particular low temperature service) may also cause leakage at the wheel mating surfaces.

- This type of leakage is very difficult to diagnose since the in-service conditions causing the leakage are not reproducible in a shop.

● Leakage through the **fuse plug** (tubeless tires).

- Use sealing gaskets specified by the wheel manufacturer, suitable for the intended aircraft service (in particular for low temperature service).
- A faulty fuse plug can allow a seepage of nitrogen and thus a loss of pressure.

● **Pressure release plug** (tubeless tires). Some wheel designs have a pressure release plug. The potential causes of leakage are the same as for a fuse plug.

● **Seepage between tire bead and wheel flange** (tubeless tires) can occur. An inspection should be made with particular attention to the following:

- Look for exposure of cord body in the bead toe area or bead flat area. Exposed cords may act as a wick for nitrogen to escape along.
- Foreign material trapped between the bead and wheel sealing surfaces causing a poor sealing between the tire and wheel.
- Gouges or scratches resulting from handling or improper use of tire irons. Damage can also occur along the wheel half mating surfaces and leakage may show in the O-ring seal area.
- Corrosion or wear in the bead ledge area (usually toe area of the tire bead) will leak at the tire-wheel contact area.

# Inflation

## pressure maintenance

	In all cases, be sure to account for:	For a Mounted Tire/Wheel Assembly, check for:	For a Dismounted Assembly, check tire and tube for:	For a Dismounted Assembly, check wheel for:
Initial Stretch Period (24 Hour Tire Growth)	X			
Changes In Air Temperature	X			
Venting of Tubeless Tires	X	X		
Release of Trapped Air in Tube-Type Tires	X	X		
Cut or Puncture		X	X	
Damaged Beads			X	
Improperly Seated Beads		X		
Leaking Valve core		X		
Other Valve Problems		X		X
Improper Installation of O-Rings				X
Faulty Thermal Fuse or Installation		X		X
Porous Wheels		X		X
Improperly Torqued Wheel Tie Bolts		X		
Wheel Gouges and Scratches		X		X
Corrosion or Wear on Bead Ledge Area				X
Knurls				X
Damaged Sealing Surfaces		X		X
Wheel Assembly Holes				X
Wheel Cracks		X		X

- A tube-type wheel converted to tubeless application should have the knurls removed. Leakage will show at the tire-wheel contact area.

### Troubleshooting - Have You Considered?

*The above pressure loss troubleshooting chart for tire/wheel assemblies will help you set up a uniform inspection procedure which can prevent problems and speed troubleshooting. Determine the status of your assembly in the columns above.*

#### Note:

- Tire inflation pressure must be at operating or rated pressure when testing for points of pressure loss.
- The point of leakage can be determined for the tire wheel assembly by applying a soap and water solution to the entire assembly or by immersing the tire/wheel assembly in water.

- **Leakage through the well area** of the wheel (tubeless tires) can occur from porosity or fatigue cracks, particularly if fatigue life is exceeded. Proper painting of the wheel should seal leakage from minor porosity.

- **Damaged Wheel Sealing Surfaces** or improperly machined sealing surfaces may cause slow leakage. Correct irregularities before assembling the wheel. Foreign material or heavy paint can impair the sealing surface.

- **Damage to the tire innerliner** (tubeless tires).

- Small **cracks or splits** in the inner tube.

# *Serviceability criteria*

## **Tire serviceability criteria**



# Tire serviceability criteria

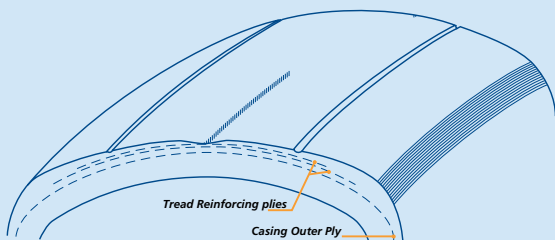

Wear Removal Criteria for Retreadable Bias Tire

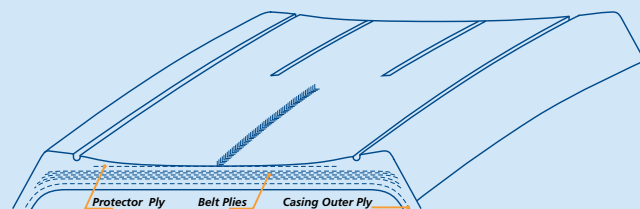

Wear Removal Criteria for Retreadable Radial Tire

A simple, easy-to-perform series of inspection procedures can prevent minor incidents from developing into major problems and help to optimize tire performance. Regular inspection is a small price to pay to protect your valuable tires, and the safety of your aircraft and the people it carries.

**Note:** If an aircraft has made an emergency or particularly rough landing, the tire, tube and wheel should always be checked.

## On-aircraft inspection with tire mounted

### Removal Criteria - Wear

The tread area of the tire should be visually inspected for any damage and the state of tread wear. Removal at the right time will optimize tire wear, while still protecting the life and investment of the carcass.

In the absence of specific instructions from the Airframer (Operations Manual, Service Bulletins, etc.), a tire should

be removed from service for wear using the following criteria:

Based on the fastest wearing location, remove tires:

- When the wear level reaches the bottom of any groove along more than 1/8 of the circumference on any part of the tread,

or

- If either the protector ply (radial) or the reinforcing ply (bias) is exposed for more than 1/8 of the circumference at a given location.

**Note:** Tires reaching this wear point on an aircraft at a remote station can make a return-to-base flight(s) under standard operating conditions without sacrificing retreadability of the casing.

**Note:** In some military applications, the removal point of a tire is indicated by a red fabric cord built into the tire or a wear depth plug.

## Water can affect traction:

The accumulation of water on runway surfaces can affect wet traction. Its affect is dependent on a number of factors including water depth, aircraft speed and runway surface conditions. The most effective method to minimize the affects of water on traction is to reduce water depth or allow the water to escape from under the footprint more rapidly. Many airport authorities today have adopted "cross-grooving" for their runway surfaces which allows for rapid drainage of water.

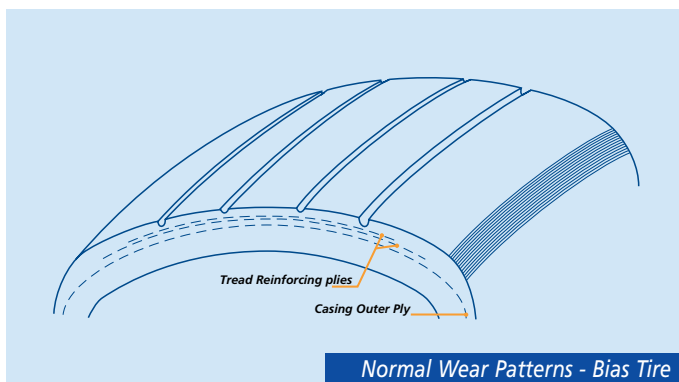

Normal Wear Patterns - Bias Tire

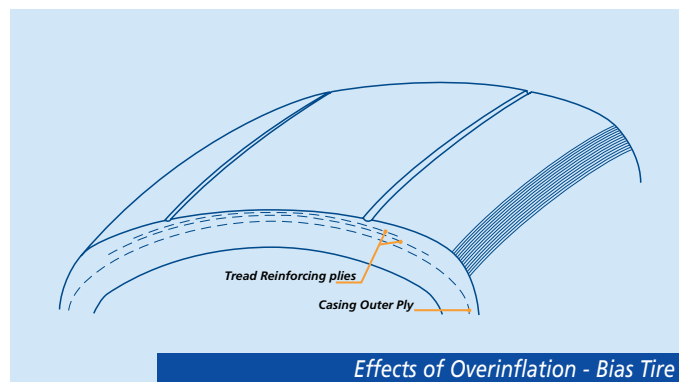

Effects of Overinflation - Bias Tire

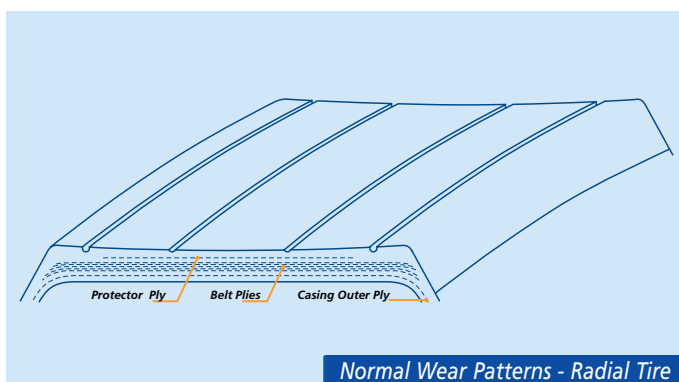

Normal Wear Patterns - Radial Tire

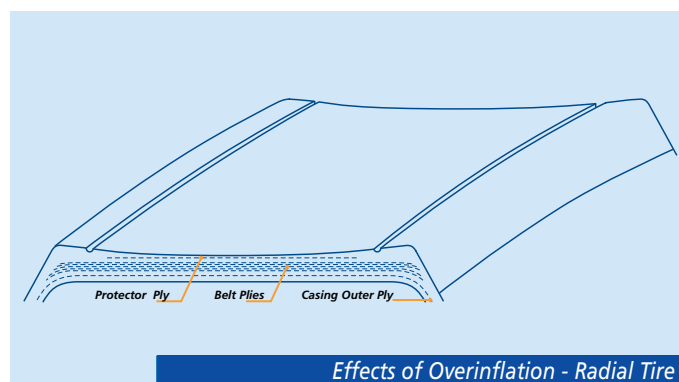

Effects of Overinflation - Radial Tire

**Typical Wear Conditions:**

● **Normal wear**

When tire wear has been optimized from proper maintenance and inflation pressures, the first point of wearout will be near the centerline of the tire. Follow wear removal criteria.

● **Overinflation**

When a tire has been operated with a higher pressure than required for the aircraft loads, an accentuated centerline wear will be apparent. Overinflation has reduced the number of cycles to wearout and made the tire more susceptible to bruises, cutting and shock damage. Follow wear removal criteria.



# Tire serviceability criteria

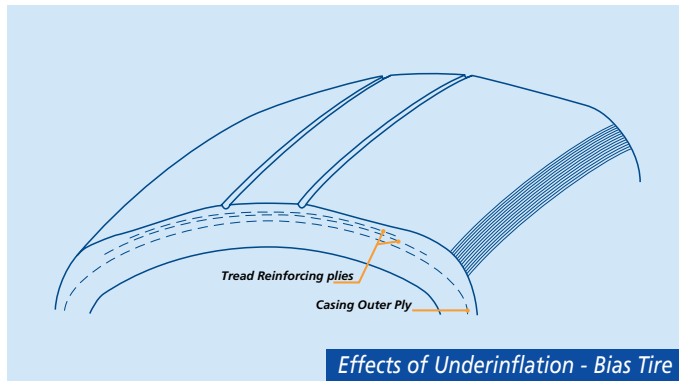

Effects of Underinflation - Bias Tire

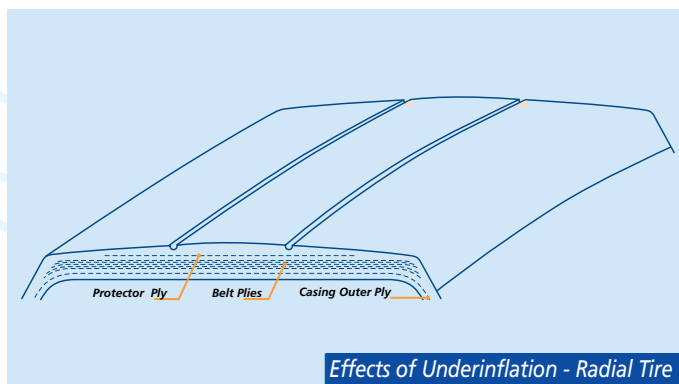

Effects of Underinflation - Radial Tire

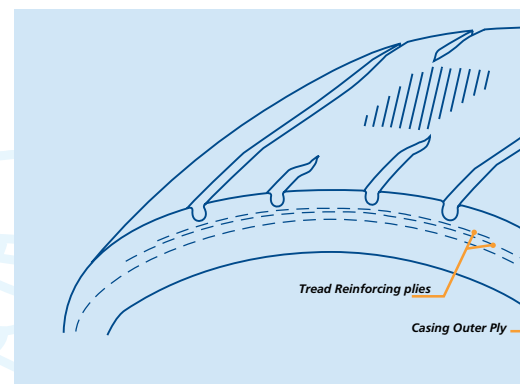
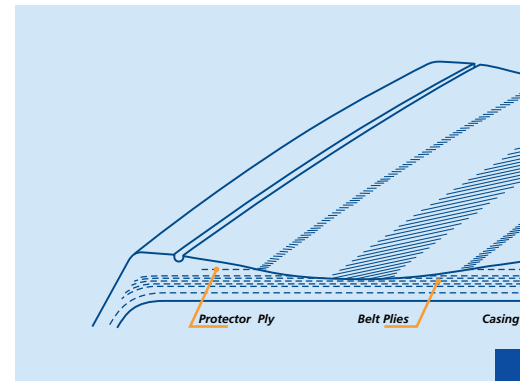

## ● Underinflation

When a tire has consistently been operated underinflated, shoulder wear will result. Severe underinflation may cause ply separations and carcass heat build-up which can lead to thrown treads, sidewall fatigue and shorten tire life. Follow wear removal criteria.

## ● Worn Beyond Recommended Limits

Tire has been worn beyond acceptable limits and into the top belt plies (top carcass plies for bias - not shown). Tire is not retreadable.

## ● Flat Spotting

This tire wear condition is a result of the tire skidding without rotating, i.e., brake lockup or large steer angle.

- Tire should be removed from service if the flat spotting exposes the protector ply (radial tire) or reinforcing ply (bias tire).
- If flat spotting does not extend to the protector ply or reinforcing ply, the tire can be left in service.
- If the localized loss of rubber results in aircraft vibrations, even though no fabric has been exposed, the tire must be removed from service.

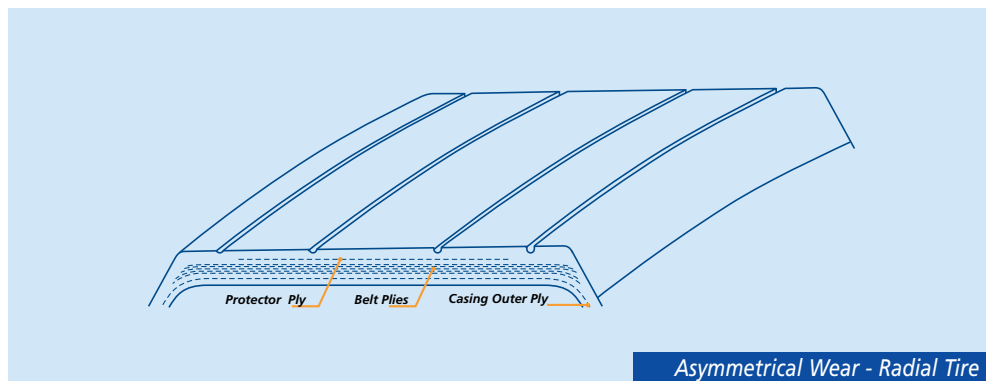
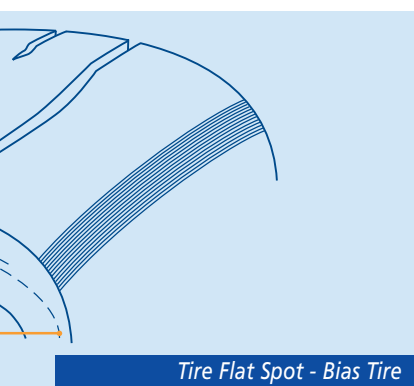
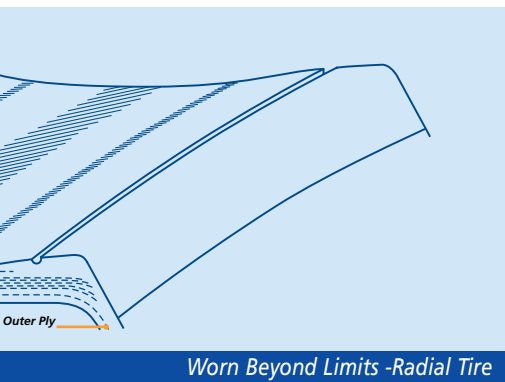

### ● Asymmetrical Wear

The tire has been operated under prolonged yaw and/or camber. This camber angle can be induced through landing gear or undercarriage deformation or manufacturer's settings/tolerances. Taxiing with one engine or high speed cornering can also cause asymmetrical wear.

In some cases, low inflation pressure will contribute to this condition. Tires that do not expose any fabric can be dismantled, turned around and remounted to even up wear. As long as standard wear criteria is met, the tire should remain in service.

# Tire serviceability criteria

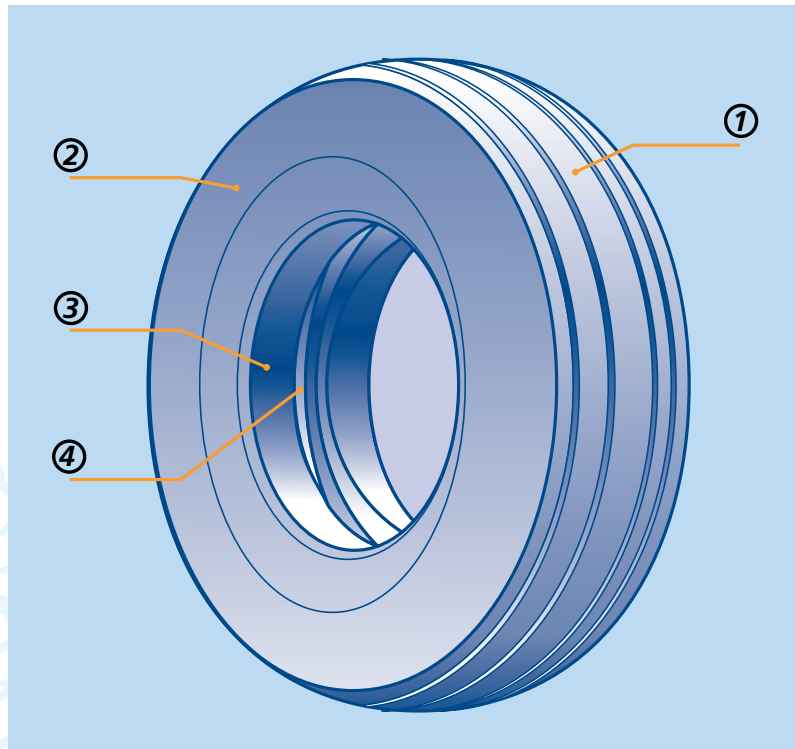

*Suggested approach:*  
1. Tread  
2. Sidewalls  
3. Bead areas  
4. Innerliner

## ● Serviceability Criteria/ Limits For Tire Damages

When assessing tire damages, it is best to make inspections with the tire inflated. Many damages that are readily visible on an inflated tire can no longer be seen when that tire is uninflated.

Be sure to mark all damages with a chalk stick before dismounting the tire.

Tires removed should be tagged with a "Reason For Removal."

**A Systematic Approach to Tire Inspection** assures that all parts of the tire are properly inspected. A recommended sequence of inspection is given above:

## ● Tread wear

\* Check for typical wear patterns. Follow removal guidelines given under the section "Removal Criteria - Wear."



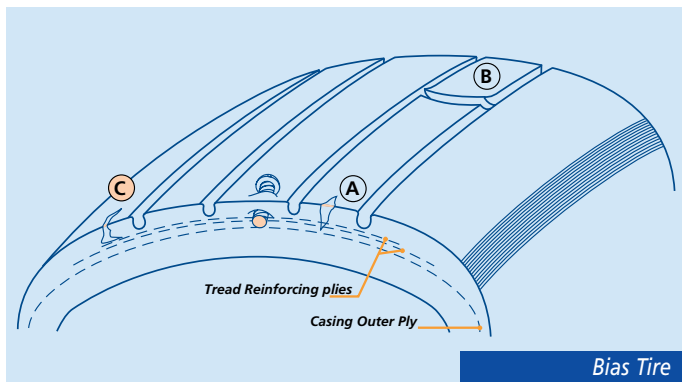

Bias Tire

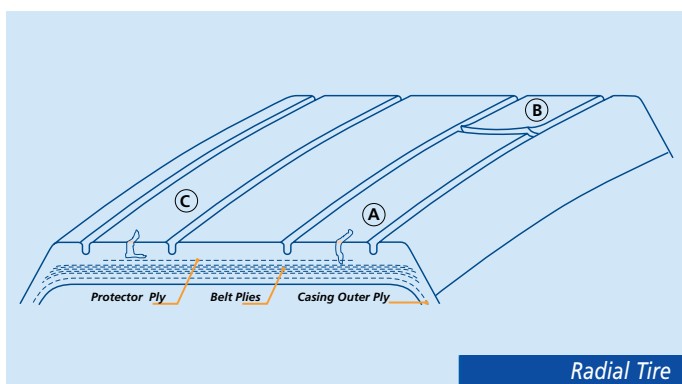

Radial Tire

**Tread Cuts**  
Remove tire from service when:

- A. Depth of cut exposes the casing outer ply (bias) or outer belt layer (radial).
- B. A tread rib has been severed.
- C. Undercutting occurs at the base of any cut.



Embedded objects take all forms

● **Tread Cuts/Foreign Objects**

Tread cut removal limits are at times given in specific documentation such as aircraft maintenance manuals, T.O.4T-1-3, technical documentation, airline operation manuals, tire sidewall markings, etc. Follow specific guidelines when given.

In the **absence of specific cut removal documentation**, tires should be removed when:

- Cuts, embedded objects or other injuries expose or penetrate the casing cord body (bias) or tread belt layers (radial).
- If a cut or injury severs or extends across a tread rib, the tire should be removed from service.
- Under cutting at the base of any tread rib cut is cause for removal.  
Round foreign object openings are acceptable up to 9.5 mm/0.375" in diameter.

**Note:** Tires removed for tread cuts or other injuries should be sent to a certified repair station to be repaired and retreaded or scrapped.



# Tire serviceability criteria

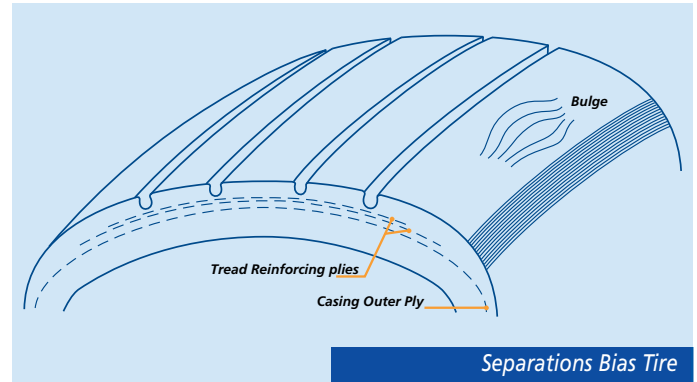

Mark all cuts, foreign objects, damages or leaks while tire is inflated. Use a light colored crayon, wax marker or paint stick. Damages can be difficult to find when a tire is uninflated.

**Caution: Do not probe objects while tire is inflated.**

**Bulges or separations**  
Immediately remove the tire from service. Mark these areas with a color crayon before deflating.



Chevron Cutting not exposing textile can be left in service

**Chevron Cutting:**  
Remove tire from aircraft if:

- Cutting causes the tread to loosen or chunk exposing the tread reinforcing ply or protector ply more than  $6 \text{ cm}^2 / 1 \text{ in}^2$

**Continue in service if:**

- Cutting penetrates the tread to a level less than one-half the molded skid depth even if the surface exhibits some shallow chipping or chunking.

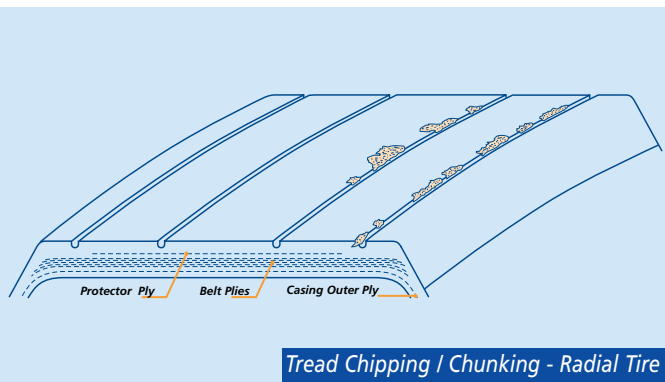

Tread Chipping / Chunking - Radial Tire

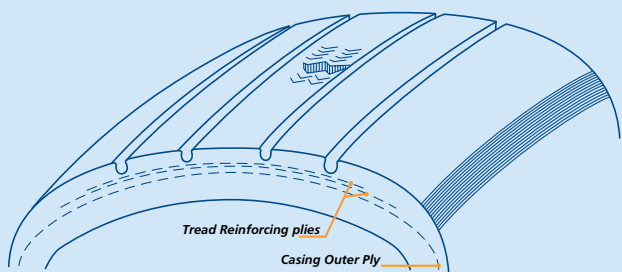

Chevron Cutting - Bias Tire

**Chevron Cutting**

Remove from service if the chevron cutting results in chunking which extends to and exposes the reinforcing or protector ply more than  $6 \text{ cm}^2 / 1.0 \text{ sq. in.}$

**Tread Chipping/Chunking**

Remove from service if the reinforcing ply (bias) or protector ply (radial) is exposed for more than  $6 \text{ cm}^2 / 1.0 \text{ sq. in.}$



# Tire serviceability criteria

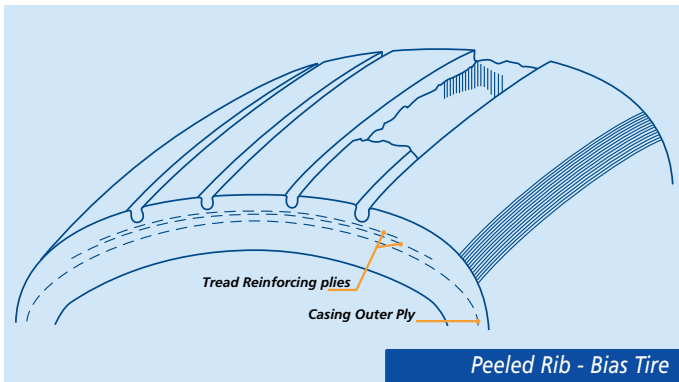

Peeled Rib - Bias Tire

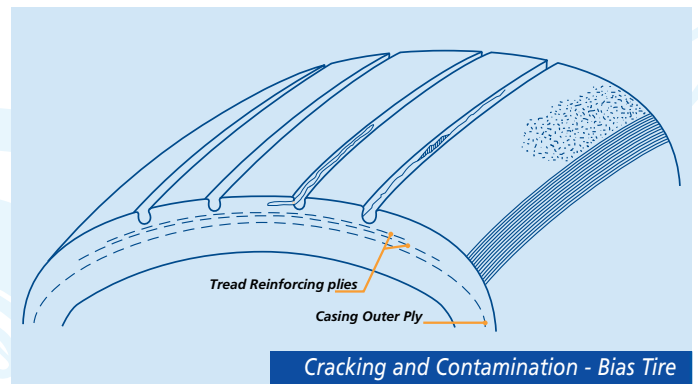

Cracking and Contamination - Bias Tire

## Peeled Rib

Remove from service if the reinforcing ply (bias) or protector ply (radial) is exposed.

## Groove Cracking

Remove from service if the groove cracking exposes the reinforcing ply or the protector ply for more than 6 mm / 1/4" in length.

**Note:** Authorization is given to return to maintenance base (<6 flights) to replace tires meeting the above criteria if there is no continuous cracking exposing textile greater than 25 mm / 1 inch in length.

## Rib Undercutting

Remove from service if undercutting extends more than 6 mm / 1/4" under the rib.

## Contamination

### From Hydrocarbons

Oil, grease, brake fluids, solvents, etc. can soften or deteriorate rubber components. Immediately upon contact with a hydrocarbon substance, wash the contaminated area first with denatured alcohol, then with a soap and water solution. By pressing the rubber surface in the contaminated area versus the adjoining uncontaminated area, determine whether the rubber has become softened or "spongy". If so, remove the tire from service.

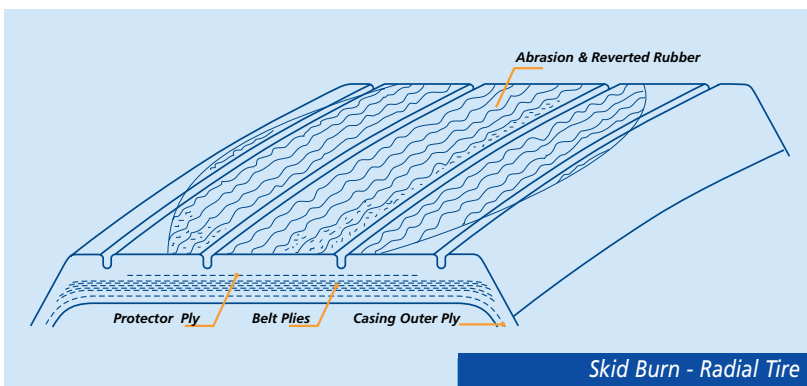

Skid Burn - Radial Tire

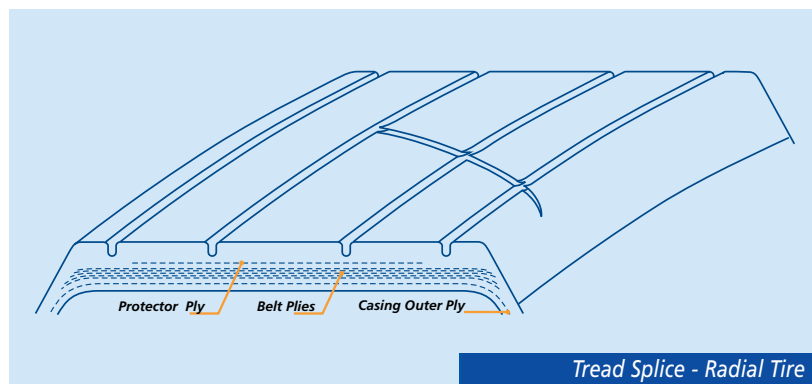

Tread Splice - Radial Tire

**Skid Burns from Hydroplaning**

This condition occurs on wet or ice-covered runways. Remove from service if the reinforcing ply or the protector ply is exposed.

**or**

if the severity of any flat spot is such that aircraft vibration is unacceptable to operational crews.

Rubber reversion visible on the surface does not affect the performance capability of the underlying tread rubber and should not be the determining factor for removal.

**Open Tread Splice**

Remove from service if apparent.



# Tire serviceability criteria

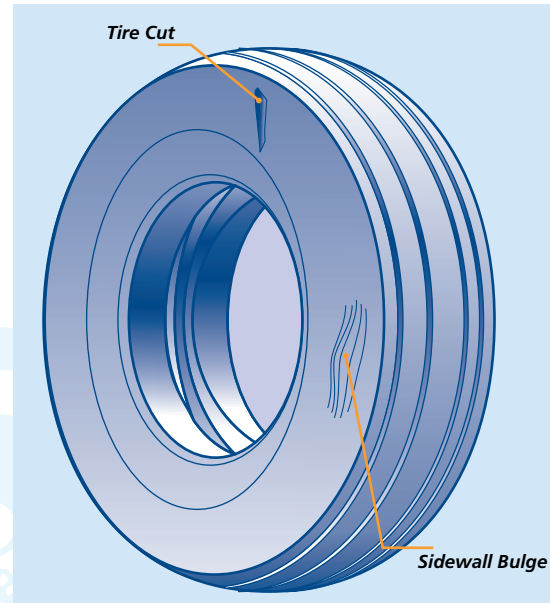
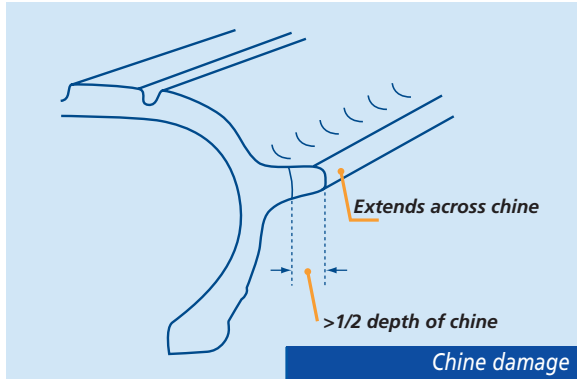

## ● Sidewall Cuts/Foreign Objects Cuts, Snags, Gouges or Other Injuries

Mark all damaged areas with a light colored crayon, wax marker or paint stick while the tire is inflated. Such injuries can be difficult to find when the tire is uninflated.

**Caution: Do not probe cuts while tire is inflated.**

- **If sidewall cords are exposed or damaged, remove the tire from service.**
- **Cuts in the rubber which do not reach the cord plies are not detrimental to tire performance. The tire can be left in service.**
- **Chine tires: Any cut that severs or extends across the chine and is more than 1/2 the depth of the chine should be removed.**

## Sidewall Bulge/Blister/ Separation

If any are found, the tire should be removed from service immediately.

### Sidewall Cut or Crack

- If condition is within the sidewall rubber, continue in service.
- If sidewall cords are exposed or damaged, remove the tire from service.

### Bulge / Blister / Separation

Remove the tire from service.

## Weather / Ozone Cracking

Remove from service only if weather or ozone checking or cracking extends to the cords.

**Important: Weather checking or cracks that do not reach the carcass cords are not detrimental to tire performance and do not constitute cause for removal. Tires showing only surface cracking can be left in service.**



## Serviceability Criteria / Operational Conditions:

### ● Hard Landing

After a particularly hard landing, tires, wheels, brakes and landing gear systems should be visually inspected for damage.

Inspect the tires for any obvious signs of damage such as cuts, splits in the rubber, flat spotting, tread chunking, bulges, etc. For damages, follow the guidelines given under *Serviceability Criteria / Limits For Tire Damages*.

If no damages are noted, the tire(s) should be left in service.

It is recommended that an entry of the landing be made in the aircraft log as a future reference. Some tire damages, such as bottoming the tire, may not become apparent until several landings later.

### ● Rejected Take off

Aircraft experience various levels of rejected takeoffs. Not all rejected takeoffs are severe enough to warrant automatic tire removal. The following guidelines are recommended:

- Where aircraft speed remains below normal landing speeds and normal braking energies are experienced, tires may be left in service. A visual inspection should be made on each tire to assure all tires meet the serviceability criteria. Pay particular attention to any tire flat spotting that may have occurred as a result of braking. A minimum 30 minute tire / brake cooling period is required prior to the continuation of the aircraft's flight schedule.

- Where aircraft speeds exceed normal landing speeds and high braking energies are experienced, tires should be removed from service, labeled as an RTO tire and returned to the retreader for inspection and disposition.

# Tire serviceability criteria



## Off-Aircraft Inspection With Tire Dismounted

### A Systematic Approach to Tire Inspection

A systematic approach to tire inspection is recommended to insure that all areas are properly inspected. The following system is recommended.

Inspect the **Tread Area**. Follow the procedures given for On-Aircraft Inspections.

After the tread area, inspect **Both Sidewall Areas**. Follow the procedures given for On-Aircraft Inspections.

Inspect the **Bead Areas**.

- Check the entire bead area from just above the heel of the bead to the innerliner for chafing from the wheel flange or damage from tire tools.

#### ● For **Bias Tires**:

- An exposed chafer strip on the bead face will normally cause no trouble and such a tire is fit for service and can be retreaded.
- Damage, blisters or separations of the chafer strips are repairable. Send the tire to an authorized repair station.
- *If carcass cords under chafer strip are damaged, the tire should be discarded.*

#### ● For **Radial Tires**:

- If bead area wear, along the wheel flange, exceeds 1 mm/1/32", remove the tire from service.
- If protruding bead wires, bead wire separations, or badly kinked beads are found, the tire should be discarded.

Inspect the **Tire's Innerliner**.

- As with external areas, any tire with loose, frayed or broken cords inside should be discarded.
- Liner blisters, especially in tubeless tires, should be left undisturbed. Do not pierce, puncture or cut them. To do so will destroy the air-retaining ability of a tubeless tire.
- Generally, confirm the good condition of the innerliner (e.g., no wrinkles).

**Tube Inspection.**

- When inspecting tubes, do not inflate them with more pressure than is required to simply round out the inner circumference of the tube (never more than 1 psi).
- Carefully inspect the inflated tube for leaks. First visually and then by submersion in water.





- Examine the valve stem for leaks, signs of valve pad separation and bent or damaged valve stems.
- Inspect the tube for severe wrinkles or creases. Remove from service if any are found. Wrinkles are evidence of improper fitting of the tube within the tire. Where wrinkles exist, chafing takes place, and that can result in loss of air or a blowout.
- Inspect tubes for evidence of chafing by the toes of the tire beads. If chafing exists, remove the tube from service and scrap.
- Examine for thinning. Where the heat is greatest, the tube has a tendency to be stretched over the rounded edge of the bead-seat of the wheel. This is one of the reasons why, when mounting, tubes should always be inflated until the tire beads are in position, then completely deflated and reinflated to the final pressure.

The stretch on the tube is then equalized throughout its inner and outer periphery.

Also check tubes for possible thinning out due to brake drum heat in the area where they contact the wheel and bead toes. The “set” or shape of the tube will help to determine when it should be removed from service because of thinning in the bead areas. Feeling the tube with the fingers will also reveal thinned areas.

On wheels with only one brake drum, this heat-set condition will normally show up only on one side of the tube. In those cases where the brake drum is a considerable distance from the rim, it is unlikely that this condition will ever be experienced.

#### **Inspect For Wheel Damage.**

- Wheels should be inspected following the wheel manufacturer’s recommendations.
- In general, make a visual inspection of the entire wheel. Wheels that are cracked or damaged should be immediately taken out of service for further checking, repair or replacement.
- If used, check the condition of the thermal fuse plug or overinflation plug. Melted, pushed out or leaking plugs should be replaced. Be sure that sealing gaskets are the ones specified by the wheel manufacturer for the service conditions of the aircraft. Gaskets should be free from distortion and damage. If a fuse plug blows while the tire is rolling, the tire and its axlemate should be scrapped because both tire will have been subjected to overload conditions.

# *Matching / Mixability*

## **Matching and mixability of dual tires**

66

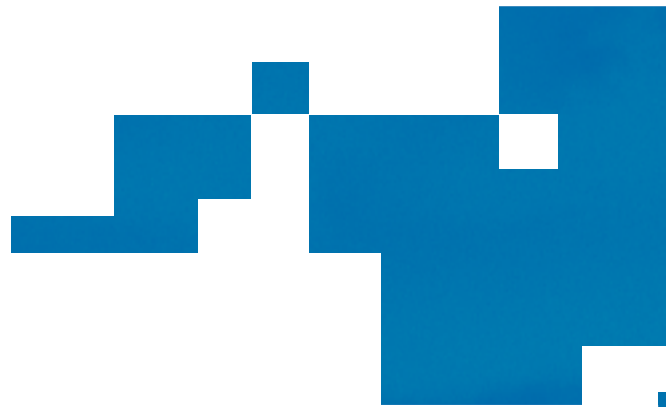



## Matching Tires

*In applications involving dual wheels or dual wheels on a multi-wheel landing gear configuration, tires should be **matched in diameter or static loaded radius** within the appropriate association's (T&RA, ETRTO, MIL-T-5041, AIR 8505A, etc.) inflated dimensions for both new and grown tires. It is important to ensure equal distribution of aircraft load on all tires and to avoid over-loading a tire beyond its limits.*

## Matching Criteria

Matching tires assures that the sizing of the tires is such that both tires will carry, within industry standards, equal loads.

### ● Bias tires:

- Same Size
- Same Type
- Within the **Overall Diameter** limits as recommended by the governing association for the particular application (civil, military).

### ● Radial tires:

- Same Size
- Same Type
- Within the same **Static Loaded Radius** limits:

- For Civil application Radial tires, use grown dimensions.

#### REFERENCES:

- "Tire and Rim Association inflated dimensions."
- "Michelin Aircraft Tire Engineering Databook."

- For military application Radial tires, use inflated dimensions.

#### REFERENCE:

- "Michelin Aircraft Tire Engineering Databook."

### ● New versus Retreaded tires

The practice of mounting both new and retreaded tires on the same axle is acceptable. Follow the same guidelines as above.

## Mixability

The mixability of aircraft tires has become an important issue in recent years. It is Michelin's position that the ultimate authority for approving mixability of different tires on an aircraft lies with the aircraft manufacturer or aircraft design authority who alone has full knowledge of all aircraft performance requirements.

A key point for mixability is that matched tires carry the same load at the same pressure. Three possible configurations of tires exist. The following guidelines are given for mixability:

### ● Bias - Bias

- Bias tires can be mixed on the same axle or bogie if the following requirements are met:
  - The tires are of the same size designation.
  - All tires are qualified for the aircraft application.
  - All tires meet the type designation and overall

# Matching and mixability of dual tires

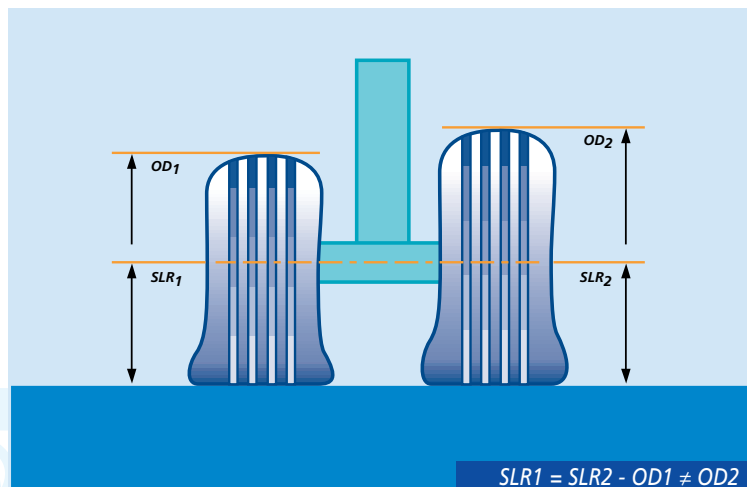

diameter size standard established by either:

- *The Tire and Rim Association*
- or
- *The European Tyre and Rim Technical Organization*

## ● Radial - Radial

- Radial tires can be mixed on the same axle or bogie if the following requirements are met:
  - The tires are of the same size designation.
  - All tires are qualified for the aircraft application.
  - All tires meet the size standards for overall diameter and static loaded radius established by either:
    - *The Tire and Rim Association*
    - or
    - *The European Tyre and Rim Technical Organization.*

## ● Bias - Radial

- No specific rule can be applied for this case. The mixability of bias and radial tires is determined by the airframer through

aircraft testing. In all cases, airframer and airworthiness authorities recommendations must be followed.

Three possibilities exist:

- 1** Bias tires on the nose gear and Radial tires on the main gear or vice versa.
  - No effect on tire or aircraft performance unless otherwise specified by the airframer.
- 2** Mixing on a gear made up of bogies and dual mounts.
  - Any proposed mixing must be approved by the airframer.
  - Radial and Bias tires approved for the same application may be of different overall diameters when stood side by side. It is important that the static loaded radius of the two tires be the same (see figure above). Contact the airframe manufacturer or tire manufacturer for static

loaded radius information.

- Radial tires approved for application on the same axle or bogie of an aircraft will operate at the same inflation pressure.
- 3** Bias tires on one main landing gear bogie and Radial tires on the other.
  - Any proposed mixing must be approved by the airframer.
  - Radial and Bias tires approved for the same application may be of different overall diameters when stood side by side. It is important that the static loaded radius of the two tires be the same.
  - Radial tires approved for application on the same aircraft but different axles or bogies may operate at different inflation pressures than the Bias tire. This is mostly true of high performance military applications.



## Observe Load and Inflation Recommendations

When operating tires in combination, it is important to respect load and inflation recommendations.

There is a limit to the load any aircraft tire can safely carry. The maximum static load limits, as recommended by the Tire and Rim Association and/or the European Tyre and Rim Technical Organization, are shown in the Load and Inflation Tables in the document entitled Michelin Aircraft Tire Engineering Data. Similar information is also contained in the T&RA Yearbook and ETRTO Data Book.

Overloading a tire puts undue strain on the cord body and beads of the tire, reducing its safety factor and service life. It further increases the chance of bruising, impact and flex breaks in the sidewall or shoulder areas of the tire, particularly under landing stress

or in the event the tire strikes an obstruction. It can cause potential wheel damage. Under the severe strain of an extra load, the wheel may fail even before the tire does.

It is important to use inflation pressures recommended by the airframe manufacturer for each tire. Be sure to determine if loaded or unloaded inflation pressure is specified. Loaded inflation pressure will be 4% greater than unloaded inflation pressure.

If tires are run at unequal pressures, the tire with the higher inflation pressure will carry a greater share of the load even though both tires will be of the same deflection. This higher shared load can reduce the safety factor and service life of the tire.

Tire pressures should be checked daily with an accurate gauge when the aircraft is engaged in more than one flight a day. Otherwise, pressures should be checked before each flight.

***WARNING! Aircraft tires can be operated up to or at rated inflation pressure. Extremely high inflation pressures may cause the aircraft wheel or tire to explode or burst, which may result in serious or fatal bodily injury. Aircraft tires must always be inflated with a properly regulated inflation bottle or canister. The high pressure side should never be used. The safety practices for mounting and dismounting aircraft tires detailed in this Manual must be followed.***



# *Vibration / Balance*

## **Vibration and balance**

70





*Certain aircraft have nose landing gears which are sensitive to vibration. For these cases, assemblies should be checked for balance and wheel weights added when required.*

*Vibration, shimmy and other similar conditions are usually blamed on improper tire balance. Imbalance is a well known and easily understood cause for vibration. In many cases though, this may not be the cause. There are a number of specific aspects of the tire, wheel and gear assembly which can be the cause or contribute to aircraft vibration. As with any concern, a systematic approach should be taken to isolating its cause.*

- **Check** that the tire has been inflated to the **proper inflation pressure**.
  - Follow the airframer's recommendation.
  - Be sure an accurate calibrated pressure gauge has been used.
- **Check** that dual tire **inflation is equalized** between tires and per the operating specification.
- **Assure** that the tire reached **full growth** before it was installed on the aircraft.
  - Allow at least 12 hours at operating or rated pressure for the tire to attain full growth.

- **Check** that the **beads** of the tire have been **properly seated**.
- **Check** the tire for **flat spotting** or **uneven wear**.
  - If flat spotting does not extend to the protector ply (Radial) or reinforcing ply (Bias) and vibration is acceptable, the tire can be left in service.
- **Verify** that tires have been **properly mounted**.
  - For tubeless tires, the red balance mark on the lower sidewall of the tire should be aligned with the wheel valve.
  - For tube-type tires, the balance mark (light spot) on the lower sidewall of the tire should be aligned with the balance mark (heavy spot) on the tube.
- **Check** for **air trapped** between the tire and tube.
  - Use a soapy solution to check for leakage at the base of the tube valve stem where it exits the wheel.
  - Rolling the tire by taxiing will

generally work any trapped air out from between the tube and tire.

- **Is the tube wrinkled** because of improper inflation procedures?
- **Is the wheel out of balance** because of improper assembly?
  - Follow the wheel manufacturer's instructions for properly aligning wheel halves.
  - The balance mark on the tire should be aligned with the valve mounted on the wheel, unless otherwise specified by the wheel manufacturer.
- **Check** the **condition of the wheel** to see if it has been bent.
- **Check** for a **loose wheel bearing** caused by an improperly torqued axle nut.
- **Check** for poor **gear alignment** as evidenced by uneven wear.
- **Check** for **worn** or loose landing **gear components**.

# *Dismounting*

## **General dismounting instructions for aircraft tires**





**AIRCRAFT TIRE EARLY REMOVAL TAG**

A/C \_\_\_\_\_ POSITION \_\_\_\_\_ Date \_\_\_\_\_

**REASON FOR EARLY REMOVAL**

Cut/FOD	Bulge/Deformed	Low Pressure ( _____ psi)
Cracking	Vibration	Flat Tire
	Blown Fuse Plug	Mate-to-Flat

OTHER \_\_\_\_\_

(Circle one (1) Reason) Form # AIRT0708

## Removal from landing gear

*Deflate any non-serviceable, damaged tire/wheel assembly before dismounting from the aircraft. Worn, serviceable units may be left inflated.*

## Reason for removal - Tracking

*In order to properly track reasons for tire removal and to take appropriate action, it is very important to have accurate information regarding tire removal. This information helps the retreader or repair station to make decisions concerning inspections and the future use of the tire.*

## Recommended information includes:

- Name of Operator
- Date of dismounting
- Aircraft model tail number
- Tire part number
- Tire serial number
- Reason for removal
- Number of tire landings

It is further recommended that removal information **accompany the tire** to the repair station or retreader. The simplest approach is to use a **tag or label** attached to the tire with a self sticking adhesive (applied to lower sidewall) or by use of heavy or nylon string.

**Caution: Do not use staples or other metal devices for affixing tags or labels to tires or inner tubes. Keep adhesive labels above the bead area of the tire.**

*A sample label is shown above.*

## Tire dismounting

Proper dismounting procedures simplify the job of servicing aircraft tires, while increasing safety and reducing the chances of damaging tires or wheels. The task of dismounting tires should not be undertaken without proper equipment, instructions and trained personnel.

Careful attention must be given to disassembling and handling wheel components to avoid damage to critical surfaces. To assist in this process, wheel manufacturers publish specific instructions in their maintenance and overhaul manuals. Follow their recommendations and procedures to assure trouble-free dismounting.

# General dismounting instructions for aircraft tires

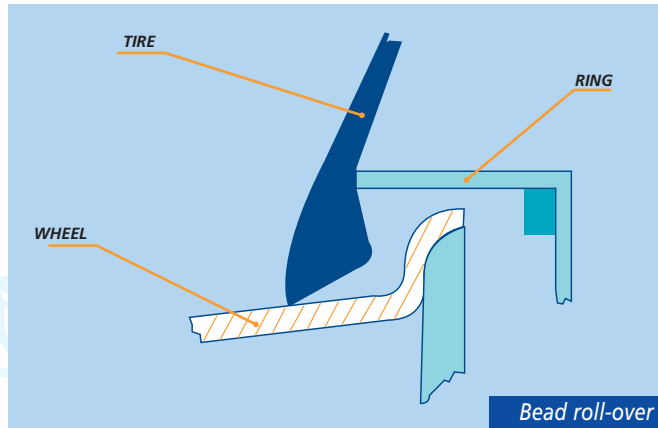

## Tire/Wheel Dismounting Sequence

*The same methods are essentially used for dismounting tubeless bias, tube-type bias and radial aircraft tires. However, radial tires have a smaller bead flat area and have a more flexible sidewall, which requires that more attention be placed on the tooling set-up. Failure to use proper tooling designed for the particular tire size could result in dismounting difficulties. Follow the tooling guidelines given in the next section.*

Once tooling has been set-up, dismounting should occur in a similar manner for both bias and radial tires, tubeless and tube-type.

- Before beginning any tire dismount, be sure to **follow the instructions and precautions published** in the wheel supplier's maintenance manual.
- Mark damaged or bulge areas before deflating, using a contrasting color chalk.

- Completely deflate the tire or tube before dismounting.
- Use **caution** when unscrewing valve cores. The pressure within the tire or tube can cause a valve core to be ejected at high speed.
- If damage has occurred, a tire/wheel assembly should be deflated in a protective cage.
- Use a bead breaker to loosen tire beads from both wheel-half flanges.
- Always use proper bead breaking equipment designed for separating tires from wheel bead seats. Do not use pry bars, tire irons, or any other sharp tools to loosen tire beads. Damage to the tire and wheel may occur.
- Do not loosen wheel tie bolts prior to breaking the beads loose. Damage to the mating surfaces of the wheel halves can occur.
- Ensure that the adaptor **rings** of the ring type bead **breaker have passed over the wheel flanges** and do not interfere with any wheel components.
- Ensure the faces of the adaptor rings or press pads, in contact with the tire, are free of nicks, burrs or sharp edges which could damage the tire surfaces.
- **Apply bead breaker ram pressure or arm pressure slowly or in a series of sequences or jogs** to allow time for the tire's beads to slide on the wheel.
- Because of the flexible sidewalls of a radial, use of incorrect tooling or applying pressure too rapidly can cause sidewall distortion. Heavy distortion of the sidewall is not only harmful to the internal tire components, but it may also begin to "roll" the beads, making dismounting more difficult.

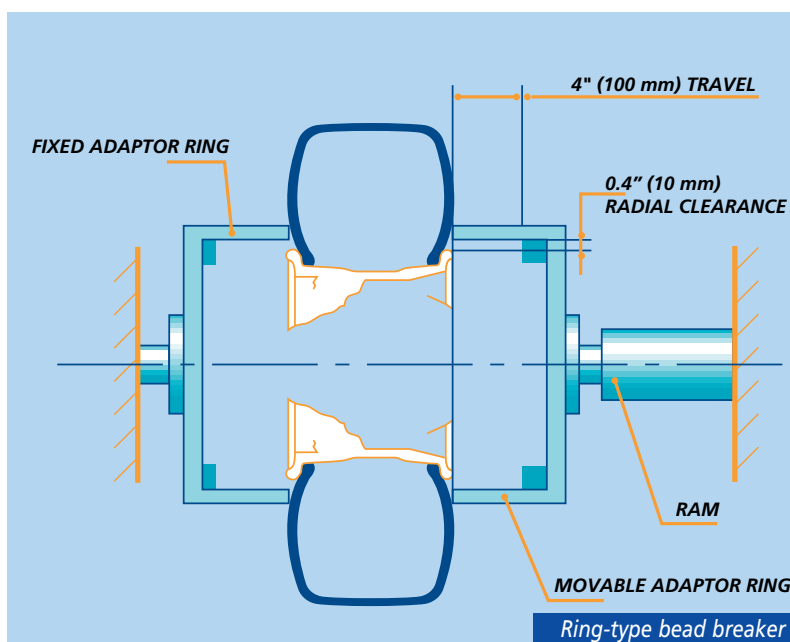

### ● What To Do If The Tire Becomes Fixed To The Wheel

If a tire bead rolls such that it will no longer slide on the wheel:

- Release ram pressure. Apply a soap solution to the tire/wheel interface. Allow several minutes for the solution to penetrate between the tire and wheel.

**Note:** Do not use hydrocarbon-based lubricants. These can be harmful to the rubber components of the tire.

- Reapply a reduced hydraulic pressure to the tire.
- Repeat several times if necessary.

If the tire still remains fast:

- Remove the tire/wheel assembly from the machine.
- Reinflate the tire in a cage until the bead moves back to its correct position.
- Deflate the tire.
- Recommence the dismounting

procedure following the same procedure.

**Note:** Cases of bead roll over should be reported to the retreader who will examine the tire for damage. A tire found to have been damaged should be scrapped.

- Remove tie bolts and slide out both parts of the wheel from the tire.
- For tube-type tires, remove the tube.
- Tire is now dismounted.

### Tire Dismounting Equipment

*The primary component for dismounting an aircraft tire from its wheel is the bead breaking equipment used to loosen the tire from the wheel bead seats.*

Two types of bead breaking equipment can be identified here:

- The “ring” type bead breaker. Bead breaking is performed by pushing a movable adapter ring against the lower sidewall of one side of the tire. The opposite side consists of a stationary adapter ring that also contacts the lower sidewall of the tire.

*It is important that the “adapter” rings be designed for the particular tire/wheel assembly to be dismounted.*

The optimum condition is an adapter ring internal diameter as close to the wheel flange diameter as possible. Pushing too high on the tire sidewall will

# General dismounting instructions for aircraft tires

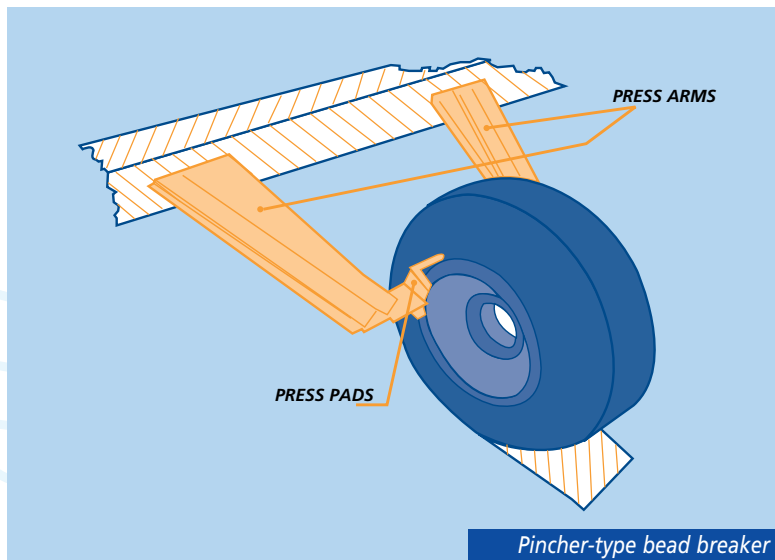

Pincher-type bead breaker

only distort the sidewall and bead area, making dismounting more difficult.

For practical purposes, a radial clearance between the tip of the wheel flange and the internal diameter of the adaptor ring is necessary to avoid interference between the wheel and adaptor ring as it approaches and travels over the wheel flange.

**Michelin recommends a radial clearance of 0.4 inches (10 mm).**

The movement (travel) of the adaptor ring should be at least four (4) inches (100 mm) to ensure complete separation of the tire from the wheel.

It is desirable that the rings be designed such that the tire can be observed while pressure is being applied, to ensure satisfactory ring contact and progress.

- Localized “pincher” type bead breaker.

This equipment consists of two press arms which can be operated in a “pincher” movement. At the end of each arm is a press pad in the form of a sector. An adjustable cylinder is used to position the tire so that the sectors can be matched to the size of the tire.

The tire/wheel assembly is positioned such that the press pads contact the tire’s lower sidewall just above the wheel flange.

Pressure is applied to break the beads. After the first sector of the tire begins to move away from the wheel flange, stop, rotate the tire/wheel assembly a short distance and repeat the operation until all sectors of the tire are loose and free from the wheel.

**Note:** When pressing against the tire, hold the pressure for 1-2 seconds to allow the bead time to move. Bead breaking is most efficient when the tire/wheel assembly is rotated approximately 30 degrees between each pressing operation.

The press pads used to push the tire are “universal” and are designed to push on the tire close to the wheel flange. No specific tooling is required for the different tire sizes to be handled.

# *Retread / Repair*

## **Retreading and repairing aircraft tires**



# Retreading and repairing aircraft tires



*Many aircraft tires that become injured in service can be successfully repaired. Tires of which the treads are worn out, flat spotted, or otherwise damaged, but of which the cord body is intact, can be retreaded. Retreading and repairing aircraft tires has been a common practice for many years and can save aircraft operators considerable sums of money. Tires that might otherwise have been discarded due to insufficient or damaged tread can be retreaded or repaired for continued service, at a cost much lower than that of a new tire. Retreading and repairing extends the service life of a carcass several times past initial new tire usage.*

*FAA/JAA Regulations require retreading and/or repairing of aircraft tires to be performed in certified retread and repair stations by or under the responsibility of qualified/certified technicians. Repairs by unauthorized sources are not recommended.*

*Michelin meets or exceeds all testing requirements of the FAA or JAA for retreaded aircraft tires.*

## Retreading Aircraft Tires

For aircraft tires, the term “retreading” refers to the methods of restoring a used retreadable tire by renewing the tread alone or by renewing the tread plus the reinforcing ply(s) or protector ply.

Full recapping is the recommended procedure for tires with evenly worn tread, tires with flat-spotted tread, or tires with numerous cuts in the tread area. The new tread material extends around and over the shoulder of the tire for several inches.

## Accepting Tires for Retreading

Accepting tires for retreading requires careful inspection of all components of the tire. Each individual tire is inspected by visual and air needle techniques prior to, during, and after the retreading process. Shearography inspection can also be used to inspect for internal defects which may limit the retreadability of a carcass.

Inspections must meet approved process limitations for that tire to be retreaded.

## Repairing Aircraft Tires

Many tires with injuries or damages can be repaired at the time of retreading and put back into useful/safe service. Injuries must be within the manufacturer’s repairable limits.

Tires with sidewall cuts, snags, scuffs and cracking from ozone can remain in service if the carcass ply is not exposed. Damages that expose carcass textile can be repaired by an approved repair station if the cords are not cut or damaged.

**Note:** Repairable limits generally exceed service-ability limits used to remove tires from service. Detailed, safe inspections suitable for determining the gravity of an injury cannot be made on inflated, mounted tires. Service removal limits are further set to ensure safe operation and retreadability of the casing.



## Non-repairable aircraft tires

The following list outlines some of the conditions which can disqualify a tire from being retreaded:

- Any injuries to the beads or in the bead area (except injuries limited to the bead cover or finishing strip).
- Weather checking or ozone cracking of tread or sidewall that results in exposed body cords.
- Protruding bead wire or kinked bead.
- Ply separation.
- Internal damage or broken cords.
- Flat spots and skid burns that have penetrated to the top carcass ply. Wearing the tire beyond the protector ply or reinforcing plies can leave insufficient interface rubber to allow retreading.
- Punctures that penetrate the innerliner.
- Excessive brake heat damage, such as that experienced in an aircraft rejected takeoff.
- Tires that are heavily oil soaked.
- Tires that have experienced a major pressure loss.

## Repairable aircraft tires

The following are acceptable when retreading aircraft tires:

- Tread Area  
The size of cuts and/or other tread injuries that can be repaired during retreading is dependent on many factors, including the injury's length, depth and width as related to the tire size itself. The number and size of a repairable injury is also dependent on the retreader's repair methods and validation. If specific details on repair limits are needed, see your Michelin retreader.
- Bead Area  
Minor injuries to the bead area may be repaired provided the carcass plies are not damaged.
- Innerliner  
Innerliner surface damage may be repaired (bias tires). The size of a repairable injury is dependent on the retreader's repair methods as well as government regulatory documentation.

- Sidewall Rubber  
Surface defects on large commercial tires may be repaired provided the repair is at least 1 inch from the bead heel, and no greater than an area 1 1/2 inches (50 mm) by 4 inches (100 mm), and does not penetrate or damage the carcass ply.

# *Operating tips*

## **Operating and handling tips for better tire service**

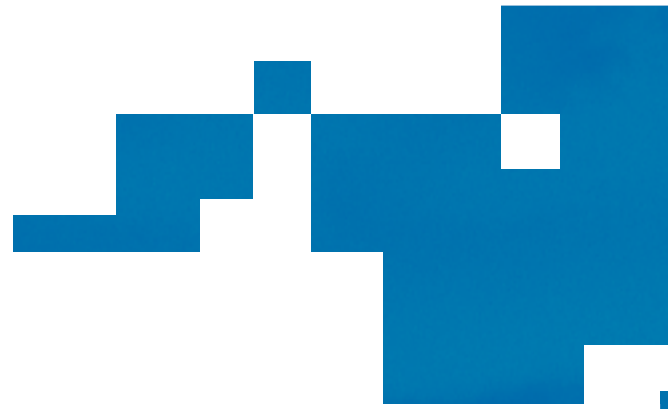





*Optimized tire performance is directly related to the use and care the tire is given. While the single most important action for obtaining optimum tire performance is a program of regular tire inflation maintenance, user (pilot) actions and the condition of the airport surfaces are also important. The following information is to help bring an awareness of these important factors which can further your tire investment.*

## Taxiing

Unnecessary tire damage and excessive wear can be prevented by proper handling of the aircraft during taxiing.

Most of the gross weight of any aircraft is borne by the main landing gear which may consist of two, four, eight, or more tires. The tires are designed and inflated to absorb the shock of landing and will normally deflect about three times more than a passenger car or truck tire. The greater deflection allows the tire to carry the heavy loads. It also causes more working of the tread, produces

a scuffing action along the outer edges of the tread and results in more rapid wear.

If an aircraft tire strikes a chuckhole, stone, or some foreign object lying on the runway, taxi strip or ramp, there is more possibility of it being cut, snagged or bruised because of the high operational deflection. If one of the main landing gear wheels, when making a turn, drops off the edge of the paved surface, this may result in severe sidewall or shoulder damage. The same type of damage may also occur when the tire rolls back up over the edge of the pavement.

With dual main landing gear wheels, it is important that they equally share the weight carried by that landing gear assembly.

As airports grow in size, and taxi runs become longer, chances for tire damage and wear increase. Internal tire heat buildup also can be of concern. Speed, length of rolling and stops are all important in

influencing heat buildup. A taxi speed of 40 mph for 35,000 feet is demonstrated during the TSO certification of a tire.

For either speeds or taxi distances greater than these limits, a 5-10 minute pause is recommended before takeoff.

For less foreign object damage in taxiing, all personnel should make sure that ramps, parking areas, taxi strips, runways and other paved surfaces are regularly cleaned and cleared of all objects that might cause tire damage.

## Pivoting By Using Brakes

Increased airport traffic and longer taxi runs are subjecting tires to more abrasion from turning and pivoting while braking.

Severe use of brakes under pivoting conditions can wear flat spots on tires and cause them to become out of balance, making premature retreading or replacement necessary. Pivoting on surfaces with heavy texture or a step condition can

# Operating and handling tips for better tire service



locally tear the tread from the casing. This tear may not show as a separation until later in the tire's service life.

Careful pivoting of an aircraft also helps prolong tire tread life. When an aircraft is turned by locking one wheel (or wheels), the tire is scrubbed, with great force, against the pavement. A small rock or debris that would ordinarily cause no damage can virtually be screwed into the tire. This scuffing and grinding action takes off tread rubber and places a very severe strain on the sidewalls and bead areas of the tire at the same time. Making wide radius turns will reduce tread rubber removal and sidewall stresses.

## Condition of Airport Field

Regardless of preventive maintenance and the care taken by pilot and ground crew, tire damage is almost certain to result if runways, taxi strips, ramps and other paved field areas are in bad condition, strewn with debris or poorly maintained.

Chuckholes, pavement cracks or step-offs in the pavement can all cause tire damage. In cold climates, especially during winter, all pavement breaks should be repaired immediately.

Accumulated debris on paved areas, including hangar floors, is especially hazardous. Stones and other foreign material should be kept swept off all paved areas. Special attention should be paid to make sure that tools, bolts, screws, rivets and other repair materials are not left lying on an aircraft so that when it is moved, they fall to the floor. If a tire rolls over such material it can result in punctures, cuts or complete failure of the tire and tube.

## Avoid Chemical Contamination

Chemicals and hydrocarbons such as jet fuel, hydraulic fluids, grease, cleaning agents, etc., can damage aircraft tires by softening or deteriorating the rubber surface. During aircraft maintenance, tires should be covered to protect them from accidental spills. Keep runway surfaces clean so that tires are not parked in surface puddles.

Immediately upon contact with a hydrocarbon substance, wash the contaminated area first with denatured alcohol then with a soap and water solution. If the rubber feels soft or spongy when probed, remove the tire from service.

## Nylon Flat Spotting

Nylon aircraft tires will develop flat spots under static load. The degree of this flat-spotting will vary according to:

- the temperature of the tire when the aircraft is first parked,
- the pressure in the tire,
- the load being applied to the tire while the aircraft is parked,
- the ambient temperature,
- the length of time the tire is subject to a combination of the above conditions,
- the type of construction (under similar conditions, a radial tire will develop less flat spotting than will a bias tire).

On a practical level, aircraft maintenance personnel cannot influence all of these variables.



To minimize the condition, inflation pressures should be kept at their specified operating levels and loads held to a minimum during the static load period.

Under normal conditions, a flat spot will disappear by the end of the taxi run. In the unusual case where deep flat-spotting has occurred, additional taxiing is recommended prior to take-off.

An aircraft that is to remain idle for a period longer than three days should either be moved every 72 hours or blocked up so that no weight is on the tires. Aircraft in storage (out of service for more than 14 days) should be blocked up so that there is no weight on the tires.

## Chevron Cutting

Cross-cutting of runways is common at many major airports around the world. It improves drainage, reduces the danger of standing water and thus, decreases the risk of hydroplaning. However, the sharp-edged ridges of concrete that result

can cause chevron-type cutting of the tire tread ribs, particularly on the high pressure tires used on jet aircraft.

Chevron cutting occurs during aircraft touchdown at “spin-up”. As the tire begins to accept aircraft loads, it deforms slightly in these cross-grooves. At the same time rapid acceleration is occurring. The forces required to accelerate the tire to ground speed cause a tearing action which forms the chevron.

These cuts are at right angles to the ribs and rarely penetrate to the fabric tread reinforcement ply or protector ply. Refer to the section on “Tire Serviceability Criteria” for handling this condition.

## Hydroplaning

This condition results when, on a wet runway, the tire’s tread is progressively lifted off the runway surface. A wave of water builds up in front of a rolling tire, allowing the tire to ride on the water and lose contact with the runway surface. Loss of traction, steering ability and braking action

occurs. This action is usually referred to as “dynamic hydroplaning.” Its occurrence is a function of water depth and aircraft speeds.

The same phenomenon can result when a thin film of water on the runway mixes with the contaminants present or if the surface texture of the runway is smooth. This is called “viscous hydroplaning.” Generally the irregular condition of the runway surface is sufficient to break up this film.

Today, most airport runways are designed to minimize water buildup. Cross-grooving is one example. In addition, tires have circumferential grooves which help to dissipate water.

An aircraft tire experiencing hydroplaning (usually viscous hydroplaning) may form an area of reverted rubber or skid burn in the tread. This area will be oval in shape similar to a flat spot. If the reinforcing ply or protector ply is not exposed, the tire can remain in service.

# Operating and handling tips for better tire service

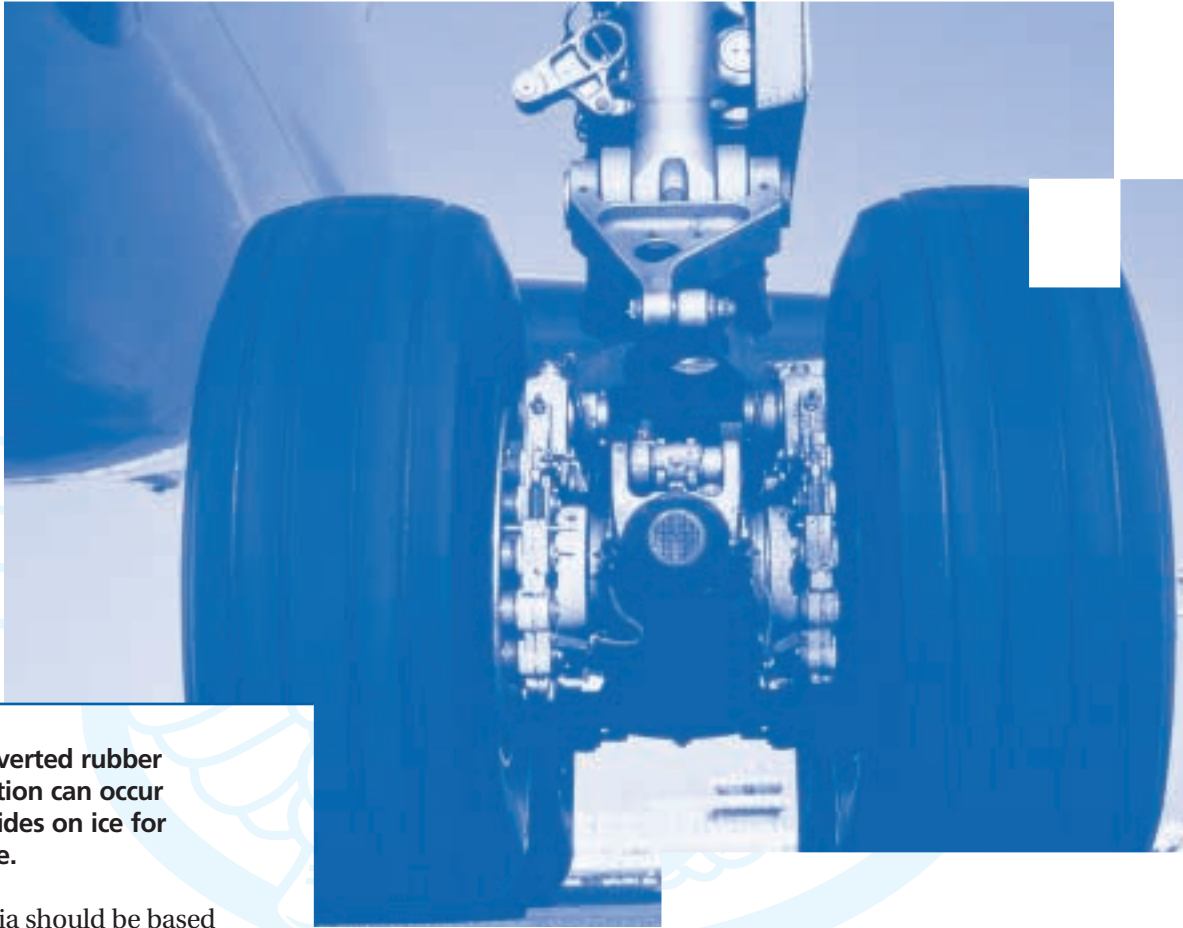

**Note:** A similar reverted rubber tread condition can occur if the tire slides on ice for any distance.

Tire removal criteria should be based on operational and tire condition factors. Factors to be considered are: runway cross-grooving, tire footprint area (number and remaining depth of grooves), and level of runway flooding. When operational and tire condition factors are conducive to hydroplaning, removal criteria should be adjusted accordingly.

Contact Michelin for detailed information.

## Landings per tread

Tire performance can be improved by using slow taxi speeds and by letting the aircraft roll during landing and by avoiding hard braking.

Whenever possible, make large radius turns which minimize tire scrubbing.



**Design:**

- Michelin Aircraft Product Line
- Studio graphique Michelin
- Gris souris

**Photos:**

- Air Bourget
- Boeing
- Gajic
- Mc Donnell Douglas
- Michelin
- Sirpa Air: Gauthier
- Trebosc

**Printing:**

- Imprimerie Fabrègue

### Headquarters

Michelin Aircraft Tyre  
23, place des Carmes-Déchaux  
63040 Clermont-Ferrand Cedex 9 - France  
Tel: 33 (0)4 73 32 76 40 - Fax: 33 (0)4 73 32 76 42

### Commercial Offices

**North, Central and South America :**  
Michelin Aircraft Tire Corporation  
1305 Perimeter Road  
Greenville, SC 29605 - United States  
Tel: 1 864 422 7000 - Fax: 1 864 422 7071

**Europe, Middle East and Africa:**  
Michelin Aircraft Tyre  
23, place des Carmes-Déchaux  
63040 Clermont-Ferrand Cedex 9 - France  
Tel: 33 (0)4 73 32 76 36 - Fax: 33 (0)4 73 32 76 44

**Far East and Oceania:**  
Michelin Aircraft Tyre Asia  
SPE Tower 12th Floor  
252 Phaholyothin Road  
Samsaen Nai, Payathai  
Bangkok 10400 - Thailand  
Tel: (66 2) 619-3530 - Fax: (66 2) 619-3069

### Research & Development

Charlotte - U.S.A.  
Greenville - U.S.A.  
Ladoux - France

### Retread Service Centers

Bourges - France  
Cuneo - Italy  
Kansas City - U.S.A.  
Nong Khae - Thailand  
Norwood - U.S.A.

### Manufacturing Plants

Bourges - France  
Nong Khae - Thailand  
Norwood - U.S.A.

[www.michelin.com/aviation](http://www.michelin.com/aviation)

