

# V-Series

## V-Series

### CONTURA SWITCHES

Carling Technologies' sealed V-Series Contura switches are well known for their cutting edge design, high quality, maximum performance and unmatched reliability. These switches are a staple in the marine and transportation industries and have passed a range of environmental, corrosion, temperature, vibration, shock and sealing tests including MIL Std 202F, MIL Std 510.1, UL 1500, ISO 8846, IEC 60529 and BS 5490 among others, making them one of the most rugged and reliable switches ever manufactured.



#### Resources:

[Download 3D CAD Files](#)

[IGS >](#) [STP >](#)

[Watch Product Video](#)



#### Product Highlights:

- ♦ Certified to IP66/68 with dual seals around lamps and rocker stem.
- ♦ Silver plated butt contact mechanism provides reliability up to and beyond 100K electrical cycles
- ♦ Greaseless construction withstands temperature extremes down to -40°C
- ♦ The switch accommodates up to 10 terminals and endless illumination and circuit options.
- ♦ The switch connector allows the user to preload FQC terminals for ease of assembly.
- ♦ Numerous choices of removable rockers allow for style change without having to retest or re-qualify the switch base.

#### Typical Applications:

- ♦ Marine Panels
- ♦ Emergency Vehicles
- ♦ Trucks
- ♦ Buses
- ♦ Construction Equipment
- ♦ Motorcycles & ATVs
- ♦ Farm Equipment
- ♦ Commercial Appliances
- ♦ Military Vehicles
- ♦ Mining Equipment
- ♦ Golf Carts
- ♦ Floor Cleaning Equipment
- ♦ Utility Vehicles



**Carling Technologies®**

Innovative Designs. Powerful Solutions.

**Carling Technologies, Inc.**

60 Johnson Avenue, Plainville, CT 06062

Email: [sales@carlingtech.com](mailto:sales@carlingtech.com)

Application Support: [team2@carlingtech.com](mailto:team2@carlingtech.com)

Phone: 860.793.9281 Fax: 860.793.9231

[www.carlingtech.com](http://www.carlingtech.com)

# V-Series Switch

## DESIGN FEATURES

### INTERCHANGEABLE ACTUATORS

Panel redesign is a snap with our wide range of rocker styles. Achieve maximum design variety with minimum inventory. Simply swap rockers to create an entirely new look for your panel.

### DUAL SEAL PROTECTION

Seals out water, dust, debris, and enables switch certification to IP66/68 for front panel components.

### CLEAN CONNECTIONS

Options for both eight and ten terminal base styles with AMP & Packard compatible connectors affords myriad circuit options while providing ease of assembly.

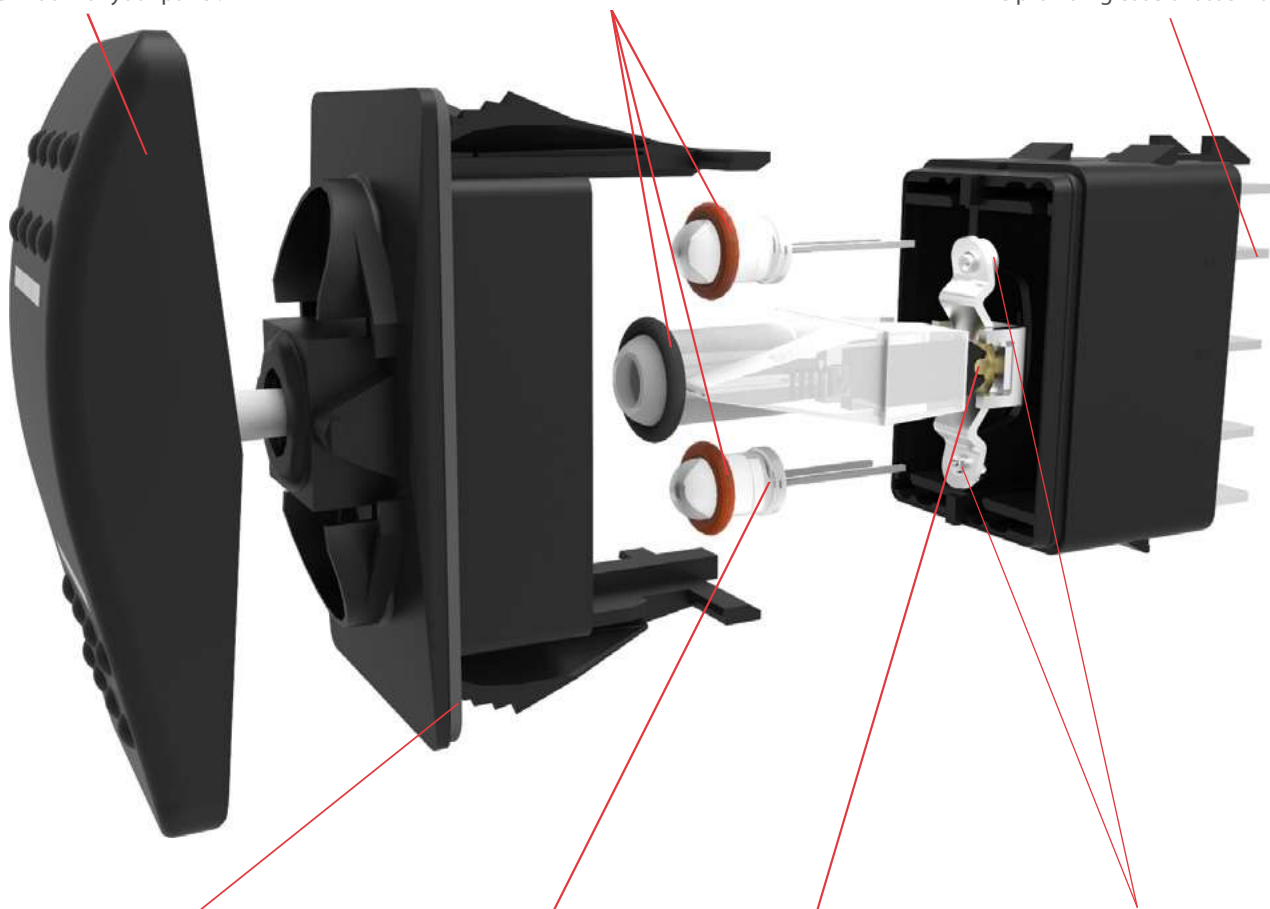

### OPTIONAL PANEL SEAL

Prevents water/dust ingress behind panel.

### MULTIPLE LIGHTING OPTIONS

In addition to Incandescent lamps, our LED illumination is offered in a wide array of light intensities, colors, as well as dual level, tri-color, and flashing options.

### BRASS ROLLER PIN

Robust mechanism eliminates the need for lubricants. Enables switch to withstand -40°C to +85°C temperatures.

### SILVER PLATED BUTT CONTACT MECHANISM

Providing 50k to 100k electrical cycles and a variety of different electrical ratings.

\*Manufacturer reserves the right to change product specification without prior notice.

### Contura II & III

The Contura II & III actuators are constructed of thermoplastic polycarbonate and are offered with a hard nylon overlay or a "soft-touch" elastomer overlay. These models incorporate aesthetic designs on the top and bottom of the rocker featuring two rows of raised "bumps" on the Contura II and three "indented" lines on the Contura III.



### Contura X

The raised bracket/bezel on the Contura X helps prevent inadvertent actuation of the rocker, as well as preventing debris from being trapped under the actuator. This curved rocker style is available with a variety of lenses and legends.



### Contura IV

The Contura IV's "Shape to create a Shape" actuator works with the curves, contours & advanced styling of the latest panel designs, flowing with these advanced curves & radii. This actuator style fits on the Contura flush bracket/bezel.



### Contura XI

The raised bracket/bezel on the Contura XI helps prevent inadvertent actuation of the rocker, as well as preventing debris from being trapped under the actuator. This convex style rocker is available with a wide variety of lenses and legends.



### Contura V

The symmetrically curved Contura V actuator provides the perfect complement to the Contura IV's "Shape to create a Shape" design concept. With its flush style mounting bracket, Contura V can be mounted in between two Contura IV's, by itself, or in groups.



### Contura XII

The Contura XII version features a paddle style actuator with the raised bracket/bezel of Contura X and XI. The contoured handle design provides intuitive recognition and ease of operation and is available with all Contura X and XI lens and legend offerings.



### Contura VI (WAVE)

The Contura VI WAVE sealed rocker switches, when used in a row, create a uniquely appealing "wave" design on your panel. A variety of colors and finishes are available for both rocker and wave insert. Contura VI features bar and oval lenses.



### Contura XIV

The Contura XIV represents a sleek new crossover rocker design which should appeal to Trucks, Buses and Heavy Vehicles as well as the Marine Industry. Intuitive feel is provided by recessed ridges along with a Center Groove which effectively defines the boundary between top and bottom switch functions.



### Contura VII

Contura VII featuring gently curved corners and edges assuring compatibility with most any panel design. Intuitive feel is maximized by the use of 2 embossed circular pads located at opposite ends of the rocker. Any combination of Bar or Oval style lenses can be located in the pads providing a truly unique look, exclusive to Contura VII.



### Illuminated Indicators & Accessories

Alert operator of systems functions or malfunctions, are offered with removable/replaceable lamps in Contura II, II, V or X styles. Accessories include connectors, mounting panels, hole plugs, panel seals, and actuator removal tools. Refer to accessories page for full details



**Electrical**

|                            |   |
|----------------------------|---|
| Contact Rating             | .4VA @ 24VDC (MAX) resistive<br>15 amps, 125VAC<br>10 amps, 250VAC<br>1/2 HP 125-250VAC<br>20 amps, 4-14VDC<br>15 amps, 15-28VDC<br>10A, 14VT<br>6A, 125VAC L |
| Dielectric Strength        | 1500 Volts RMS  |
| Insulation Resistance      | 50 Megohms  |
| Initial Contact Resistance | 10 milliohms max. @ 4VDC  |
| Life                       | 50,000 - 100,000 cycles circuit dependent   |
| Contacts                   | Silver alloy, silver tin-oxide, fine silver   |
| Terminals                  | Brass or copper/silver plate 1/4" (6.3mm) Quick Connect terminations standard. Solder lug, Wire Lead  |

**Mechanical**

|           |  |
|-----------|--|
| Endurance | 150,000 cycles minimum circuit dependent |
|-----------|--|

**Physical**

|                                       |   |
|---------------------------------------|---|
| Lighted                               | Incandescent - rated 10,000 hours Neon - rated 25,000 hours LED - rated 100,000 hours 1/2 life (LED is internally ballasted for voltages to 24VDC)  |
| Seals                                 | Internal  |
| Base                                  | Optional external gasket panel seal Polyester blend rated to 125°C with a UL flammability rating of 94V0.   |
| Contura II,III,IV,V, VI, VII Actuator | <b>Hard Surface:</b> Basic actuator structure molded of thermoplastic polycarbonate with a hard Nylon 66 thermoplastic surface overlay.<br><b>Soft Surface:</b> Basic actuator structure molded of thermoplastic polycarbonate with an elastomer overlay. |
| Contura X,XI,XII Actuator,VP          | Nylon 66 Reinforced rated to 105°C  |
| Lens                                  | Polycarbonate rated at 100°C  |
| Contura XIV                           | Polycarbonate lens/sub-rocker with ABS shell  |

**Actuator Travel (Angular Displacement)**

|             |                |
|-------------|----------------|
| 2 position  | 18°            |
| 3 positions | 9° from center |

**Mounting Specifications**

Panel Thickness Range

**Gaskets Acceptable Panel Thickness**

|   |  |
|---|--|
| 0 | .030 to .250 (.76 to 6.35mm)                                 |
| 1 | .030 to .109 & .147 to .157 (.76 to 2.77mm & 3.73 to 3.98mm) |

Recommended: No gasket with panel thickness of .032, .062, .093, .125, .187 or .250

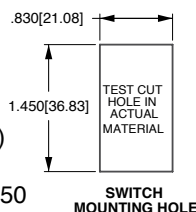

**Agency Certifications**



**Environmental**

|                     |   |
|---------------------|---|
| Sealing             | Sealed version: IP66/68, this rating applies to front panel components of the actual switch only, and signifies complete protection against dust as well as powerful jets of water.   |
| Corrosion           | Mixed Flowing Gas (MFG) Class III 3 year accelerated exposure per ASTM B-827, B-845 Silver and gold contacts  |
| Operating Temp.     | -40°C to +85°C  |
| Vibration 1         | Per Mil-Std 202F, Method 204D Test Condition A 0.06 DA or 10G's 10-500 Hz. Tested with VCH connector. Test criteria - No loss of circuit during test, pre and post test contact resistance.   |
| Vibration 2         | Resonance search<br>24-50 Hz 0.40 DA<br>50-2000 Hz ±10 G's peak<br>Horizontal Axis 3-5 G's max.<br>Random<br>24 Hz 0.06 PSD-Gsq/Hz<br>60 Hz 0.50<br>100 Hz 0.50<br>200 Hz 0.025<br>2000 Hz 0.025<br>No loss of circuit during test; <10µ seconds chatter. |
| Shock               | Per Mil-Std 202F, Method 213B, Test Condition K @ 30G's. Tested with VCH connector. Test criteria - No loss of circuit during test, pre and post test contact resistance.   |
| Salt Spray          | Per Mil-Std 202F, Method 101D, Test Condition A, 96 Hrs. Sealed version only.   |
| Dust                | Mil STD 810, Method 510.2 Air Velocity 300 Ft/Min Duration 16Hr   |
| Thermal Shock       | Per Mil-Std 202F, Method 107F, Test Cond. A, -55°C to +85°C. Test criteria - pre and post test contact resistance   |
| Moisture Resistance | Per Mil-Std 202F, Method 106F, Test Criteria - pre and post test contact resistance   |
| Ignition Protection | All Contura switches with sealed construction meet the requirements of UL1500/ISO8846 for ignition protection, in addition to conformance with EC directive 94/25/EC for marine products.   |

**V 1 D A B T O B - A R B 00 - 0 00**

1 Series 2 Circuit 3 Rating 4 Termination Illumination Lamp 5 Lamp 6 Lamp 7 Lamp 8 Bracket 9 Actuator 10 Lens 11 Color 12 Legend 13 Legend Orientation 14 Actuator Lens Legend

**1 SERIES**

V

**2 CIRCUIT**

Terminal Connections as viewed ( ) - momentary from bottom of switch: SP - single pole - uses terminals 1, 2 & 3. DP - double pole uses terminals 1, 2, 3, 4, 5 & 6. **8 terminal 10 terminal** DP - double pole uses terminals 1, 2, 3, 4, 5 & 6. Terminals 7, 8, 9 & 10 for lamp circuit only.

8 - -7 8 - -7  
1 - -4 1 - -4  
2 - -5 2 - -5  
3 - -6 3 - -6  
10 - -9

| Position: | 1            | 2                   | 3            |
|-----------|--------------|---------------------|--------------|
| SP DP     | 2 & 3, 5 & 6 | Connected Terminals | 1 & 2, 4 & 5 |
| 1 A       | ON           | NONE                | OFF          |
| 2 B       | (ON)         | NONE                | OFF          |
| 3 C       | ON           | NONE                | (OFF)        |
| 4 D       | ON           | NONE                | ON           |
| 5 F       | ON           | NONE                | (ON)         |
| 6 J       | ON           | OFF                 | ON           |
| 7 K       | ON           | OFF                 | (ON)         |
| 8 L       | (ON)         | OFF                 | (ON)         |

**SPECIAL CIRCUITS**

|    | 2 & 3          | 2 & 3, 5 & 4 | 5 & 4 |
|----|----------------|--------------|-------|
| H* | 2 & 3          | 2 & 3, 5 & 4 | 5 & 4 |
| G* | 2 & 3, 5 & 6   | 2 & 3        | OFF   |
| S* | 2 & 3, 5 & 6   | 2 & 3        | 1 & 2 |
| M* | (2 & 3, 5 & 6) | 2 & 3        | OFF   |
| R* | (2 & 3, 5 & 6) | 2 & 3        | 2 & 1 |
| E* | 5 & 6          | 5 & 3        | 5 & 1 |

\*Jumper between terminals 2 & 5 for circuits H, G, M, R & S are specified in selection 4. External jumper between terminals 2 & 4 for circuit E are provided by customer. Circuit E may be used for SP OFF-ON-ON circuit.

**3 RATING 3**

|   |  |
|---|--|
| 1 | .4VA @ 28VDC Resistive                       |
| B | 15A 24V                                      |
| C | 20A 18V                                      |
| D | 20A 12V                                      |
| E | 20A 14V, 10A 14VT (circuit 1, 4, A & D only) |
| F | 10A 14V, 6A 14VT (circuit G only)            |
| M | .4VA/20A 12V                                 |
| N | .4VA/15A 24V                                 |

**4 TERMINATION / BASE STYLE**

| 8 term | 10 Term | Termination                 | Jumper      |
|--------|---------|-----------------------------|-------------|
| 1      | 2       | .250 TAB (QC) no barriers   | No          |
| A      | B       | .250 TAB (QC) with barriers | No          |
| J      | K       | .250 TAB (QC) no barriers   | Yes T2 to 5 |
| 3      | 5       | Solder Lug no barriers      | No          |
| C      | D       | Solder Lug                  | No          |
| 5      | 6       | Wire Leads no barriers      | No          |
| E      | F       | Wire Leads                  | No          |

Note: Codes J & K for circuits H, G & M.

**5 ILLUMINATION**

Lamp #1: above terminals 1 & 4 end of switch.; Lamp #2 above terminals 3 & 6 end of switch. Positive (+) and negative (-) symbols apply to LED lamps only

| Sealed                           | Unsealed | Lamps | Illumination Type | Lamp wired to Terminals |
|----------------------------------|----------|-------|-------------------|-------------------------|
| S                                | 0        | NONE  | -                 | -                       |
| A                                | 1        | 1     | INDEPENDENT       | 8 (+) 7 (-)             |
| B                                | 2        | 1     | DOWN              | 3 (+) 7 (-)             |
| C                                | 3        | 2     | UP                | 3 (+) 7 (-)             |
| D                                | 4        | 1     | DOWN              | 3 (+) 7 (-)             |
|                                  |          | 2     | DOWN              | 1 (+) 7 (-)             |
| E                                | 5        | 1     | UP                | 1 (+) 7 (-)             |
|                                  |          | 2     | UP                | 3 (+) 7 (-)             |
| F                                | 6        | 1     | INDEPENDENT       | 8 (+) 7 (-)             |
|                                  |          | 2     | UP                | 3 (+) 6 (-)             |
| G                                | 7        | 1     | INDEPENDENT       | 8 (+) 7 (-)             |
|                                  |          | 2     | UP                | 3 (+) 7 (-)             |
| H                                | Z        | 2     | INDEPENDENT       | 8 (+) 7 (-)             |
| U                                | Y        | 1     | INDEPENDENT       | 8 (+) 7 (-)             |
|                                  |          | 2     | INDEPENDENT       | 10 (+) 9 (-)            |
| <b>SINGLE POLE SWITCHES ONLY</b> |          |       |                   |                         |
| J                                | 8        | 1     | DOWN              | 3 (+) 8 (-)             |
|                                  |          | 2     | INDEPENDENT       | 6 (+) 7 (-)             |
| K                                | W        | 1     | INDEPENDENT       | 8 (+) 7 (-)             |
|                                  |          | 2     | INDEPENDENT       | 6 (+) 7 (-)             |
| <b>DOUBLE POLE SWITCHES ONLY</b> |          |       |                   |                         |
| L                                | 9        | 1     | DOWN              | 3 (+) 6 (-)             |
| M                                | R        | 1     | UP                | 3 (+) 6 (-)             |
| N                                | T        | 1     | DOWN              | 3 (+) 6 (-)             |
|                                  |          | 2     | DOWN              | 1 (+) 4 (-)             |
| P                                | V        | 1     | UP                | 1 (+) 4 (-)             |
|                                  |          | 2     | UP                | 3 (+) 6 (-)             |

**6,7 LAMP (SAME CODING FOR BOTH SELECTIONS)**

Selection 6: above terminals 1 & 4; Selection 7: above terminals 3 & 6

|                   |          |          |                   |                   |                   |
|-------------------|----------|----------|-------------------|-------------------|-------------------|
| No lamp           | 0        | 2 250VAC |                   |                   |                   |
| Neon              | 1 125VAC | 5 6V     | 6 12V superbright | 7 18V superbright | 8 24V superbright |
| Incandescent LED* | 4 3V     |          | Green             | Red               |                   |
|                   | Red      | Amber    | F                 | R                 |                   |
| 2VDC              | A        | L        | G                 | S                 |                   |
| 6VDC              | B        | M        | H                 | T                 |                   |
| 12VDC             | C        | N        | J                 | V                 |                   |
| 24VDC             | D        | P        | K                 | W                 |                   |
|                   |          |          | L                 | X                 |                   |
|                   |          |          | M                 | Y                 |                   |
|                   |          |          | N                 | Z                 |                   |

\* Consult factory for "daylight bright" LED options. Typical current draw for LED is 20ma.

**8 FLUSH BRACKET COLOR 1, PANEL SEAL**

|          |       |       |      |
|----------|-------|-------|------|
| No Seal  | Black | White | Gray |
| One Seal | B     | W     | G    |
|          | C     | Y     | H    |

**9 ACTUATOR**

|      |             |
|------|-------------|
| 0    | No Actuator |
| A, B | Contura II  |
| C, D | Contura III |

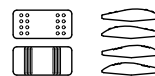

Actuator orientation above terminals: 3,6 1,4

**10 LENS**

| 0 - No Actuator | Z - No Lens |                |
|-----------------|-------------|----------------|
| Clear White     | Amber       | Green Red Blue |
| 1 6             | 8           | G M T          |
| 2 7             | C           | H N U          |
| 3 8             | D           | J P V          |
| 4 9             | E           | K R W          |
| 5 A             | F           | L S Y          |

Lens color for LEDs must be clear, white, or match color of LED. Green or blue lenses are not recommended with Neon lamps.

**11 ACTUATOR COLOR 1 AND TEXTURE**

|                 |       |      |     |       |
|-----------------|-------|------|-----|-------|
| 0 - No Actuator | Black | Gray | Red | White |
| Soft Surface    | B     | G    | R   | W     |
| Hard Surface    | C     | H    | S   | Y     |

**12 ACTUATOR LENS OR BODY LEGENDS 2**

|        |        |        |        |
|--------|--------|--------|--------|
| 11 ON  | 12 OFF | 13 I   | 14 O   |
| OFF    | ON     | O      | I      |
| 15 O O | 16 O O | 17 O I | 18 I O |
| F N    | N F    | F      |        |

For additional legend options & codes, visit us at [www.carlingtech.com](http://www.carlingtech.com).

**13 LEGEND ORIENTATION**

0 No legend (used with codes 11-18 in selection 12)

|   |               |
|---|---------------|
| 1 | Orientation 1 |
| 2 | Orientation 2 |
| 3 | Orientation 3 |
| 4 | Orientation 4 |

**14 ACTUATOR LENS LEGEND**

00 No legend this location / no actuator (used with codes 11-18 in selection 12) Selection 14 required when switch requires two legends. If the two legends consist of one lens and one body legend, lens legend must be specified in selection 12; body legend specified in selection 14. For legend options & codes, visit us at [www.carlingtech.com](http://www.carlingtech.com).

Notes:

- Consult factory to verify horsepower rating for your particular circuit choice.
- 1 Custom colors are available. Consult factory.
- 2 Body legends not available on Soft surface actuators; White imprinting is standard on black actuators; Black imprinting is standard on white, red and gray actuators. Custom colors are available, consult factory.
- 3 Additional ratings available. See V-Series Switch Accessories page.
- 4 Contura II available with two square lenses. Consult factory for details.

**V 1 D A S W O B - A Z E 00 - 0**

1 Series    2 Circuit    3 Rating    4 Termination Illumination Lock    5 Lamp    6 Bracket    7 Actuator    8 Lens    9 Function    10 Legend    11 Legend    12 Legend    13 Legend Orientation

**1 SERIES**  
V

**2 CIRCUIT**  
Terminal Connections as viewed ( ) - momentary from bottom of switch: SP - single pole - uses terminals 1, 2 & 3. DP - double pole uses terminals 1, 2, 3, 4, 5 & 6.  
**8 terminal 10 terminal** Terminals 7, 8, 9 & 10 for lamp circuit only.

|     |     |      |     |   |  |
|-----|-----|------|-----|---|--|
| 8 - | - 7 | 8 -  | - 7 | Terminals 7, 8, 9 & 10 for lamp circuit only. |  |
| 1 - | - 4 | 1 -  | - 4 |   |  |
| 2 - | - 5 | 2 -  | - 5 |   |  |
| 3 - | - 6 | 3 -  | - 6 |   |  |
|     |     | 10 - | - 9 |   |  |

**Position:**

| SP | DP | 1    | 2    | 3    |
|----|----|------|------|------|
| 1  | A  | ON   | NONE | OFF  |
| 4  | D  | ON   | NONE | ON   |
| 6  | J  | ON   | OFF  | ON   |
| 7  | K  | ON   | OFF  | (ON) |
| 8  | L  | (ON) | OFF  | (ON) |
| 9  | N  | OFF  | NONE | ON   |

**SPECIAL CIRCUITS**

|    | 2 & 3          | 2 & 3, 5 & 6 | 2 & 3, 5 & 4 | 5 & 4 |
|----|----------------|--------------|--------------|-------|
| H* | 2 & 3          | 2 & 3, 5 & 6 | 2 & 3        | 5 & 4 |
| G* | 2 & 3          | 2 & 3, 5 & 6 | 2 & 3        | OFF   |
| S* | 2 & 3          | 2 & 3, 5 & 6 | 2 & 3        | 1 & 2 |
| M* | (2 & 3, 5 & 6) | 2 & 3        | 2 & 3        | OFF   |
| R* | (2 & 3, 5 & 6) | 2 & 3        | 2 & 3        | 2 & 1 |
| E* | 5 & 6          | 5 & 3        | 5 & 3        | 5 & 1 |

\*Jumper between terminals 2 & 5 for circuits H,G,M,R & S are specified in selection 4. External jumper between terminals 2 & 4 for circuit E are provided by customer. Circuit E may be used for SP OFF-ON-ON circuit.

**3 RATING 4**

1 .4VA @ 28VDC Resistive  
 B 15A 24V  
 C 20A 18V  
 D 20A 12V  
 E 20A 14V, 10A 14VT (circuit 1, 4, A & D only)  
 F 10A 14V, 6A 14VT (circuit G only)  
 M 4VA/20A 12V  
 N .4VA/15A 24V

**4 TERMINATION / BASE STYLE**

| 8 term | 10 Term | Termination                 | Jumper      |
|--------|---------|-----------------------------|-------------|
| 1      | 2       | .250 TAB (QC) no barriers   | No          |
| A      | B       | .250 TAB (QC) with barriers | No          |
| J      | K       | .250 TAB (QC) no barriers   | Yes T2 to 5 |
| 3      | 5       | Solder Lug no barriers      | No          |
| C      | D       | Solder Lug                  | No          |
| E      | F       | Wire Leads no barriers      | No          |
| 5      | F       | Wire Leads                  | No          |

Note: Codes J & K for circuits H, G & M.

**5 ILLUMINATION & SWITCH SEALING**  
Lamp #1: above terminals 1 & 4 end of switch.; Lamp #2 above terminals 3 & 6 end of switch. Positive (+) and negative (-) symbols apply to LED lamps only

| Sealed                           | Unsealed | Lamps | Illumination Type | Lamp wired to Terminals |
|----------------------------------|----------|-------|-------------------|-------------------------|
| S                                | 0        | NONE  | -                 | 3 (+) 7 (-)             |
| H                                | 3        | 2     | UP                | 8 (+) 7 (-)             |
| C                                | Z        | 2     | INDEPENDENT       | 8 (+) 7 (-)             |
| <b>DOUBLE POLE SWITCHES ONLY</b> |          |       |                   |                         |
| M                                | R        | 1     | UP                | 3 (+) 6 (-)             |

**6 LOCK**  
Lock above terminals 1 & 4 end of switch  
W lock

**7 LAMP**  
Lamp above terminals 3 & 6 end of switch

|              |   |        |   |                       |                       |
|--------------|---|--------|---|-----------------------|-----------------------|
| No lamp      | 0 |        |   |                       |                       |
| Neon         | 1 | 125VAC | 2 | 250VAC                |                       |
| Incandescent | 4 | 3V     | 5 | 6V                    |                       |
| LED*         |   |        | 6 | 12V superbright Green | 7 18V superbright Red |
| 2VDC         | A | Red    | L | Amber                 | F                     |
| 6VDC         | B |        | M |                       | G                     |
| 12VDC        | C |        | N |                       | H                     |
| 24VDC        | D |        | P |                       | J                     |
|              |   |        |   |                       | K                     |
|              |   |        |   |                       | L                     |
|              |   |        |   |                       | M                     |
|              |   |        |   |                       | N                     |
|              |   |        |   |                       | O                     |
|              |   |        |   |                       | P                     |
|              |   |        |   |                       | Q                     |
|              |   |        |   |                       | R                     |
|              |   |        |   |                       | S                     |
|              |   |        |   |                       | T                     |
|              |   |        |   |                       | U                     |
|              |   |        |   |                       | V                     |

\* Consult factory for "daylight bright" LED options. Typical current draw for LED is 20ma.

**8 FLUSH BRACKET COLOR 1, PANEL SEAL**

|          |       |       |      |
|----------|-------|-------|------|
|          | Black | White | Gray |
| No Seal  | B     | W     | G    |
| One Seal | C     | Y     | H    |

**9 HARD SURFACE ACTUATOR 1**

|             |       |      |     |       |
|-------------|-------|------|-----|-------|
|             | Black | Gray | Red | White |
| Contura II  | A     | B    | G   | H     |
| Contura III | C     | D    | E   | F     |

Actuator orientation above terminals:

**10 LENS**  
Z - No Lens  
Clear White Amber Green Red Blue

|   |   |   |   |   |   |
|---|---|---|---|---|---|
| 3 | 8 | D | J | P | V |
|---|---|---|---|---|---|

Lens color for LEDs must be clear, white, or match color of LED. Green or blue lenses are not recommended with Neon lamps.

**11 ACTUATOR LOCK FUNCTION AND COLOR 1**

| Lock Color     | Up | Down | Up & Down | Center 3 |
|----------------|----|------|-----------|----------|
| Match Actuator | A  | H    | R         | 1        |
| Black          | B  | J    | S         | 2        |
| White          | C  | K    | T         | 3        |
| Red            | D  | L    | V         | 4        |
| Safety Orange  | E  | M    | W         | 5        |

**12 ACTUATOR LENS OR BODY LEGEND 2**  
00 - No Legend

|     |    |    |    |
|-----|----|----|----|
| 21  | 22 | 23 | 24 |
| OFF | ON | O  | I  |
| 25  | O  | 26 | O  |
| F   | N  | 27 | O  |
|     |    | 28 | I  |
|     |    |    | F  |

For additional legend options & codes, visit us at [www.carlingtech.com](http://www.carlingtech.com).

**13 LEGEND ORIENTATION**

|   |   |
|---|---|
| 0 | No legend (used with codes 21-28 in selection 12) |
| 1 | Orientation 1                                     |
| 2 | Orientation 2                                     |
| 3 | Orientation 3                                     |
| 4 | Orientation 4                                     |

Notes:  
 Consult factory to verify horsepower rating for your particular circuit choice.  
 1 Custom colors are available. Consult factory.  
 2 White imprinting is standard on black actuators; Black imprinting is standard on white, red and gray actuators. Custom colors are available, consult factory.  
 3 Only available with 3 position circuits. Center OFF and special circuits only available with center position lock function.  
 4 Additional ratings available. See V-Series Switch Accessories page.

V 1 D A B T O B - E P C 00 - 0 00

1 Series 2 Circuit 3 Rating 4 Termination Illumination Lamp 5 Lamp 6 Lamp 7 Lamp 8 Bracket 9 Actuator 10 Lens 11 Color 12 Legend 13 Legend Orientation 14 Actuator Lens Legend

**1 SERIES**

V

**2 CIRCUIT**

Terminal Connections as viewed ( ) - momentary from bottom of switch: SP - single pole - uses terminals 1, 2 & 3. **8 terminal 10 terminal** DP - double pole uses terminals 1, 2, 3, 4, 5 & 6. Terminals 7, 8, 9 & 10 for lamp circuit only.

8 - -7 8 - -7  
1 - -4 1 - -4  
2 - -5 2 - -5  
3 - -6 3 - -6  
10 - -9

| Position: | 1            | 2                   | 3            |
|-----------|--------------|---------------------|--------------|
| SP DP     | 2 & 3, 5 & 6 | Connected Terminals | 1 & 2, 4 & 5 |
| 1 A       | ON           | NONE                | OFF          |
| 2 B       | (ON)         | NONE                | OFF          |
| 3 C       | ON           | NONE                | (OFF)        |
| 4 D       | ON           | NONE                | ON           |
| 5 F       | ON           | NONE                | (ON)         |
| 6 J       | ON           | OFF                 | ON           |
| 7 K       | ON           | OFF                 | (ON)         |
| 8 L       | (ON)         | OFF                 | (ON)         |

**SPECIAL CIRCUITS**

|    |                |              |       |
|----|----------------|--------------|-------|
| H* | 2 & 3          | 2 & 3, 5 & 4 | 5 & 4 |
| G* | 2 & 3, 5 & 6   | 2 & 3        | OFF   |
| S* | 2 & 3, 5 & 6   | 2 & 3        | 1 & 2 |
| M* | (2 & 3, 5 & 6) | 2 & 3        | OFF   |
| R* | (2 & 3, 5 & 6) | 2 & 3        | 2 & 1 |
| E* | 5 & 6          | 5 & 3        | 5 & 1 |

\*Jumper between terminals 2 & 5 for circuits H,G,M,R & S are specified in selection 4. External jumper between terminals 2 & 4 for circuit E are provided by customer. Circuit E may be used for SP OFF-ON-ON circuit.

**3 RATING 4**

- 1 .4VA @ 28VDC Resistive
- B 15A 24V
- C 20A 18V
- D 20A 12V
- E 20A 14V, 10A 14VT (circuit 1, 4, A & D only)
- F 10A 14V, 6A 14VT (circuit G only)
- M .4VA/20A 12V
- N .4VA/15A 24V

**4 TERMINATION / BASE STYLE**

| 8 term | 10 Term | Termination                 | Jumper      |
|--------|---------|-----------------------------|-------------|
| 1      | 2       | .250 TAB (QC) no barriers   | No          |
| A      | B       | .250 TAB (QC) with barriers | No          |
| J      | K       | .250 TAB (QC) no barriers   | Yes T2 to 5 |
| 3      | 5       | Solder Lug no barriers      | No          |
| C      | D       | Solder Lug                  | No          |
| 5      | 6       | Wire Leads no barriers      | No          |
| E      | F       | Wire Leads                  | No          |

Note: Codes J & K for circuits H, G & M.

**5 ILLUMINATION & SWITCH SEALING**

Lamp #1: above terminals 1 & 4 end of switch.; Lamp #2 above terminals 3 & 6 end of switch. Positive (+) and negative (-) symbols apply to LED lamps only

| Sealed                           | Unsealed | Lamps | Illumination Type | Lamp wired to Terminals |
|----------------------------------|----------|-------|-------------------|-------------------------|
| S                                | 0        | NONE  | -                 | -                       |
| A                                | 1        | 1     | INDEPENDENT       | 8 (+) 7 (-)             |
| B                                | 2        | 1     | DOWN              | 3 (+) 7 (-)             |
| C                                | 3        | 2     | UP                | 3 (+) 7 (-)             |
| D                                | 4        | 1     | DOWN              | 3 (+) 7 (-)             |
| E                                | 5        | 2     | DOWN              | 1 (+) 7 (-)             |
| F                                | 6        | 1     | UP                | 1 (+) 7 (-)             |
| G                                | 7        | 2     | UP                | 3 (+) 7 (-)             |
| H                                | Z        | 2     | INDEPENDENT       | 8 (+) 7 (-)             |
| U                                | Y        | 1     | INDEPENDENT       | 8 (+) 7 (-)             |
|                                  |          | 2     | INDEPENDENT       | 10 (+) 9 (-)            |
| <b>SINGLE POLE SWITCHES ONLY</b> |          |       |                   |                         |
| J                                | 8        | 1     | DOWN              | 3 (+) 8 (-)             |
| K                                | W        | 2     | INDEPENDENT       | 6 (+) 7 (-)             |
|                                  |          | 1     | INDEPENDENT       | 8 (+) 7 (-)             |
|                                  |          | 2     | INDEPENDENT       | 6 (+) 7 (-)             |
| <b>DOUBLE POLE SWITCHES ONLY</b> |          |       |                   |                         |
| L                                | 9        | 1     | DOWN              | 3 (+) 6 (-)             |
| M                                | R        | 1     | UP                | 3 (+) 6 (-)             |
| N                                | T        | 1     | DOWN              | 3 (+) 6 (-)             |
|                                  |          | 2     | DOWN              | 1 (+) 4 (-)             |
| P                                | V        | 1     | UP                | 1 (+) 4 (-)             |
|                                  |          | 2     | UP                | 3 (+) 6 (-)             |

**6,7 LAMP (SAME CODING FOR BOTH SELECTIONS)**

Selection 6: above terminals 1 & 4; Selection 7: above terminals 3 & 6

|                   |   |        |   |        |                         |
|-------------------|---|--------|---|--------|-------------------------|
| No lamp           | 0 |        |   |        |                         |
| Neon              | 1 | 125VAC | 2 | 250VAC |                         |
| Incandescent LED* | 4 | 3V     | 5 | 6V     | 6 12V superbright Green |
|                   |   |        |   |        | 7 18V superbright Red   |
|                   |   |        |   |        | 8 24V superbright Red   |
| 2VDC              | A | Red    | L | Amber  | F                       |
| 6VDC              | B |        | M |        | G                       |
| 12VDC             | C |        | N |        | H                       |
| 24VDC             | D |        | P |        | JV                      |

\* Consult factory for "daylight bright" LED options. Typical current draw for LED is 20ma.

**8 FLUSH BRACKET COLOR 1, PANEL SEAL**

|          |       |       |      |
|----------|-------|-------|------|
| No Seal  | Black | White | Gray |
| One Seal | B     | W     | H    |
|          | C     | Y     |      |

**9 ACTUATOR**

- 0 No Actuator
  - E Contura IV, left orientation
  - T Contura IV, left orientation, laser etched
  - F Contura IV, right orientation
  - R Contura IV, right orientation, laser etched
- Actuator orientation above terminals:



**10 LENS**

| 0 - No Actuator | Z - No Lens | Green | Red | Blue |
|-----------------|-------------|-------|-----|------|
| Clear White     | Amber       |       |     |      |
| 1 6             | 8           | G     | M   | T    |
| 2 7             | C           | H     | N   | U    |
| 3 8             | D           | J     | P   | V    |
| 4 9             | E           | K     | R   | W    |
| 5 A             | F           | L     | S   | Y    |

Lens color for LEDs must be clear, white, or match color of LED. Green or blue lenses are not recommended with Neon lamps.

**11 ACTUATOR COLOR 1,5,6**

|             |   |        |   |        |   |     |   |
|-------------|---|--------|---|--------|---|-----|---|
| No Actuator | 0 | Black  | C | Gray   | H | Red | S |
| White       | Y | Nickel | D | Pewter | E |     |   |

**12 ACTUATOR LENS OR BODY LEGENDS 2**

|        |        |        |        |
|--------|--------|--------|--------|
| 11 ON  | 12 OFF | 13 I   | 14 O   |
|        | OFF    | ON     | O      |
| 15 O O | 16 O O | 17 O I | 18 I O |
| F N    | N F    | F      |        |

For additional legend options & codes, visit us at [www.carlingtech.com](http://www.carlingtech.com).

**13 LEGEND ORIENTATION**

- 0 No legend (used with codes 11-18 in selection 12)
- 1 Orientation 1
- 2 Orientation 2
- 3 Orientation 3
- 4 Orientation 4

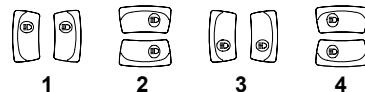

**14 ACTUATOR LENS LEGEND**

00 No legend this location / no actuator (used with codes 11-18 in selection 12) Selection 14 required when switch requires two legends. If the two legends consist of one lens and one body legend, lens legend must be specified in selection 12; body legend specified in selection 14. For legend options & codes, visit us at [www.carlingtech.com](http://www.carlingtech.com).

**Notes:**

- 1 Consult factory to verify horsepower rating for your particular circuit choice.
- 2 Custom colors are available. Consult factory.
- 3 White imprinting is standard on black actuators; Black imprinting is standard on white, red and gray actuators. Custom colors are available, consult factory.
- 4 Gloss brow is on left side of E actuator and right side of F actuator.
- 5 Additional ratings available. See V-Series Switch Accessories page.
- 6 Laser etched rocker only available with lens code Z & actuator colors black, nickel or pewter.
- 7 Pewter and nickel colors only available with laser etched actuator.

**V 1 D A B T O B - G P C 00 - 0 00**

1 Series    2 Circuit    3 Rating    4 Termination Illumination    5 Lamp    6 Lamp    7 Lamp    8 Bracket    9 Actuator    10 Lens    11 Color    12 Legend    13 Legend    14 Actuator  
 Orientation    Lens Legend

**1 SERIES**  
V

**2 CIRCUIT**

Terminal Connections as viewed ( ) - momentary from bottom of switch: SP - single pole - uses terminals 1, 2 & 3. DP - double pole uses terminals 1, 2, 3, 4, 5 & 6. **8 terminal 10 terminal** Terminals 7, 8, 9 & 10 for lamp circuit only.

8 - -7    8 - -7  
 1 - -4    1 - -4  
 2 - -5    2 - -5  
 3 - -6    3 - -6  
 10 - -9

| Position: | 1            | 2                   | 3            |
|-----------|--------------|---------------------|--------------|
| SP DP     | 2 & 3, 5 & 6 | Connected Terminals | 1 & 2, 4 & 5 |
| 1 A       | ON           | NONE                | OFF          |
| 2 B       | (ON)         | NONE                | OFF          |
| 3 C       | (ON)         | NONE                | (OFF)        |
| 4 D       | ON           | NONE                | ON           |
| 5 F       | ON           | NONE                | (ON)         |
| 6 J       | ON           | OFF                 | ON           |
| 7 K       | ON           | OFF                 | (ON)         |
| 8 L       | (ON)         | OFF                 | (ON)         |

**SPECIAL CIRCUITS**

|    |                |              |       |
|----|----------------|--------------|-------|
| H* | 2 & 3          | 2 & 3, 5 & 4 | 5 & 4 |
| G* | 2 & 3, 5 & 6   | 2 & 3        | OFF   |
| S* | 2 & 3, 5 & 6   | 2 & 3        | 1 & 2 |
| M* | (2 & 3, 5 & 6) | 2 & 3        | OFF   |
| R* | (2 & 3, 5 & 6) | 2 & 3        | 2 & 1 |
| E* | 5 & 6          | 5 & 3        | 5 & 1 |

\*Jumper between terminals 2 & 5 for circuits H,G,M,R & S are specified in selection 4. External jumper between terminals 2 & 4 for circuit E are provided by customer. Circuit E may be used for SP OFF-ON-ON circuit.

**3 RATING 4**

- 1 .4VA @ 28VDC Resistive
- B 15A 24V
- C 20A 18V
- D 20A 12V
- E 20A 14V, 10A 14VT (circuit 1, 4, A & D only)
- F 10A 14V, 6A 14VT (circuit G only)
- M .4VA/20A 12V
- N .4VA/15A 24V

**4 TERMINATION / BASE STYLE**

| 8 term | 10 Term | Termination                 | Jumper      |
|--------|---------|-----------------------------|-------------|
| 1      | 2       | .250 TAB (QC) no barriers   | No          |
| A      | B       | .250 TAB (QC) with barriers | No          |
| J      | K       | .250 TAB (QC) no barriers   | Yes T2 to 5 |
| 3      | 5       | Solder Lug no barriers      | No          |
| C      | D       | Solder Lug                  | No          |
| 5      | 6       | Wire Leads no barriers      | No          |
| E      | F       | Wire Leads                  | No          |

Note: Codes J & K for circuits H, G & M.

**5 ILLUMINATION & SWITCH SEALING**

Lamp #1: above terminals 1 & 4 end of switch.; Lamp #2 above terminals 3 & 6 end of switch. Positive (+) and negative (-) symbols apply to LED lamps only

| Sealed                           | Unsealed | Lamps | Illumination Type | Lamp wired to Terminals |
|----------------------------------|----------|-------|-------------------|-------------------------|
| S                                | 0        | NONE  | -                 | -                       |
| A                                | 1        | 1     | INDEPENDENT       | 8 (+) 7 (-)             |
| B                                | 2        | 1     | DOWN              | 3 (+) 7 (-)             |
| C                                | 3        | 2     | UP                | 3 (+) 7 (-)             |
| D                                | 4        | 1     | DOWN              | 3 (+) 7 (-)             |
|                                  |          | 2     | DOWN              | 1 (+) 7 (-)             |
| E                                | 5        | 1     | UP                | 1 (+) 7 (-)             |
|                                  |          | 2     | UP                | 3 (+) 7 (-)             |
| F                                | 6        | 1     | INDEPENDENT       | 8 (+) 7 (-)             |
|                                  |          | 2     | UP                | 3 (+) 6 (-)             |
| G                                | 7        | 1     | INDEPENDENT       | 8 (+) 7 (-)             |
|                                  |          | 2     | UP                | 3 (+) 7 (-)             |
| H                                | Z        | 2     | INDEPENDENT       | 8 (+) 7 (-)             |
| U                                | Y        | 1     | INDEPENDENT       | 8 (+) 7 (-)             |
|                                  |          | 2     | INDEPENDENT       | 10 (+) 9 (-)            |
| <b>SINGLE POLE SWITCHES ONLY</b> |          |       |                   |                         |
| J                                | 8        | 1     | DOWN              | 3 (+) 8 (-)             |
|                                  |          | 2     | INDEPENDENT       | 6 (+) 7 (-)             |
| K                                | W        | 1     | INDEPENDENT       | 8 (+) 7 (-)             |
|                                  |          | 2     | INDEPENDENT       | 6 (+) 7 (-)             |
| <b>DOUBLE POLE SWITCHES ONLY</b> |          |       |                   |                         |
| L                                | 9        | 1     | DOWN              | 3 (+) 6 (-)             |
| M                                | R        | 1     | UP                | 3 (+) 6 (-)             |
| N                                | T        | 1     | DOWN              | 3 (+) 6 (-)             |
|                                  |          | 2     | DOWN              | 1 (+) 4 (-)             |
| P                                | V        | 1     | UP                | 1 (+) 4 (-)             |
|                                  |          | 2     | UP                | 3 (+) 6 (-)             |

**6.7 LAMP (SAME CODING FOR BOTH SELECTIONS)**

Selection 6: above terminals 1 & 4; Selection 7: above terminals 3 & 6

|              |   |        |   |             |             |
|--------------|---|--------|---|-------------|-------------|
| No lamp      | 0 |        |   |             |             |
| Neon         | 1 | 125VAC | 2 | 250VAC      |             |
| Incandescent | 4 | 3V     | 5 | 6V          |             |
| LED*         |   |        | 6 | 12V         | 7           |
|              |   |        |   | superbright | superbright |
|              |   |        |   | Green       | Red         |
| 2VDC         | A | Red    | L | Amber       | F           |
| 6VDC         | B |        | M |             | G           |
| 12VDC        | C |        | N |             | H           |
| 24VDC        | D |        | P |             | J           |

\* Consult factory for "daylight bright" LED options. Typical current draw for LED is 20ma.

**8 FLUSH BRACKET COLOR 1, PANEL SEAL**

|          |       |       |      |
|----------|-------|-------|------|
| No Seal  | Black | White | Gray |
| One Seal | B     | W     | H    |
|          | C     | Y     |      |

**9 ACTUATOR**

- 0 No Actuator
- G Contura V
- P Contura V, laser etched

**10 Lens**

0 - No Actuator    Z - No Lens    style & location: #1 / #2

| Clear | White | Amber | Green | Red | Blue |
|-------|-------|-------|-------|-----|------|
| 1     | 6     | 8     | G     | M   | T    |
| 2     | 7     | C     | H     | N   | U    |
| 3     | 8     | D     | J     | P   | V    |
| 4     | 9     | E     | K     | R   | W    |
| 5     | A     | F     | L     | S   | Y    |

Lens color for LEDs must be clear, white, or match color of LED. Green or blue lenses are not recommended with Neon lamps.

**11 ACTUATOR COLOR 1,3,5**

|             |   |        |   |        |   |     |   |
|-------------|---|--------|---|--------|---|-----|---|
| No Actuator | 0 | Black  | C | Gray   | H | Red | S |
| White       | Y | Nickel | D | Pewter | E |     |   |

**12 ACTUATOR LENS OR BODY LEGENDS 2,6**

|        |        |        |        |
|--------|--------|--------|--------|
| 11 ON  | 12 OFF | 13 I   | 14 O   |
| OFF    | ON     | O      | I      |
| 15 O O | 16 O O | 17 O I | 18 I O |
| F N    | N F    |        |        |
| F      | F      |        |        |

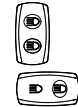

For additional legend options & codes, visit us at [www.carlingtech.com](http://www.carlingtech.com).

**13 LEGEND ORIENTATION**

- 0 No legend (used with codes 11-18 in selection 12)
- 1 Orientation 1
- 2 Orientation 2
- 3 Orientation 3
- 4 Orientation 4



**14 ACTUATOR LENS LEGEND**

00 No legend this location / no actuator (used with codes 11-18 in selection 12) Selection 14 required when switch requires two legends. If the two legends consist of one lens and one body legend, lens legend must be specified in selection 12; body legend specified in selection 14. For legend options & codes, visit us at [www.carlingtech.com](http://www.carlingtech.com).

**Notes:**

- 1 Consult factory to verify horsepower rating for your particular circuit choice.
- 2 Custom colors are available. Consult factory.
- 3 White imprinting is standard on black actuators; Black imprinting is standard on white, red and gray actuators. Custom colors are available, consult factory.
- 4 Laser Etched rocker only available with lens code Z & actuator colors black, nickel or pewter.
- 5 Additional ratings available. See V-Series Switch Accessories page.
- 6 Nickel and Pewter colors only available with laser etched actuator.
- 7 Consult factory for laser etched lens callout.



**V 1 D A S W O B - J Z E 00 - 0**

1 Series    2 Circuit    3 Rating    4 Termination Illumination Lock    5 Lamp    6 Bracket    7 Actuator    8 Lens    9 Function    10 Legend    11 Legend    12 Legend    13 Legend Orientation

**1 SERIES**  
V

**2 CIRCUIT 3**  
Terminal Connections as viewed ( ) - momentary from bottom of switch: SP - single pole - uses terminals 1, 2 & 3. **8 terminal 10 terminal** DP - double pole uses terminals 1, 2, 3, 4, 5 & 6. Terminals 7, 8, 9 & 10 for lamp circuit only.

|        |         |   |
|--------|---------|---|
| 8 - -7 | 8 - -7  | Terminals 7, 8, 9 & 10 for lamp circuit only. |
| 1 - -4 | 1 - -4  |   |
| 2 - -5 | 2 - -5  |   |
| 3 - -6 | 3 - -6  |   |
|        | 10 - -9 |   |

**Position:**

|       |              |                     |              |
|-------|--------------|---------------------|--------------|
| SP DP | 2 & 3, 5 & 6 | Connected Terminals | 1 & 2, 4 & 5 |
| 1 A   | ON           | NONE                | OFF          |
| 4 D   | ON           | NONE                | ON           |
| 6 J   | ON           | OFF                 | ON           |
| 7 K   | (ON)         | OFF                 | (ON)         |
| 8 L   | (ON)         | OFF                 | (ON)         |
| 9 N   | OFF          | NONE                | ON           |

**3 RATING 4**

|   |  |
|---|--|
| 1 | .4VA @ 28VDC Resistive                       |
| B | 15A 24V                                      |
| C | 20A 18V                                      |
| D | 20A 12V                                      |
| E | 20A 14V, 10A 14VT (circuit 1, 4, A & D only) |
| F | 10A 14V, 6A 14VT (circuit G only)            |
| M | .4VA/20A 12V                                 |
| N | .4VA/15A 24V                                 |

**4 TERMINATION / BASE STYLE**

|        |         |                             |             |
|--------|---------|-----------------------------|-------------|
| 8 term | 10 Term | Termination                 | Jumper      |
| 1      | 2       | .250 TAB (QC) no barriers   | No          |
| A      | B       | .250 TAB (QC) with barriers | No          |
| J      | K       | .250 TAB (QC) no barriers   | Yes T2 to 5 |
| 3      | 5       | Solder Lug no barriers      | No          |
| C      | D       | Solder Lug                  | No          |
| E      | 6       | Wire Leads no barriers      | No          |
| 5      | F       | Wire Leads                  | No          |

Note: Codes J & K for circuits H, G & M.

**5 ILLUMINATION & SWITCH SEALING**  
Lamp #1: above terminals 1 & 4 end of switch.; Lamp #2: above terminals 3 & 6 end of switch. Positive (+) and negative (-) symbols apply to LED lamps only

|                                  |          |       |                   |                         |
|----------------------------------|----------|-------|-------------------|-------------------------|
| Sealed                           | Unsealed | Lamps | Illumination Type | Lamp wired to Terminals |
| S                                | 0        | NONE  | -                 | -                       |
| C                                | 3        | 2     | UP                | 3 (+) 7 (-)             |
| H                                | Z        | 2     | INDEPENDENT       | 8 (+) 7 (-)             |
| <b>DOUBLE POLE SWITCHES ONLY</b> |          |       |                   |                         |
| M                                | R        | 1     | UP                | 3 (+) 6 (-)             |

**6 LOCK**  
Lock above terminals 1 & 4 end of switch.  
W low profile lock    Y 6 high profile lock

Notes:  
Consult factory to verify horsepower rating for your particular circuit choice.

- Custom colors are available. Consult factory.
- White imprinting is standard on black actuators; Black imprinting is standard on white, red and gray actuators. Custom colors are available, consult factory.
- Only available with 3 position circuits. Center OFF and special circuits only available with center position lock function.
- Additional ratings available. See V-Series Switch Accessories page.
- Located at T3-6 end of switch.
- Contura V style only.

**7 LAMP**  
Lamp above terminals 3 & 6 end of switch

|              |   |        |   |        |                   |
|--------------|---|--------|---|--------|-------------------|
| No lamp      | 0 |        |   |        |                   |
| Neon         | 1 | 125VAC | 2 | 250VAC |                   |
| Incandescent | 4 | 3V     | 5 | 6V     |                   |
| LED*         |   |        |   |        |                   |
|              |   | Red    |   | Amber  | 6 12V superbright |
|              |   |        |   |        | 7 18V superbright |
|              |   |        |   |        | 8 24V superbright |
| 2VDC         | A |        | L |        | F Green           |
| 6VDC         | B |        | M |        | G                 |
| 12VDC        | C |        | N |        | H                 |
| 24VDC        | D |        | P |        | J                 |

\* Consult factory for "daylight bright" LED options. Typical current draw for LED is 20ma.

**8 FLUSH BRACKET COLOR 1, PANEL SEAL**

|          |       |       |      |
|----------|-------|-------|------|
| No Seal  | Black | White | Gray |
| One Seal | B     | W     | G    |
|          | C     | Y     | H    |

**9 HARD SURFACE ACTUATOR**  
CONTURA IV:  
Orientation Black Gray Red White  
Left J K L M  
Right N P R S



CONTURA V:  
Orientation Black Gray Red White  
U V W Y



Actuator orientation above terminals: 3,6 1,4

**10 LENS 5**  
Z - No Lens  
Clear White Amber Green Red Blue  
A B C D E F bar lens  
G H J K L M oval lens

Lens color for LEDs must be clear, white, or match color of LED. Green or blue lenses are not recommended with Neon lamps.

**11 ACTUATOR LOCK FUNCTION AND COLOR 1**

|                |    |      |           |          |
|----------------|----|------|-----------|----------|
| Lock Color     | Up | Down | Up & Down | Center 3 |
| Match Actuator | A  | H    | R         | 1        |
| Black          | B  | J    | S         | 2        |
| White          | C  | K    | T         | 3        |
| Red            | D  | L    | V         | 4        |
| Safety Orange  | E  | M    | W         | 5        |
| Gray           | F  | G    | N         | 6        |

**12 ACTUATOR LENS OR BODY LEGEND 2**  
00 - No Legend

|      |      |      |      |
|------|------|------|------|
| 21   | 22   | 23   | 24   |
| OFF  | ON   | O    | I    |
| 25 O | 26 O | 27 O | 28 I |
| F    | N    |      |      |



For additional legend options & codes, visit us at [www.carlingtech.com](http://www.carlingtech.com).

**13 LEGEND ORIENTATION**

|   |               |  |  |  |  |
|---|---------------|--|--|--|--|
| 0 | No legend     |  |  |  |  |
| 1 | Orientation 1 |  |  |  |  |
| 2 | Orientation 2 |  |  |  |  |
| 3 | Orientation 3 |  |  |  |  |
| 4 | Orientation 4 |  |  |  |  |

1    2    3    4

**V 1 D B G N T B - H A 7 C B - AC 1 00**

1 Series    2 Circuit    3 Rating    4 Termination Illumination Lamp    5 Lamp    6 Bracket    7 Actuator    8 Lens    9 Lens    10 Color    11 Insert    12 Color    13 Actuator    14 Legend    15 Actuator    16 Legend

**1 SERIES**

V

**2 CIRCUIT**

Terminal Connections as viewed ( ) - momentary from bottom of switch: SP - single pole - uses terminals 1, 2 & 3. **8 terminal 10 terminal** DP - double pole uses terminals 1, 2, 3, 4, 5 & 6. Terminals 7, 8, 9 & 10 for lamp circuit only.

|        |         |  |
|--------|---------|--|
| 8 - -7 | 8 - -7  |  |
| 1 - -4 | 1 - -4  |  |
| 2 - -5 | 2 - -5  |  |
| 3 - -6 | 3 - -6  |  |
|        | 10 - -9 |  |

|                  |              |                     |              |
|------------------|--------------|---------------------|--------------|
| <b>Position:</b> | <b>1</b>     | <b>2</b>            | <b>3</b>     |
| SP DP            | 2 & 3, 5 & 6 | Connected Terminals | 1 & 2, 4 & 5 |
| 1 A              | ON           | NONE                | OFF          |
| 2 B              | (ON)         | NONE                | OFF          |
| 3 C              | (ON)         | NONE                | (OFF)        |
| 4 D              | ON           | NONE                | ON           |
| 5 F              | ON           | NONE                | (ON)         |
| 6 J              | ON           | OFF                 | ON           |
| 7 K              | ON           | OFF                 | (ON)         |
| 8 L              | (ON)         | OFF                 | (ON)         |

**SPECIAL CIRCUITS**

|    |                |              |       |
|----|----------------|--------------|-------|
| H* | 2 & 3          | 2 & 3, 5 & 4 | 5 & 4 |
| G* | 2 & 3, 5 & 6   | 2 & 3        | OFF   |
| S* | 2 & 3, 5 & 6   | 2 & 3        | 1 & 2 |
| M* | (2 & 3, 5 & 6) | 2 & 3        | OFF   |
| R* | (2 & 3, 5 & 6) | 2 & 3        | 2 & 1 |
| E* | 5 & 6          | 5 & 3        | 5 & 1 |

\*Jumper between terminals 2 & 5 for circuits H, G, M, R & S are specified in selection 4. External jumper between terminals 2 & 4 for circuit E are provided by customer. Circuit E may be used for SP OFF-ON-ON circuit.

**3 RATING 3**

- 1 .4VA @ 28VDC Resistive
- B 15A 24V
- C 20A 18V
- D 20A 12V
- E 20A 14V, 10A 14VT (circuit 1, 4, A & D only)
- F 10A 14V, 6A 14VT (circuit G only)
- M .4VA/20A 12V
- N .4VA/15A 24V

**4 TERMINATION / BASE STYLE**

|        |         |                            |             |
|--------|---------|----------------------------|-------------|
| 8 term | 10 Term | Termination                | Jumper      |
| 1      | 2       | 250 TAB (QC) no barriers   | No          |
| A      | B       | 250 TAB (QC) with barriers | No          |
| J      | K       | 250 TAB (QC) no barriers   | Yes T2 to 5 |
| 3      | 5       | Solder Lug no barriers     | No          |
| C      | D       | Solder Lug                 | No          |
| E      | 6       | Wire Leads no barriers     | No          |
| 5      | F       | Wire Leads                 | No          |

Note: Codes J & K for circuits H, G & M.

**5 ILLUMINATION & SWITCH SEALING**

Lamp #1 above terminals 1 & 4 end of switch.; Lamp #2 above terminals 3 & 6 end of switch. Positive (+) and negative (-) symbols apply to LED lamps only

|                                  |          |       |                   |                         |
|----------------------------------|----------|-------|-------------------|-------------------------|
| Sealed                           | Unsealed | Lamps | Illumination Type | Lamp wired to Terminals |
| S                                | 0        | NONE  | -                 | -                       |
| A                                | 1        | 1     | INDEPENDENT       | 8 (+) 7 (-)             |
| B                                | 2        | 1     | DOWN              | 3 (+) 7 (-)             |
| C                                | 3        | 2     | UP                | 3 (+) 7 (-)             |
| D                                | 4        | 1     | DOWN              | 3 (+) 7 (-)             |
| E                                | 5        | 2     | DOWN              | 1 (+) 7 (-)             |
| F                                | 6        | 1     | UP                | 1 (+) 7 (-)             |
| G                                | 7        | 2     | UP                | 3 (+) 7 (-)             |
| H                                | Z        | 1     | INDEPENDENT       | 8 (+) 7 (-)             |
| U                                | Y        | 2     | INDEPENDENT       | 8 (+) 7 (-)             |
|                                  |          | 2     | INDEPENDENT       | 10 (+) 9 (-)            |
| <b>SINGLE POLE SWITCHES ONLY</b> |          |       |                   |                         |
| J                                | 8        | 1     | DOWN              | 3 (+) 8 (-)             |
|                                  |          | 2     | INDEPENDENT       | 6 (+) 7 (-)             |
| K                                | W        | 1     | INDEPENDENT       | 8 (+) 7 (-)             |
|                                  |          | 2     | INDEPENDENT       | 6 (+) 7 (-)             |
| <b>DOUBLE POLE SWITCHES ONLY</b> |          |       |                   |                         |
| L                                | 9        | 1     | DOWN              | 3 (+) 6 (-)             |
| M                                | R        | 1     | UP                | 3 (+) 6 (-)             |
| N                                | T        | 1     | DOWN              | 3 (+) 6 (-)             |
|                                  |          | 2     | DOWN              | 1 (+) 4 (-)             |
| P                                | V        | 1     | UP                | 1 (+) 4 (-)             |
|                                  |          | 2     | UP                | 3 (+) 6 (-)             |

**6,7 LAMP**

Lamp above terminals 3 & 6 end of switch



|              |   |        |   |        |                 |
|--------------|---|--------|---|--------|-----------------|
| No lamp      | 0 |        |   |        |                 |
| Neon         | 1 | 125VAC | 2 | 250VAC |                 |
| Incandescent | 4 | 3V     | 5 | 6V     | 6               |
| LED*         |   |        |   |        | 12V superbright |
|              |   | Red    |   | Amber  | 7               |
|              |   |        |   | Green  | 18V superbright |
| 2VDC         | A |        | L |        | Red             |
| 6VDC         | B |        | M |        | R               |
| 12VDC        | C |        | N |        | S               |
| 24VDC        | D |        | P |        | T               |
|              |   |        |   |        | V               |

\* Consult factory for "daylight bright" LED options. Typical current draw for LED is 20ma.

**8 FLUSH BRACKET COLOR 1, PANEL SEAL**

|          |       |       |      |
|----------|-------|-------|------|
|          | Black | White | Gray |
| No Seal  | B     | W     | G    |
| One Seal | C     | Y     | H    |

**9 ACTUATOR**

0 No Actuator    H High Insert     L Low Insert 

**10,11 LENS**

|                 |             |       |       |     |      |
|-----------------|-------------|-------|-------|-----|------|
| 0 - No Actuator | Z - No Lens |       |       |     |      |
| Clear           | White       | Amber | Green | Red | Blue |
| -               | 7           | C     | H     | N   | U    |
| 3               | -           | D     | J     | P   | V    |
| 4               | -           | E     | K     | R   | W    |
| -               | A           | F     | L     | S   | Y    |

Bar Lens Translucent  
Bar Lens Transparent  
Oval Lens Transparent  
Oval Lens Translucent

Lens color for LEDs must be clear, white, or match color of LED. Green or blue lenses are not recommended with Neon lamps.



**12 ACTUATOR COLOR**

|   |       |   |      |   |     |   |       |
|---|-------|---|------|---|-----|---|-------|
| C | Black | H | Gray | S | Red | Y | White |
|---|-------|---|------|---|-----|---|-------|

**13 INSERT COLOR**





|   |                      |   |                      |
|---|----------------------|---|----------------------|
| B | Black                | N | Bright Nickel Plated |
| C | Bright Chrome Plated | S | Satin Chrome Plated  |
| D | Satin Chrome Painted | T | Satin Nickel Plated  |
|   |                      | W | White                |

**14 ACTUATOR LENS OR BODY LEGENDS 2**

00 - No Legend this location/No actuator   
 11 ON 12 OFF 13 I 14 O   
 OFF ON O I  
 15 O O 16 O O 17 O I 18 I O   
 F N N F  
 F F

For additional legend options & codes, visit us at [www.carlingtech.com](http://www.carlingtech.com).

**15 LEGEND ORIENTATION**

0 No legend (used with codes 11-18 in selection 12)  
 1 Orientation 1   
 2 Orientation 2   
 3 Orientation 3   
 4 Orientation 4 

**16 ACTUATOR LENS LEGEND**

00 No legend this location / no actuator (used with codes 11-18 in selection 12) Selection 14 required when switch requires two legends. If the two legends consist of one lens and one body legend, lens legend must be specified in selection 12; body legend specified in selection 14.  
 For legend options & codes, visit us at [www.carlingtech.com](http://www.carlingtech.com).

**Notes:**

- Consult factory to verify horsepower rating for your particular circuit choice.
- 1 Custom colors are available. Consult factory.
- 2 White imprinting is standard on black actuators. Black imprinting is standard on white, red and gray actuators. Custom colors are available, consult factory.
- 3 Additional ratings available. See V-Series Switch Accessories page.

|          |           |          |               |                |        |        |           |            |         |          |           |           |                         |             |    |
|----------|-----------|----------|---------------|----------------|--------|--------|-----------|------------|---------|----------|-----------|-----------|-------------------------|-------------|----|
| V        | 1         | D        | A             | B              | T      | O      | B         | -          | Z       | R        | C         | 00        | -                       | 0           | 00 |
| 1 Series | 2 Circuit | 3 Rating | 4 Termination | 5 Illumination | 6 Lamp | 7 Lamp | 8 Bracket | 9 Actuator | 10 Lens | 11 Color | 12 Legend | 13 Legend | 14 Actuator Orientation | Lens Legend |    |

**1 SERIES**  
V

**2 CIRCUIT**

Terminal Connections as viewed ( ) - momentary from bottom of switch: SP - single pole - uses terminals 1, 2 & 3. DP - double pole uses terminals 1, 2, 3, 4, 5 & 6. **8 terminal 10 terminal** Terminals 7, 8, 9 & 10 for lamp circuit only.

|         |        |
|---------|--------|
| 8 - -7  | 8 - -7 |
| 1 - -4  | 1 - -4 |
| 2 - -5  | 2 - -5 |
| 3 - -6  | 3 - -6 |
| 10 - -9 |        |

|                  |              |           |              |
|------------------|--------------|-----------|--------------|
| <b>Position:</b> | <b>1</b>     | <b>2</b>  | <b>3</b>     |
| SP DP            | 2 & 3, 5 & 6 | Connected | 1 & 2, 4 & 5 |
| 1 A              | ON           | NONE      | OFF          |
| 2 B              | (ON)         | NONE      | OFF          |
| 3 C              | ON           | NONE      | (OFF)        |
| 4 D              | ON           | NONE      | ON           |
| 5 F              | ON           | NONE      | (ON)         |
| 6 J              | ON           | OFF       | ON           |
| 7 K              | ON           | OFF       | (ON)         |
| 8 L              | (ON)         | OFF       | (ON)         |

**SPECIAL CIRCUITS**

|    |                |              |       |
|----|----------------|--------------|-------|
| H* | 2 & 3          | 2 & 3, 5 & 4 | 5 & 4 |
| G* | 2 & 3, 5 & 6   | 2 & 3        | OFF   |
| S* | 2 & 3, 5 & 6   | 2 & 3        | 1 & 2 |
| M* | (2 & 3, 5 & 6) | 2 & 3        | OFF   |
| R* | (2 & 3, 5 & 6) | 2 & 3        | 2 & 1 |
| E* | 5 & 6          | 5 & 3        | 5 & 1 |

\*Jumper between terminals 2 & 5 for circuits H,G,M,R & S are specified in selection 4. External jumper between terminals 2 & 4 for circuit E are provided by customer. Circuit E may be used for SP OFF-ON-ON circuit.

**3 RATING 4**

|   |  |
|---|--|
| 1 | .4VA @ 28VDC Resistive                       |
| B | 15A 24V                                      |
| C | 20A 18V                                      |
| D | 20A 12V                                      |
| E | 20A 14V, 10A 14VT (circuit 1, 4, A & D only) |
| F | 10A 14V, 6A 14VT (circuit G only)            |
| M | .4VA/20A 12V                                 |
| N | .4VA/15A 24V                                 |

**4 TERMINATION / BASE STYLE**

|        |         |                             |             |
|--------|---------|-----------------------------|-------------|
| 8 term | 10 Term | Termination                 | Jumper      |
| 1      | 2       | .250 TAB (QC) no barriers   | No          |
| A      | B       | .250 TAB (QC) with barriers | No          |
| J      | K       | .250 TAB (QC) no barriers   | Yes T2 to 5 |
| 3      | 5       | Solder Lug no barriers      | No          |
| C      | D       | Solder Lug                  | No          |
| 5      | 6       | Wire Leads no barriers      | No          |
| E      | F       | Wire Leads                  | No          |

Note: Codes J & K for circuits H, G & M.

**5 ILLUMINATION & SWITCH SEALING**

Lamp #1: above terminals 1 & 4 end of switch.; Lamp #2 above terminals 3 & 6 end of switch. Positive (+) and negative (-) symbols apply to LED lamps only

| Sealed                           | Unsealed | Lamps | Illumination Type | Lamp wired to Terminals |
|----------------------------------|----------|-------|-------------------|-------------------------|
|                                  | 0        | NONE  | -                 | -                       |
| A                                | 1        | 1     | INDEPENDENT       | 8 (+) 7 (-)             |
| B                                | 2        | 1     | DOWN              | 3 (+) 7 (-)             |
| C                                | 3        | 2     | UP                | 3 (+) 7 (-)             |
| D                                | 4        | 1     | DOWN              | 3 (+) 7 (-)             |
|                                  |          | 2     | DOWN              | 1 (+) 7 (-)             |
| E                                | 5        | 1     | UP                | 1 (+) 7 (-)             |
|                                  |          | 2     | UP                | 3 (+) 7 (-)             |
| F                                | 6        | 1     | INDEPENDENT       | 8 (+) 7 (-)             |
|                                  |          | 2     | UP                | 3 (+) 6 (-)             |
| G                                | 7        | 1     | INDEPENDENT       | 8 (+) 7 (-)             |
|                                  |          | 2     | UP                | 3 (+) 7 (-)             |
| H                                | Z        | 2     | INDEPENDENT       | 8 (+) 7 (-)             |
| U                                | Y        | 1     | INDEPENDENT       | 8 (+) 7 (-)             |
|                                  |          | 2     | INDEPENDENT       | 10 (+) 9 (-)            |
| <b>SINGLE POLE SWITCHES ONLY</b> |          |       |                   |                         |
| J                                | 8        | 1     | DOWN              | 3 (+) 8 (-)             |
|                                  |          | 2     | INDEPENDENT       | 6 (+) 7 (-)             |
| K                                | W        | 1     | INDEPENDENT       | 8 (+) 7 (-)             |
|                                  |          | 2     | INDEPENDENT       | 6 (+) 7 (-)             |
| <b>DOUBLE POLE SWITCHES ONLY</b> |          |       |                   |                         |
| L                                | 9        | 1     | DOWN              | 3 (+) 6 (-)             |
| M                                | R        | 1     | UP                | 3 (+) 6 (-)             |
| N                                | T        | 1     | DOWN              | 3 (+) 6 (-)             |
|                                  |          | 2     | DOWN              | 1 (+) 4 (-)             |
| P                                | V        | 1     | UP                | 1 (+) 4 (-)             |
|                                  |          | 2     | UP                | 3 (+) 6 (-)             |

**6,7 LAMP (same coding for both selections)**

Selection 6: above terminals 1 & 4; Selection 7: above terminals 3 & 6

|              |   |        |          |             |             |       |
|--------------|---|--------|----------|-------------|-------------|-------|
| No lamp      | 0 | 125VAC | 2 250VAC | 6 12V       | 7 18V       | 8 24V |
| Neon         | 1 | 4 3V   | 5 6V     | superbright | superbright |       |
| Incandescent | 4 |        |          | Green       | Red         |       |
| LED*         |   |        |          | F           | R           |       |
|              |   | Red    | Amber    | Green       | Red         |       |
| 2VDC         | A | L      | F        | R           |             |       |
| 6VDC         | B | M      | G        | S           |             |       |
| 12VDC        | C | N      | H        | T           |             |       |
| 24VDC        | D | P      | J        | V           |             |       |

\* Consult factory for "daylight bright" LED options. Typical current draw for LED is 20ma.

**8 FLUSH BRACKET COLOR 1, PANEL SEAL**

|          |       |       |      |
|----------|-------|-------|------|
| No Seal  | Black | White | Gray |
| One Seal | B     | W     | G    |
|          | C     | Y     | H    |

**9 ACTUATOR**

0 No Actuator  
Z Contura VII  
Actuator orientation above terminals:



**10 LENS**

Lens color for LEDs must be clear, white, or match color of LED. Green or blue lenses are not recommended with Neon lamps.

|                 |             |       |     |      |                       |
|-----------------|-------------|-------|-----|------|-----------------------|
| 0 - No Actuator | Z - No Lens |       |     |      |                       |
| White           | Amber       | Green | Red | Blue | Lens style & location |
| 6               | B           | G     | M   | T    |                       |
| 7               | C           | H     | N   | U    |                       |
| 8               | D           | J     | P   | V    |                       |
| 9               | E           | K     | R   | W    |                       |
| A               | F           | L     | S   | Y    |                       |
| 1               | 2           | 3     | 4   | 5    |                       |

**11 ACTUATOR COLOR / THUMB PRINT COLOR 1**

|   |                   |   |             |
|---|-------------------|---|-------------|
| O | N/A - No Actuator | C | Black/Black |
| H | Grey/Black        | S | Red/Black   |
| Y | White/Black       |   |             |

**14 ACTUATOR LENS OR BODY LEGENDS 2**

|        |        |        |        |
|--------|--------|--------|--------|
| 11 ON  | 12 OFF | 13 I   | 14 O   |
| OFF    | ON     | O      | I      |
| 15 O O | 16 O O | 17 O I | 18 I O |
| F N    | N F    |        |        |
| F      | F      |        |        |

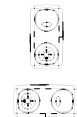

For additional legend options & codes, visit us at [www.carlingtech.com](http://www.carlingtech.com).

**13 LEGEND ORIENTATION**

0 No legend (used with codes 11-18 in selection 12)  
1 Orientation 1  
2 Orientation 2  
3 Orientation 3  
4 Orientation 4

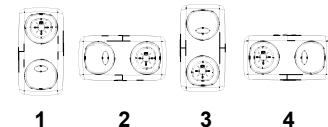

**14 ACTUATOR LENS LEGEND**

00 No legend this location / no actuator (used with codes 11-18 in selection 12) Selection 14 required when switch requires two legends. If the two legends consist of one lens and one body legend, lens legend must be specified in selection 12; body legend specified in selection 14. For legend options & codes, visit us at [www.carlingtech.com](http://www.carlingtech.com).

**Notes:**

- 1 Consult factory to verify horsepower rating for your particular circuit choice.
- 2 Custom colors are available. Consult factory.
- 3 White imprinting is standard on black actuators. Black imprinting is standard on white, red and gray actuators. Custom colors are available, consult factory.
- 4 Additional ratings available. See V-Series Switch Accessories page.
- 5 Legends available for lighted oval lens version only

**V 1 D A B 6 0 1 - 6 P Z 00 - 0 00**

1 Series    2 Circuit    3 Rating    4 Termination Illumination    5 Lamp    6 Lamp    7 Lamp    8 Bracket    9 Actuator    10 Lens    11 Lens    12 Legend    13 Legend Orientation    14 Actuator Lens Legend

**1 SERIES**  
V

**2 CIRCUIT**  
Terminal Connections as viewed ( ) - momentary from bottom of switch: SP - single pole - uses terminals 1, 2 & 3. **8 terminal 10 terminal** DP - double pole uses terminals 1, 2, 3, 4, 5 & 6. Terminals 7, 8, 9 & 10 for lamp circuit only.

8 - -7    8 - -7  
1 - -4    1 - -4  
2 - -5    2 - -5  
3 - -6    3 - -6  
10 - -9

**Position:**

| SP DP | 1    | 2    | 3     |
|-------|------|------|-------|
| 1     | ON   | NONE | OFF   |
| 2     | (ON) | NONE | OFF   |
| 3     | ON   | NONE | (OFF) |
| 4     | ON   | NONE | ON    |
| 5     | ON   | NONE | (ON)  |
| 6     | ON   | OFF  | ON    |
| 7     | ON   | OFF  | (ON)  |
| 8     | (ON) | OFF  | (ON)  |

**SPECIAL CIRCUITS**

|    | 2 & 3          | 2 & 3, 5 & 6 | 2 & 3, 5 & 4 | 5 & 4 |
|----|----------------|--------------|--------------|-------|
| H* | 2 & 3          | 2 & 3, 5 & 6 | 2 & 3, 5 & 4 | 5 & 4 |
| G* | (2 & 3, 5 & 6) | 2 & 3, 5 & 6 | 2 & 3, 5 & 4 | OFF   |
| M* | (2 & 3, 5 & 6) | 2 & 3, 5 & 6 | 2 & 3, 5 & 4 | OFF   |
| R* | (2 & 3, 5 & 6) | 2 & 3, 5 & 6 | 2 & 3, 5 & 4 | OFF   |
| E* | 5 & 6          | 5 & 6        | 5 & 3        | 2 & 1 |

\*Jumper between terminals 2 & 5 for circuits H, G, M, R & S are specified in selection 4. External jumper between terminals 2 & 4 for circuit E are provided by customer. Circuit E may be used for SP OFF-ON-ON circuit.

**3 RATING 4**

|   |  |
|---|--|
| 1 | .4VA @ 28VDC Resistive                       |
| B | 15A 24V                                      |
| C | 20A 18V                                      |
| D | 20A 12V                                      |
| E | 20A 14V, 10A 14VT (circuit 1, 4, A & D only) |
| F | 10A 14V, 6A 14VT (circuit G only)            |
| M | .4VA/20A 12V                                 |
| N | .4VA/15A 24V                                 |

**4 TERMINATION / BASE STYLE**

| 8 term | 10 Term | Termination                 | Jumper      |
|--------|---------|-----------------------------|-------------|
| 1      | 2       | .250 TAB (QC) no barriers   | No          |
| A      | B       | .250 TAB (QC) with barriers | No          |
| J      | K       | .250 TAB (QC) no barriers   | Yes T2 to 5 |
| 3      | 5       | Solder Lug no barriers      | No          |
| C      | D       | Solder Lug                  | No          |
| 5      | 6       | Wire Leads no barriers      | No          |
| E      | F       | Wire Leads                  | No          |

Note: Codes J & K for circuits H, G & M.

**5 ILLUMINATION & SWITCH SEALING**  
Lamp #1: above terminals 1 & 4 end of switch.; Lamp #2 above terminals 3 & 6 end of switch. Positive (+) and negative (-) symbols apply to LED lamps only

| Sealed                           | Unsealed | Lamps | Illumination Type | Lamp wired to Terminals |
|----------------------------------|----------|-------|-------------------|-------------------------|
| S                                | 0        | NONE  | -                 | -                       |
| A                                | 1        | 1     | INDEPENDENT       | 8 (+) 7 (-)             |
| B                                | 2        | 1     | DOWN              | 3 (+) 7 (-)             |
| C                                | 3        | 2     | UP                | 3 (+) 7 (-)             |
| D                                | 4        | 1     | DOWN              | 3 (+) 7 (-)             |
| E                                | 5        | 2     | DOWN              | 1 (+) 7 (-)             |
| F                                | 6        | 1     | UP                | 1 (+) 7 (-)             |
| G                                | 7        | 2     | UP                | 3 (+) 7 (-)             |
| H                                | Z        | 2     | INDEPENDENT       | 8 (+) 7 (-)             |
| U                                | Y        | 1     | INDEPENDENT       | 8 (+) 7 (-)             |
|                                  |          | 2     | INDEPENDENT       | 10 (+) 9 (-)            |
| <b>SINGLE POLE SWITCHES ONLY</b> |          |       |                   |                         |
| J                                | 8        | 1     | DOWN              | 3 (+) 8 (-)             |
|                                  |          | 2     | INDEPENDENT       | 6 (+) 7 (-)             |
| K                                | W        | 1     | INDEPENDENT       | 8 (+) 7 (-)             |
|                                  |          | 2     | INDEPENDENT       | 6 (+) 7 (-)             |
| <b>DOUBLE POLE SWITCHES ONLY</b> |          |       |                   |                         |
| L                                | 9        | 1     | DOWN              | 3 (+) 6 (-)             |
| M                                | R        | 1     | UP                | 3 (+) 6 (-)             |
| N                                | T        | 1     | DOWN              | 3 (+) 6 (-)             |
|                                  |          | 2     | DOWN              | 1 (+) 4 (-)             |
| P                                | V        | 1     | UP                | 1 (+) 4 (-)             |
|                                  |          | 2     | UP                | 3 (+) 6 (-)             |

**6,7 LAMP (same coding for both selections)**  
Selection 6: above terminals 1 & 4; Selection 7: above terminals 3 & 6

|              |   |        |   |        |                         |
|--------------|---|--------|---|--------|-------------------------|
| No lamp      | 0 |        |   |        |                         |
| Neon         | 1 | 125VAC | 2 | 250VAC |                         |
| Incandescent | 4 | 3V     | 5 | 6V     |                         |
| LED*         |   | Red    |   | Amber  | 6 12V superbright Green |
|              |   | A      |   | L      | 7 18V superbright Red   |
| 2VDC         |   | B      |   | M      | F                       |
| 6VDC         |   | C      |   | N      | G                       |
| 12VDC        |   | D      |   | P      | H                       |
| 24VDC        |   |        |   |        | I                       |
|              |   |        |   |        | J                       |
|              |   |        |   |        | K                       |
|              |   |        |   |        | L                       |
|              |   |        |   |        | M                       |
|              |   |        |   |        | N                       |
|              |   |        |   |        | O                       |
|              |   |        |   |        | P                       |
|              |   |        |   |        | Q                       |
|              |   |        |   |        | R                       |
|              |   |        |   |        | S                       |
|              |   |        |   |        | T                       |
|              |   |        |   |        | U                       |
|              |   |        |   |        | V                       |

\*Consult factory for "daylight bright" LED. Typical current draw for LED is 20ma

**8 BRACKET COLOR 1, PANEL SEAL (EXTERNAL FOAM GASKET)**  
X & XI with Flush Bracket    X, XI, XII with Raised Bracket

| # of gaskets | 1 | 2 | 0 | 1 |
|--------------|---|---|---|---|
| Black        | B | C | D | 1 |
| White        | W | Y | Z | 2 |
| Gray         | G | H | J | 3 |

**9 ACTUATOR**

|             |   |       |      |       |     |
|-------------|---|-------|------|-------|-----|
| No Actuator | 0 |       |      |       |     |
|             |   | Black | Gray | White | Red |
| Contura X   | 1 |       | 2    | 3     | 4   |
| Contura XI  | 6 |       | 7    | 8     | 9   |
| Contura XII | J |       | K    | N     | M   |

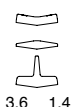
Actuator orientation above terminals: 

**10 LENS - ABOVE LAMP #1 TERMINALS 1,4**  
**11 LENS - ABOVE LAMP #2 TERMINALS 3,6**

| 0 - No Actuator | Z - No Lens | Clear | White | Amber | Green | Red | Blue              | Lens Style                       |
|-----------------|-------------|-------|-------|-------|-------|-----|-------------------|----------------------------------|
| 3               | 8           | D     | J     | P     | V     | W   | Bar               |                                  |
| 4               | 9           | E     | K     | R     | V     | W   | One piece Square  |                                  |
| 5               | A           | F     | L     | S     | Y     |     | Two piece Square* | (With clear top protective lens) |
| 2               | 7           | C     | H     | N     | U     |     | Two piece Square* | (With smoke top protective lens) |
| 1               | 6           | B     | G     | M     | T     |     | Two piece Square* | (With white top protective lens) |

\* All bottom lenses are molded of opaque material. Consult factory for other lens colors. Lens color for LEDs must be clear, white, or match color of LED. Green or blue lenses are not recommended with Neon lamps.

**12 ACTUATOR LENS OR BODY LEGEND 2**

|    |                                       |
|----|---------------------------------------|
| 00 | No Legend this location / No actuator |
| 11 | ON                                    |
| 12 | OFF                                   |
| 13 | I                                     |
| 14 | O                                     |
| 15 | O O                                   |
| 16 | O O                                   |
| 17 | O I                                   |
| 18 | I O                                   |
| 21 | OFF                                   |
| 22 | ON                                    |
| 23 | O                                     |
| 24 | I                                     |
| 25 | O                                     |
| 26 | O                                     |
| 27 | O                                     |
| 28 | I                                     |

For additional legend options & codes, visit us at [www.carlingtech.com](http://www.carlingtech.com).

**13 LEGEND ORIENTATION 3**

|   |   |
|---|---|
| 0 | No legend (used with codes 11-18 in selection 12) |
| 1 | Orientation 1                                     |
| 2 | Orientation 2                                     |
| 3 | Orientation 3                                     |
| 4 | Orientation 4                                     |

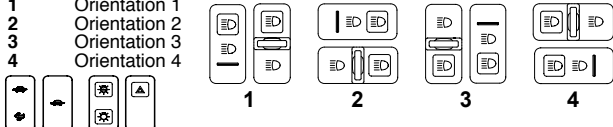

**14 ACTUATOR LENS LEGEND**  
00 No legend this location / no actuator (used with codes 11-18 in selection 12) Selection 14 required when switch requires two legends. If the two legends consist of one lens and one body legend, lens legend must be specified in selection 12; body legend specified in selection 14. For legend options & codes, visit us at [www.carlingtech.com](http://www.carlingtech.com).

- Notes:
- Consult factory to verify horsepower rating for your particular circuit choice.
  - Custom colors are available. Consult factory.
  - White imprinting is standard on black actuators; Black imprinting is standard on white, red & gray actuators. Custom colors are available, consult factory.
  - With 2 square lenses, use selection 12 for lens above lamp 1, & selection 14 for lens above lamp 2.
  - Additional ratings available. See V-Series Switch Accessories page.
  - Not available with Contura XI rockers.

**V 1 D A S W O 1 - 1 P B 00 - 0**

1 Series    2 Circuit    3 Rating    4 Termination    5 Illumination    6 Lock    7 Lamp    8 Bracket    9 Actuator    10 Lens    11 Function    12 Legend    13 Legend Orientation

**1 SERIES**  
V

**2 CIRCUIT**

Terminal Connections as viewed ( ) - momentary from bottom of switch: SP - single pole - uses terminals 1, 2 & 3.  
**8 terminal 10 terminal** DP - double pole uses terminals 1, 2, 3, 4, 5 & 6.  
 8 - -7    8 - -7    Terminals 7, 8, 9 & 10 for lamp circuit only.  
 1 - -4    1 - -4  
 2 - -5    2 - -5  
 3 - -6    3 - -6  
 10 - -9

| Position: | 1            | 2                   | 3            |
|-----------|--------------|---------------------|--------------|
| SP DP     | 2 & 3, 5 & 6 | Connected Terminals | 1 & 2, 4 & 5 |
| 1 A       | ON           | NONE                | OFF          |
| 4 D       | ON           | NONE                | ON           |
| 6 J       | OFF          | OFF                 | ON           |
| 9 N       | OFF          | NONE                | ON           |

**SPECIAL CIRCUITS**

|    | 2 & 3        | 2 & 3, 5 & 4 | 5 & 4 |
|----|--------------|--------------|-------|
| H* | 2 & 3        | 2 & 3, 5 & 4 | 5 & 4 |
| G* | 2 & 3, 5 & 6 | 2 & 3        | OFF   |
| S* | 2 & 3, 5 & 6 | 2 & 3        | 1 & 2 |
| E* | 5 & 6        | 5 & 3        | 5 & 1 |

\*Jumper between terminals 2 & 5 for circuits H,G,M,R & S are specified in selection 4. External jumper between terminals 2 & 4 for circuit E are provided by customer. Circuit E may be used for SP OFF-ON-ON circuit.

**3 RATING 4**

|   |  |
|---|--|
| 1 | .4VA @ 28VDC Resistive                       |
| B | 15A 24V                                      |
| C | 20A 18V                                      |
| D | 20A 12V                                      |
| E | 20A 14V, 10A 14VT (circuit 1, 4, A & D only) |
| F | 10A 14V, 6A 14VT (circuit G only)            |
| M | .4VA/20A 12V                                 |
| N | .4VA/15A 24V                                 |

**4 TERMINATION / BASE STYLE**

| 8 term | 10 Term | Termination                 | Jumper      |
|--------|---------|-----------------------------|-------------|
| 1      | 2       | .250 TAB (QC) no barriers   | No          |
| A      | B       | .250 TAB (QC) with barriers | No          |
| J      | K       | .250 TAB (QC) no barriers   | Yes T2 to 5 |
| 3      | 5       | Solder Lug no barriers      | No          |
| C      | D       | Solder Lug                  | No          |
| 5      | 6       | Wire Leads no barriers      | No          |
| E      | F       | Wire Leads                  | No          |

Note: Codes J & K for circuits H, G & M.

**5 ILLUMINATION & SWITCH SEALING**

Lamp #1 :above terminals 1 & 4 end of switch.; Lamp #2 above terminals 3 & 6 end of switch. Positive (+) and negative (-) symbols apply to LED lamps only

| Sealed | Unsealed | Lamps | Illumination Type | Lamp wired to Terminals |
|--------|----------|-------|-------------------|-------------------------|
| S      | 0        | NONE  | -                 | -                       |
| C      | 3        | 2     | UP                | 3 (+) 7 (-)             |
| H      | Z        | 2     | INDEPENDENT       | 8 (+) 7 (-)             |

**DOUBLE POLE SWITCHES ONLY**

|   |   |   |    |             |
|---|---|---|----|-------------|
| M | R | 1 | UP | 3 (+) 6 (-) |
|---|---|---|----|-------------|

**6 LOCK**

Lock above terminals 1 & 4 end of switch.  
**W** Lock

**Notes:**

- Consult factory to verify horsepower rating for your particular circuit choice.
- 1 Custom colors are available. Consult factory.
- 2 White imprinting is standard on black actuators; Black imprinting is standard on white, red and gray actuators; Custom colors are available, consult factory.
- 3 Located over T1-4 end of switch.
- 4 Additional ratings available. See V-Series Switch Accessories page.
- 5 Located over T3-6 end of switch.

**6,7 LAMP (same coding for both selections)**

Selection 6: above terminals 1 & 4; Selection 7: above terminals 3 & 6

|                   |          |          |       |             |             |
|-------------------|----------|----------|-------|-------------|-------------|
| No lamp           | 0        |          |       |             |             |
| Neon              | 1 125VAC | 2 250VAC |       |             |             |
| Incandescent LED* | 4 3V     | 5 6V     | 6 12V | 7 18V       | 8 24V       |
|                   | Red      | Amber    | Green | superbright | superbright |
| 2VDC              | A        | L        | F     | R           |             |
| 6VDC              | B        | M        | G     | S           |             |
| 12VDC             | C        | N        | H     | T           |             |
| 24VDC             | D        | P        | J     | V           |             |

\* Consult factory for "daylight bright" LED options. Typical current draw for LED is 20ma.

**8 FLUSH BRACKET COLOR 1, PANEL SEAL**

|            | Black | White | Gray |
|------------|-------|-------|------|
| No Gasket  | 1     | 2     | 3    |
| One Gasket | 4     | 5     | 6    |

**9 HARD SURFACE ACTUATOR**

| Contura X | Black | Gray | Red | White |
|-----------|-------|------|-----|-------|
|           | 1     | 2    | 3   | 4     |



Actuator orientation above terminals: 3,6 1,4

**10 LENS - ABOVE LAMP #2 TERMINALS 5**

Z - No Lens

| Clear | White | Amber | Green | Red | Blue | Lens Style                       |
|-------|-------|-------|-------|-----|------|----------------------------------|
| 3     | 8     | D     | J     | P   | V    | Bar                              |
| 4     | 9     | E     | K     | R   | W    | One piece Square                 |
| 5     | A     | F     | L     | S   | Y    | Two piece Square*                |
|       |       |       |       |     |      | (with clear top protective lens) |
| 2     | 7     | C     | H     | N   | U    | Two piece Square*                |
|       |       |       |       |     |      | (with smoke top protective lens) |
| 1     | 6     | B     | G     | M   | T    | Two piece Square*                |
|       |       |       |       |     |      | (with white top protective lens) |

\* All bottom lenses are molded of opaque material. Consult factory for other lens colors. Lens color for LEDs must be clear, white, or match color of LED. Green or blue lenses are not recommended with Neon lamps.

**11 ACTUATOR LOCK FUNCTION AND COLOR 3**

| Lock Color     | Up | Down | Up & Down |
|----------------|----|------|-----------|
| Match Actuator | A  | H    | R         |
| Black          | B  | J    | S         |
| White          | C  | K    | T         |
| Red            | D  | L    | V         |
| Gray           | E  | M    | W         |
| Safety Orange  | F  | N    | Y         |

**12 ACTUATOR LENS OR BODY LEGEND 2**

00 - No Legend

| 21   | 22   | 23   | 24   |
|------|------|------|------|
| OFF  | ON   | O    | I    |
| 25 O | 26 O | 27 O | 28 I |
| F    | N    |      |      |



For additional legend options & codes, visit us at [www.carlingtech.com](http://www.carlingtech.com).

**13 LEGEND ORIENTATION 3**

0 No legend (used with codes 11-18 in selection 12)

| 1             | 2             | 3             | 4             |
|---------------|---------------|---------------|---------------|
| Orientation 1 | Orientation 2 | Orientation 3 | Orientation 4 |

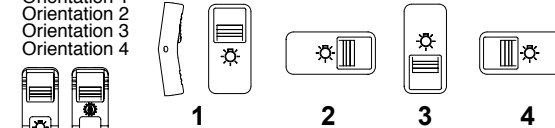

|          |           |          |               |                |        |        |           |            |         |                   |           |                       |                           |   |    |
|----------|-----------|----------|---------------|----------------|--------|--------|-----------|------------|---------|-------------------|-----------|-----------------------|---------------------------|---|----|
| V        | 1         | D        | B             | B              | C      | O      | B         | -          | FA      | P                 | C         | AB                    | -                         | 1 | 00 |
| 1 Series | 2 Circuit | 3 Rating | 4 Termination | 5 Illumination | 6 Lamp | 7 Lamp | 8 Bracket | 9 Actuator | 10 Lens | 11 Actuator Color | 12 Legend | 13 Legend Orientation | 14 Actuator, Lens Legends |   |    |

**1 SERIES**  
V

**2 CIRCUIT**  
Terminal Connections as viewed ( ) - momentary from bottom of switch: SP - single pole - uses terminals 1, 2 & 3. DP - double pole uses terminals 1, 2, 3, 4, 5 & 6. **8 terminal 10 terminal** Terminals 7, 8, 9 & 10 for lamp circuit only.

8 - -7    8 - -7  
1 - -4    1 - -4  
2 - -5    2 - -5  
3 - -6    3 - -6  
10 - -9

|                  |              |                     |              |
|------------------|--------------|---------------------|--------------|
| <b>Position:</b> | <b>1</b>     | <b>2</b>            | <b>3</b>     |
| SP DP:           | 2 & 3, 5 & 6 | Connected Terminals | 1 & 2, 4 & 5 |
| 1 A              | ON           | NONE                | OFF          |
| 2 B              | (ON)         | NONE                | OFF          |
| 3 C              | ON           | NONE                | (OFF)        |
| 4 D              | ON           | NONE                | ON           |
| 5 F              | ON           | NONE                | (ON)         |
| 6 J              | ON           | OFF                 | ON           |
| 7 K              | ON           | OFF                 | (ON)         |
| 8 L              | (ON)         | OFF                 | (ON)         |

**SPECIAL CIRCUITS**

|    |                |              |       |
|----|----------------|--------------|-------|
| H* | 2 & 3          | 2 & 3, 5 & 4 | 5 & 4 |
| G* | 2 & 3, 5 & 6   | 2 & 3        | OFF   |
| M* | (2 & 3, 5 & 6) | 2 & 3        | OFF   |
| R* | (2 & 3, 5 & 6) | 2 & 3        | 2 & 1 |
| E* | 5 & 6          | 5 & 3        | 5 & 1 |
| S* | 2 & 3, 5 & 6   | 2 & 3        | 1 & 2 |

\*Jumper between terminals 2 & 5 for circuits H, G, M, R & S are specified in selection 4. External jumper between terminals 2 & 4 for circuit E are provided by customer. Circuit E may be used for SP OFF-ON-ON circuit.

**3 RATING 3**

|   |  |
|---|--|
| B | .4VA @ 28VDC Resistive                       |
| C | 15A 24V                                      |
| D | 20A 18V                                      |
| E | 20A 12V                                      |
| F | 20A 14V, 10A 14VT (circuit 1, 4, A & D only) |
| F | 10A 14V, 6A 14VT (circuit G only)            |

**4 TERMINATION / BASE STYLE**

| 8 term | 10 Term | Termination                 | Jumper      |
|--------|---------|-----------------------------|-------------|
| 1      | 2       | .250 TAB (QC) no barriers   | No          |
| A      | B       | .250 TAB (QC) with barriers | No          |
| J      | K       | .250 TAB (QC) no barriers   | Yes T2 to 5 |
| 3      | 4       | Solder Lug no barriers      | No          |
| C      | D       | Solder Lug                  | No          |
| 5      | 6       | Wire Leads no barriers      | No          |
| E      | F       | Wire Leads                  | No          |

Note: Codes J & K for circuits H, G & M.

**5 ILLUMINATION**  
Lamp #1: above terminals 1 & 4 end of switch.; Lamp #2 above terminals 3 & 6 end of switch. Positive (+) and negative (-) symbols apply to LED lamps only

| S                                | Lamps | Illumination Type | Lamp wired to Terminals |
|----------------------------------|-------|-------------------|-------------------------|
| S                                | NONE  | -                 | -                       |
| A                                | 1     | INDEPENDENT       | 8 (+) 7 (-)             |
| B                                | 1     | DOWN              | 3 (+) 7 (-)             |
| C                                | 2     | UP                | 3 (+) 7 (-)             |
| D                                | 1     | DOWN              | 3 (+) 7 (-)             |
| E                                | 2     | DOWN              | 1 (+) 7 (-)             |
| F                                | 1     | UP                | 1 (+) 7 (-)             |
| F                                | 2     | UP                | 3 (+) 7 (-)             |
| G                                | 1     | INDEPENDENT       | 8 (+) 7 (-)             |
| G                                | 2     | UP                | 3 (+) 6 (-)             |
| H                                | 1     | INDEPENDENT       | 8 (+) 7 (-)             |
| H                                | 2     | UP                | 3 (+) 7 (-)             |
| <b>SINGLE POLE SWITCHES ONLY</b> |       |                   |                         |
| J                                | 1     | DOWN              | 3 (+) 8 (-)             |
| K                                | 2     | INDEPENDENT       | 6 (+) 7 (-)             |
| K                                | 1     | INDEPENDENT       | 8 (+) 7 (-)             |
| K                                | 2     | INDEPENDENT       | 6 (+) 7 (-)             |
| <b>DOUBLE POLE SWITCHES ONLY</b> |       |                   |                         |
| L                                | 1     | DOWN              | 3 (+) 6 (-)             |
| M                                | 1     | UP                | 3 (+) 6 (-)             |
| N                                | 1     | DOWN              | 3 (+) 6 (-)             |
| N                                | 2     | DOWN              | 1 (+) 4 (-)             |
| P                                | 1     | UP                | 1 (+) 4 (-)             |
| P                                | 2     | UP                | 3 (+) 6 (-)             |
| U                                | 1     | INDEPENDENT       | 8 (+) 7 (-)             |
| U                                | 2     | INDEPENDENT       | 10 (+) 9 (-)            |

**6 & 7 LAMP**

|                   |          |          |                         |                       |                       |
|-------------------|----------|----------|-------------------------|-----------------------|-----------------------|
| No lamp           | 0        | 2 250VAC | 6 12V superbright Green | 7 18V superbright Red | 8 24V superbright Red |
| Neon              | 1 125VAC | 5 6V     |                         |                       |                       |
| Incandescent LED* | 4 3V     |          |                         |                       |                       |
| 2VDC              | Red A    | Amber L  | F                       |                       |                       |
| 6VDC              | B        | M        | G                       | R                     |                       |
| 12VDC             | C        | N        | H                       | S                     |                       |
| 24VDC             | D        | P        | J                       | T                     | V                     |

\* Consult factory for "daylight bright" LED options. Typical current draw for LED is 20ma.

**8 BRACKET COLOR & PANEL SEAL**

|       |             |            |            |
|-------|-------------|------------|------------|
| Color | No Gasket B | 1 Gasket C | 2 Gasket D |
| Black | B           | C          | D          |
| Gray  | G           | H          | J          |
| White | W           | Y          | Z          |

**9 ACTUATOR STYLE**

|    |                                    |
|----|------------------------------------|
| 0  | No Actuator - Furnished separately |
| FA | Contura XIV                        |
| FB | Contura XIV - Laser Etched         |



**10 LENS COLOR / STYLE**

|                 |             |       |       |     |      |
|-----------------|-------------|-------|-------|-----|------|
| 0 - No Actuator | Z - No Lens |       |       |     |      |
| Clear           | White       | Amber | Green | Red | Blue |
| 1 6 B           | G           | M     | T     |     |      |
| 2 7 C           | H           | N     | U     |     |      |
| 3 8 D           | J           | P     | V     |     |      |
| 4 9 E           | K           | R     | W     |     |      |
| 5 A F           | L           | S     | Y     |     |      |
| 5 A             | N/A         | N/A   | N/A   | N/A |      |

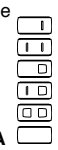
Legend:  PAD Printed, Laser-Etched

Lens color for LEDs must be clear, white, or match color of LED. Green or blue lenses are not recommended with Neon lamps.

**11 ACTUATOR COLOR 1**

|   |                   |
|---|-------------------|
| O | N/A - No Actuator |
| C | Black             |
| S | Red               |
| Y | White             |

**12 ACTUATOR LENS or BODY LEGEND 2**

|        |                                       |        |        |
|--------|---------------------------------------|--------|--------|
| 00     | No Legend this location / No actuator |        |        |
| 11 ON  | 12 OFF                                | 13 I   | 14 O   |
| OFF    | ON                                    | O      | I      |
| 15 O O | 16 O O                                | 17 O I | 18 I O |
| F N    | N F                                   |        |        |
| F      | F                                     |        |        |



**13 LEGEND ORIENTATION**

|   |               |
|---|---------------|
| 0 | No legend     |
| 1 | Orientation 1 |
| 2 | Orientation 2 |
| 3 | Orientation 3 |
| 4 | Orientation 4 |

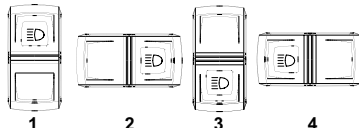

**14 ACTUATOR / LENS LEGEND**

00 No legend this location / no actuator (used with codes 11-18 in selection 12) Selection 14 required when switch requires two legends. If the two legends consist of one lens and one body legend, lens legend must be specified in selection 12; body legend specified in selection 14.

For legend options & codes, visit us at [www.carlingtech.com](http://www.carlingtech.com).

**Notes:**  
Consult factory to verify horsepower rating for your particular circuit choice.

- 1 Custom colors are available. Consult factory.
- 2 White imprinting is standard on black actuators; Black imprinting is standard on white, red and gray actuators.
- 3 Additional ratings available. See V-Series Switch Accessories page.

**V 1 D A B W 0 B - FC Z B 00 - 0**

1 Series    2 Circuit    3 Rating    4 Termination Illumination    5 Lock    6 Lamp    7 Bracket    8 Actuator    9 Lens    10 Actuator Color    11 Legend    12 Legend Orientation

**1 SERIES**  
V

**2 CIRCUIT**

Terminal Connections as viewed ( ) - momentary from bottom of switch: SP - single pole - uses terminals 1, 2 & 3. **8 terminal 10 terminal** DP - double pole uses terminals 1, 2, 3, 4, 5 & 6. 8 - -7    8 - -7    Terminals 7, 8, 9 & 10 for lamp circuit only.  
1 - -4    1 - -4  
2 - -5    2 - -5  
3 - -6    3 - -6  
10 - -9

**Position:**

| SP DP | 1    | 2    | 3    |
|-------|------|------|------|
| 1 A   | ON   | NONE | OFF  |
| - B   | (ON) | NONE | OFF  |
| 4 D   | ON   | NONE | ON   |
| 6 J   | ON   | OFF  | ON   |
| 7 K   | ON   | OFF  | (ON) |
| 8 L   | (ON) | OFF  | (ON) |
| 9 N   | OFF  | NONE | ON   |

**SPECIAL CIRCUITS**

|    | 1              | 2            | 3     |
|----|----------------|--------------|-------|
| H* | 2 & 3          | 2 & 3, 5 & 4 | 5 & 4 |
| G* | 2 & 3, 5 & 6   | 2 & 3        | OFF   |
| M* | (2 & 3, 5 & 6) | 2 & 3        | OFF   |
| R* | (2 & 3, 5 & 6) | 2 & 3        | 2 & 1 |
| E* | 5 & 6          | 5 & 3        | 5 & 1 |
| S* | 2 & 3, 5 & 6   | 2 & 3        | 1 & 2 |

\*Jumper between terminals 2 & 5 for circuits H,G,M,R & S are specified in selection 4. External jumper between terminals 2 & 4 for circuit E are provided by customer. Circuit E may be used for SP OFF-ON-ON circuit.

**3 RATING<sup>3</sup>**

|   |  |
|---|--|
| 1 | .4VA @ 28VDC Resistive                       |
| B | 15A 24V                                      |
| C | 20A 18V                                      |
| D | 20A 12V                                      |
| E | 20A 14V, 10A 14VT (circuit 1, 4, A & D only) |
| F | 10A 14V, 6A 14VT (circuit G only)            |

**4 TERMINATION / BASE STYLE**

| 8 term | 10 Term | Termination                 | Jumper      |
|--------|---------|-----------------------------|-------------|
| 1      | 2       | .250 TAB (QC) no barriers   | No          |
| A      | B       | .250 TAB (QC) with barriers | No          |
| J      | K       | .250 TAB (QC) no barriers   | Yes T2 to 5 |

Note: Codes J & K for circuits H, G & M.

**5 ILLUMINATION**

Lamp #1: above terminals 1 & 4 end of switch.; Lamp #2 above terminals 3 & 6 end of switch. Positive (+) and negative (-) symbols apply to LED lamps only

| S    | Lamps | Illumination Type | Lamp wired to Terminals |
|------|-------|-------------------|-------------------------|
| NONE | -     | -                 | -                       |
| C    | 2     | UP                | 3 (+) 7 (-)             |
| H    | 2     | INDEPENDENT       | 8 (+) 7 (-)             |

**DOUBLE POLE SWITCHES ONLY**

|   |   |    |             |
|---|---|----|-------------|
| M | 1 | UP | 3 (+) 6 (-) |
|---|---|----|-------------|

**6 LOCK OPTION**

|   |                  |
|---|------------------|
| W | Low Profile Lock |
|---|------------------|

Notes:

Consult factory to verify horsepower rating for your particular circuit choice.

1 Custom colors are available. Consult factory.

2 White imprinting is standard on black actuators; Black imprinting is standard on white, red and gray actuators.

3 Additional ratings available. See V-Series Switch Accessories page.

**7 LAMP**

|              |   |          |          |                   |                   |                   |
|--------------|---|----------|----------|-------------------|-------------------|-------------------|
| No lamp      | 0 | 1 125VAC | 2 250VAC | 6 12V superbright | 7 18V superbright | 8 24V superbright |
| Neon         | 1 | 4 3V     | 5 6V     | Green             | Red               |                   |
| Incandescent | 4 |          |          |                   |                   |                   |
| LED*         |   | Red      | Amber    | Green             | Red               |                   |
| 2VDC         | A | L        | F        | R                 |                   |                   |
| 6VDC         | B | M        | G        | S                 |                   |                   |
| 12VDC        | C | N        | H        | T                 |                   |                   |
| 24VDC        | D | P        | J        | V                 |                   |                   |

\* Consult factory for "daylight bright" LED options. Typical current draw for LED is 20ma.

**8 BRACKET COLOR & PANEL SEAL**

| Color | No Gasket | 1 Gasket | 2 Gasket |
|-------|-----------|----------|----------|
| Black | B         | C        | D        |
| Gray  | G         | H        | J        |
| White | W         | Y        | Z        |

**9 ACTUATOR COLOR / STYLE**

|    |                         |
|----|-------------------------|
| FC | Black - Standard Rocker |
| FD | Black - Laser Etched    |
| FS | Red - Standard Rocker   |
| FT | Red - Laser Etched      |



**10 LENS COLOR / STYLE**

| Z - No Lens | Clear | White | Amber | Green | Red | Blue         |
|-------------|-------|-------|-------|-------|-----|--------------|
| 1           | 6     | B     | G     | M     | T   |              |
| 3           | 8     | D     | J     | P     | V   | PAD Printed  |
| 5           | A     | N/A   | N/A   | N/A   | N/A | Laser-Etched |

Lens color for LEDs must be clear, white, or match color of LED. Green or blue lenses are not recommended with Neon lamps.

**11 ACTUATOR LOCK COLOR / FUNCTION<sup>1</sup>**

| Lock Color     | UP | DOWN | UP & DOWN | CENTER |
|----------------|----|------|-----------|--------|
| Match Actuator | A  | H    | R         | 1      |
| Black          | B  | J    | S         | 2      |
| White          | C  | K    | T         | 3      |
| Red            | D  | L    | V         | 4      |
| Orange         | E  | M    | W         | 5      |
| Gray           | F  | G    | N         | 6      |

**12 ACTUATOR LENS or BODY LEGEND<sup>2</sup>**

|                |     |      |      |      |
|----------------|-----|------|------|------|
| 00 - No Legend | 21  | 22   | 23   | 24   |
|                | OFF | ON   | O    | I    |
| 25             | O   | 26 O | 27 O | 28 I |
|                | F   | N    |      |      |

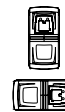

**13 LEGEND ORIENTATION**

|   |               |
|---|---------------|
| 0 | No legend     |
| 1 | Orientation 1 |
| 2 | Orientation 2 |
| 3 | Orientation 3 |
| 4 | Orientation 4 |

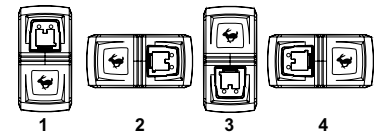

**Dimensional Specifications: in. [mm]**

**CONTURA II**

SHOWN WITH SQUARE LENS

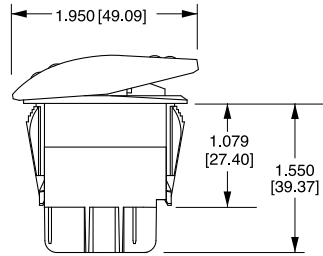
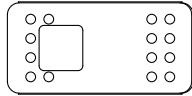

**8 TERMINAL BASE W/BARRIERS**

**CONTURA III**

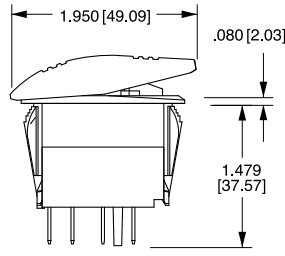
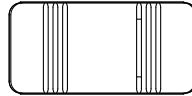

**8 TERMINAL BASE W/O BARRIERS**

**CONTURA IV**

SHOWN WITH BAR LENS

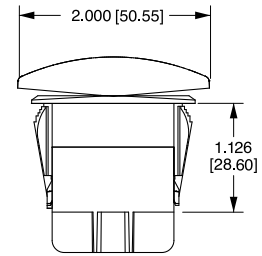
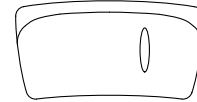

**10 TERMINAL BASE W/BARRIERS**

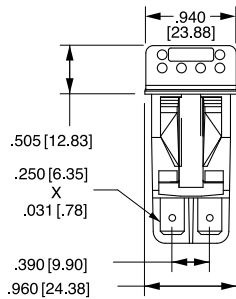

**8 TERMINAL BASE W/BARRIERS**

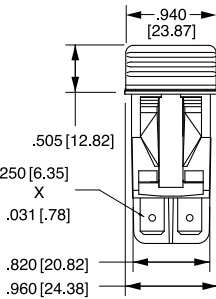

**10 TERMINAL BASE W/BARRIERS**

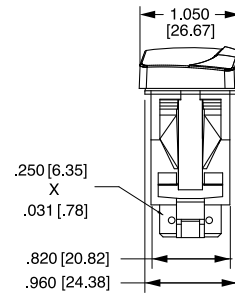

**10 TERMINAL BASE W/O BARRIERS**

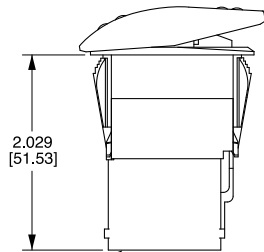

**SWITCH SHOWN WITH VCH CONNECTOR 8 TERMINAL**

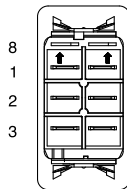

**BOTTOM VIEW TERMINAL ARRANGEMENT 8 TERMINAL BASE**

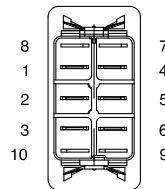

**BOTTOM VIEW TERMINAL ARRANGEMENT 10 TERMINAL BASE**

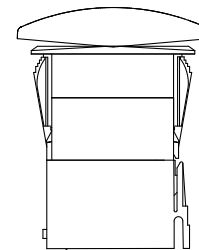

**SWITCH SHOWN WITH VC1 CONNECTOR 10 TERMINAL**



**Dimensional Specifications: in. [mm]**

**CONTURA V**

SHOWN WITH  
BAR LENS

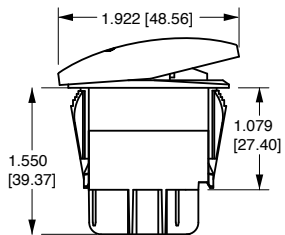
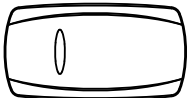

**8 TERMINAL BASE  
W/BARRIERS**

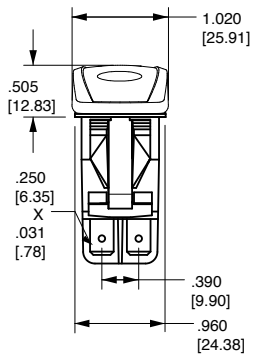

**8 TERMINAL BASE  
W/BARRIERS**

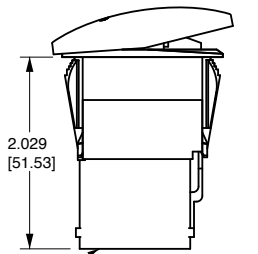

SWITCH SHOWN WITH  
VCH CONNECTOR 8  
TERMINAL

**CONTURA V**

SHOWN WITH  
LOW PROFILE LOCK

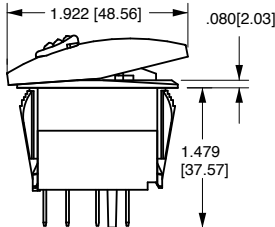
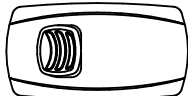

**8 TERMINAL BASE  
W/O BARRIERS**

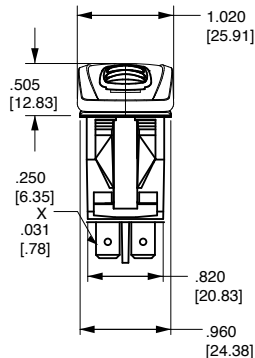

**8 TERMINAL BASE  
W/O BARRIERS**

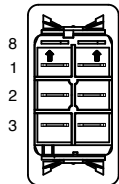

**BOTTOM VIEW  
TERMINAL  
ARRANGEMENT  
8 TERMINAL BASE**

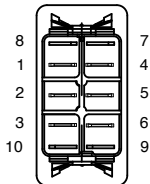

**BOTTOM VIEW  
TERMINAL  
ARRANGEMENT  
10 TERMINAL BASE**

**CONTURA VI**

SHOWN WITH OVAL  
LENS

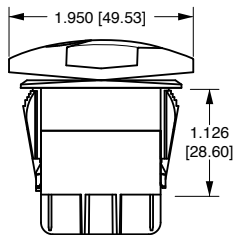

**10 TERMINAL BASE  
W/BARRIER AND  
LAMP TERMINAL**

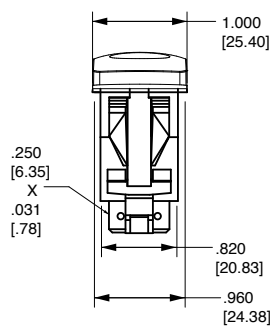

**10 TERMINAL BASE  
W/O BARRIERS**

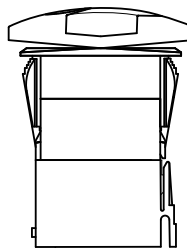

SWITCH SHOWN WITH  
VC1 CONNECTOR 10  
TERMINAL

**CONTURA VII**

SHOWN WITH LARGE LENS  
AND BAR LENS

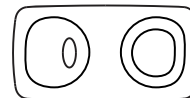

**10 TERMINAL BASE  
W/O BARRIERS**

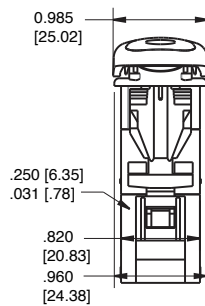

**10 TERMINAL BASE  
W/O BARRIERS**



SWITCH SHOWN  
WITH VC1  
CONNECTOR 10  
TERMINAL

**Dimensional Specifications: in. [mm]**

**CONTURA X**  
SHOWN WITH RAISED BRACKET

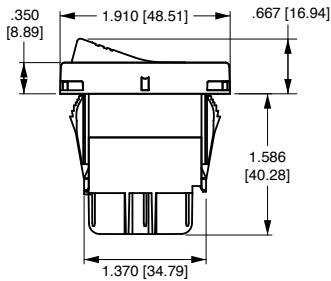
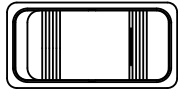

**8 TERMINAL BASE W/BARRIERS**

**CONTURA XI**  
SHOWN WITH RAISED BRACKET AND TWO SQUARE LENSES

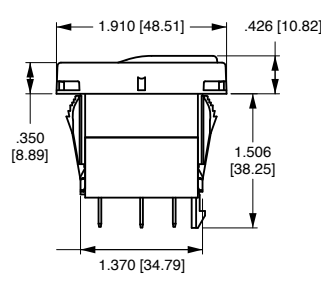
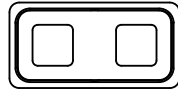

**10 TERMINAL BASE W/O BARRIERS**

**CONTURA XII**  
SHOWN WITH PADDLE ACTUATOR

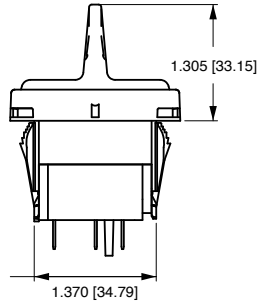
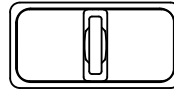

**8 TERMINAL BASE W/O BARRIERS**

**CONTURA XIV**  
SHOWN WITH LARGE LENS

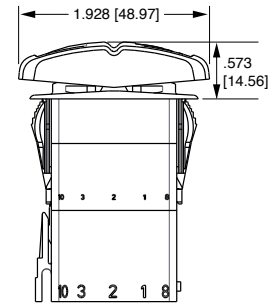
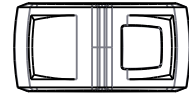

**10 TERMINAL BASE W/O BARRIERS**

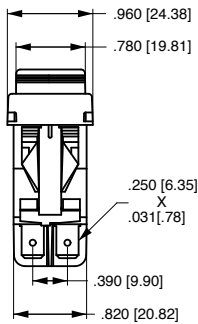

**8 TERMINAL BASE W/BARRIERS**

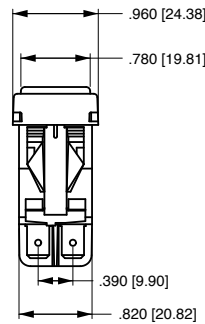

**10 TERMINAL BASE W/BARRIERS**

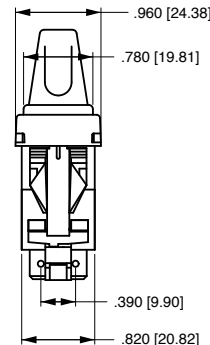

**10 TERMINAL BASE W/O BARRIERS**

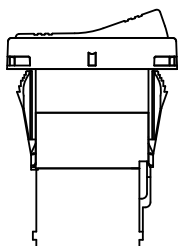
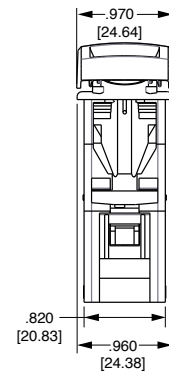

**SWITCH SHOWN WITH VCH CONNECTOR 8 TERMINAL**

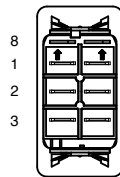

**BOTTOM VIEW TERMINAL ARRANGEMENT 8 TERMINAL BASE**

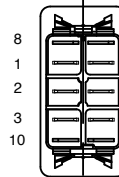

**BOTTOM VIEW TERMINAL ARRANGEMENT 10 TERMINAL BASE**

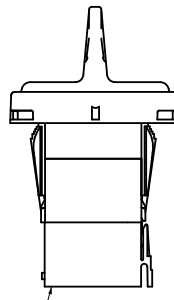

**SWITCHES SHOWN WITH VC1 CONNECTOR 10 TERMINAL**

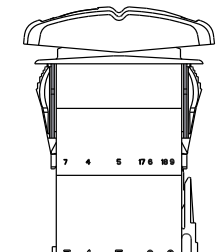

**Circuit Diagrams:**

| CIRCUIT CODE | CIRCUIT DIAGRAM |
|--------------|-----------------|
| 1            |                 |
| 2            |                 |
| 3            |                 |
| 4            |                 |
| 5            |                 |
| 6            |                 |
| 7            |                 |
| 8            |                 |

| CIRCUIT CODE | CIRCUIT DIAGRAM |
|--------------|-----------------|
| A            |                 |
| B            |                 |
| C            |                 |
| D            |                 |
| E            |                 |
| F            |                 |
| G            |                 |
| H            |                 |

| CIRCUIT CODE | CIRCUIT DIAGRAM |
|--------------|-----------------|
| J            |                 |
| K            |                 |
| L            |                 |
| M            |                 |
| R            |                 |
| S            |                 |

| SYMBOL LEGEND |   |
|---------------|---|
| SYM.          | DEFINITION                                      |
|               | DESIGNATES TERMINALS AND CONTACTS               |
|               | DESIGNATES MAINTAINED CIRCUITS                  |
|               | DESIGNATES OTHER POSITION                       |
|               | DESIGNATES MOMENTARY CIRCUITS                   |
|               | DESIGNATES TWO POSITION CONNECTION              |
|               | DESIGNATES EXTERNAL JUMPER PROVIDED BY CUSTOMER |

### Lamp Circuit Diagrams:

| LAMP CIRCUIT CODE | CIRCUIT DIAGRAM | LAMP CIRCUIT CODE | CIRCUIT DIAGRAM | LAMP CIRCUIT CODE | CIRCUIT DIAGRAM | LAMP CIRCUIT CODE | CIRCUIT DIAGRAM |
|-------------------|-----------------|-------------------|-----------------|-------------------|-----------------|-------------------|-----------------|
| A / 1             |                 | F / 6             |                 | L / 9             |                 | SPECIAL #1        |                 |
| B / 2             |                 | G / 7             |                 | M / R             |                 | SPECIAL #3        |                 |
| C / 3             |                 | H / Z             |                 | N / T             |                 | SPECIAL #4        |                 |
| D / 4             |                 | J / 8             |                 | P / V             |                 |                   |                 |
| E / 5             |                 | K / W             |                 | U / Y             |                 |                   |                 |

### J-Series Hazard Warning Circuit Diagrams:

| CIRCUIT CODE | CIRCUIT DIAGRAM | CIRCUIT CODE | CIRCUIT DIAGRAM |
|--------------|-----------------|--------------|-----------------|
| J1           |                 | J5           |                 |
| J2           |                 | JA           |                 |
| J3           |                 | JJ           |                 |
| J4           |                 | JK           |                 |

NOTE:  
J circuits are available for all non-locking V-Series styles.  
Consult factory for partnumber details.

| SYMBOL LEGEND |                                   |
|---------------|-----------------------------------|
| SYM.          | DEFINITION                        |
| ○             | DESIGNATES TERMINALS AND CONTACTS |
| ○             | DESIGNATES LAMP LOCATION          |

**Reduce inventory levels and cost by stocking actuators and base switches separately.**

**Contura II, III, IV, V, VI, VII, X, XI, XII, XIV Base switches separately:** specify **V** with code selections 2-8 in the ordering schemes.

**Contura II, III, IV, V Actuator only: VV** with code **A** or **C** for selection 9, & with selections 10-14 in the ordering schemes.

**Contura VI Actuator with lenses and inserts only: VV** with code selections 9-16

**Contura II, III, IV, V, VII Actuator only: VV** with code **A, C, E, G, P** or **Z** for selection 9 & with selections 10-14 in the ordering schemes.

**Contura X, XI, XII, XIV actuators with lenses separately: VV** with code selections 9-14 in the ordering schemes.

**Panel Seal: VPS**

**Contura X & XI actuators without lenses separately:**

**VVR 6 1 00 1**

1 Actuator Separately 2 Actuator Style/Color 3 Lens Opening 4 Actuator Legend 5 Legend Orientation

**1 CONTURA X & XI ACTUATOR SEPARATELY**  
VVR

**2 ACTUATOR STYLE & COLOR**

|            |       |      |       |     |
|------------|-------|------|-------|-----|
|            | Black | Gray | White | Red |
| Contura X  | 1     | 2    | 3     | 4   |
| Contura XI | 6     | 7    | 8     | 9   |

**3 LENS OPENING FOR 1**

1 One bar lens 5 square lens on top/  
2 One bar lenses bar lens on bottom  
3 One square lens (Contura X only)  
4 two square lens

**4 ACTUATOR LENS OR BODY LEGEND**

00 - No Legend this location

|        |        |        |        |
|--------|--------|--------|--------|
| 11 ON  | 12 OFF | 13 I   | 14 O   |
| OFF    | ON     | O      | I      |
| 15 O O | 16 O O | 17 O I | 18 I O |
| F N    | N F    |        |        |
| F F    | F F    |        |        |

For additional legend options & codes, visit us at [www.carlingtech.com](http://www.carlingtech.com).

**5 LEGEND ORIENTATION 1**

0 No legend 1 Orientation 1 2 Orientation 2 3 Orientation 3 4 Orientation 4

**Contura XII actuators without lenses separately:**

**VVP J 1 Z 21 1 00**

1 Actuator 2 Style & Color 3 Lens Opening 4 Lens Opening 5 Legend 6 Legend Orientation 7 Legend Orientation

**1 CONTURA XII ACTUATOR SEPARATELY**  
VVP

**2 ACTUATOR STYLE & COLOR**

J Black K Gray N White M Red

**3,4 LENS OPENING FOR**

Z No lens 1 Bar lens 2 Square lens

**5, 7 LENS OR BODY LEGEND 2**

|                |        |        |      |      |
|----------------|--------|--------|------|------|
| 00 - No Legend | 21 OFF | 22 ON  | 23 O | 24 I |
|                | 25 O F | 26 O N | 27 O | 28 I |

For additional legend options & codes, visit us at [www.carlingtech.com](http://www.carlingtech.com).

**6 LEGEND ORIENTATION 3**

0 No legend 1 Orientation 1 2 Orientation 2

**Contura X, XI & XII actuator lens assembly separately:**

**VVL 2 1 00 0**

1 Lens Separately 2 Lens Style 3 Lens Color 4 Legend 5 Legend Orientation

**1 CONTURA X, XI & XII LENS SEPARATELY**  
VVL

**2 LENS STYLE 3**

1 Bar lens 2 One Piece Square lens 3 Bottom of Two-Piece Square lens 5

**3 TRANSLUCENT LENS COLOR**

1 Clear 2 White 3 Amber 4 Green 4 5 Red 6 Blue 4

**4 LENS OR BODY LEGEND 2**

|                |        |        |      |      |
|----------------|--------|--------|------|------|
| 00 - No Legend | 21 OFF | 22 ON  | 23 O | 24 I |
|                | 25 O F | 26 O N | 27 O | 28 I |

For additional legend options & codes, visit us at [www.carlingtech.com](http://www.carlingtech.com).

**5 LEGEND ORIENTATION 3**

0 No legend 1 Orientation 1 2 Orientation 2 3 Orientation 3 4 Orientation 4

**Contura X, XI & XII top piece of 2-piece lens separately:**

**VVT 1**

1 Lens Separately 2 Color

**1 TOP OF LENS SEPARATELY**  
VVT

**2 COLOR**  
1 Clear 2 Smoke 3 White

**Contura X, XI & XII actuator lens assembly:**



**Notes:**

- If actuator lens opening for 2 bar or 2 square lenses, legend orientation 0,1, or 2 must be chosen.
- Center of actuator marking not available for Contura XII.
- Legend is not available for bar style lens.
- Not recommended with neon lamps.
- Must also order top piece of 2 piece square lens separately.

## Easily integrate Contura products into your system, with Contura Accessories

### Contura Connectors

| Q.C. SELECTION GUIDE          |             |                  |            |                       |             |       |
|-------------------------------|-------------|------------------|------------|-----------------------|-------------|-------|
| COMPANY SERIES                | PART NO     |                  | WIRE RANGE |                       | ORIENTATION |       |
|                               | PLAIN BRASS | TIN PLATED BRASS | AWG        | MM <sup>2</sup> (REF) |             |       |
| PACKARD 58 SERIES             | 02965580    |                  | 12         | 3.0                   | B           |       |
|                               | 02965471    | 12010601         | (2)16-14   | (2)1.0-2.0            |             |       |
|                               | 02965470    |                  | 16-14      | 1.0-2.0               |             |       |
|                               | 02965469    | 06288318         | 20-18      | .5-.8                 |             |       |
| PACKARD METRI-PACK 630 SERIES |             | 12084590         | 10         | 5.0                   | A           |       |
|                               |             | 12052224         | 12         | 3.0                   |             |       |
|                               |             | 12015870         | 16-14      | 1.0-2.0               |             |       |
|                               |             | 12020035         | (2)22-18   | (2).5-.8              |             |       |
|                               |             | 12015832         | 12015869   | 20-18                 |             | .5-.8 |
|                               |             | 12052222         | 20-22      | .35-.5                |             |       |
| AMP 250 SERIES FASTIN-FASTON  | 60253-1     | 60253-2          | 16-12      | 1.3-3                 | B           |       |
|                               | 42100-1     | 42100-2          | (2) 16     | (2) 1.3               |             |       |
|                               | 60295-1     | 60295-2          | 22-18      | .3-.9                 |             |       |

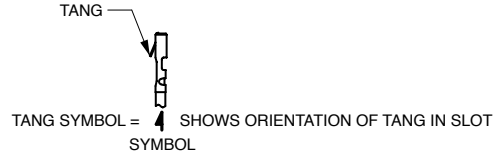

**NOTE:** Consult Delphi Packard and/or Amp on actual part numbers and availability. AMP is a registered trademark of AMP Inc. Harrisburg, PA. Delphi Packard is a registered trademark of Delphi-Packard Electrical Systems Warren, Ohio

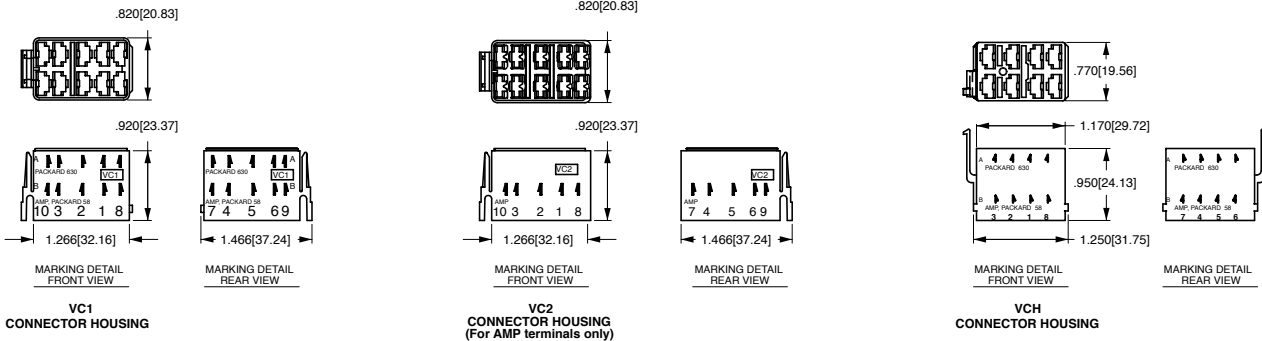

### Contura X Boot (P/N VB1-01)

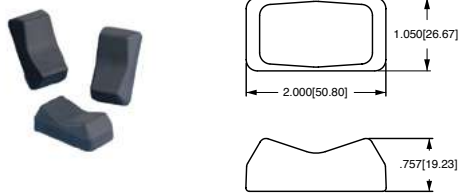

### Additional V-Series Ratings

- 1 .4VA @ 28VDC Resistive
- 4 10A 250VAC 1/2 HP, 15A 125 VAC 1/2 HP, No Agency Listings
- 5<sup>1</sup> 10A 250VAC 1/2 HP, 15A 125 VAC 1/2 HP, UL Recognized, CSA Certified
- B 15A 24V
- C 20A 18V
- D 20A 12V
- E 20A 14V, 10A 14VT (circuits 1, 4, A, & D only)
- F 10A 14V, 6A, 14VT (circuit G only)
- G 20A 6V
- H 20A 3V
- L<sup>2</sup> 15A 125 VAC, 10A 250VAC, 1/2 HP 125-250 VAC; 6A 125 VAC L
- M .4VA/20A 12V (combi-contact)  
(combination gold/silver contacts for borderline dry circuit applications)
- N .4VA/15A 24V (combi-contact)  
(combination gold/silver contacts for borderline dry circuit applications)

### Contura II, III, IV, V, VI & VII Actuator Removal Tool (P/N VRT)

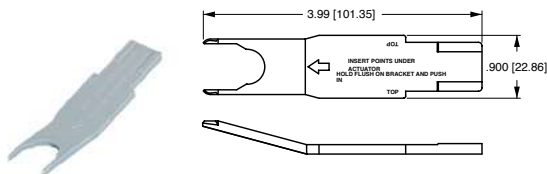

#### NOTES

- Consult factory to determine availability for individual circuits and their HP rating.
1. Not available with Contura 7 or 14 rocker styles.
  2. Rating L available with circuits 1, 4, A & D only.

## Contura Mounting Panels Dimensional Specifications: in. [mm]

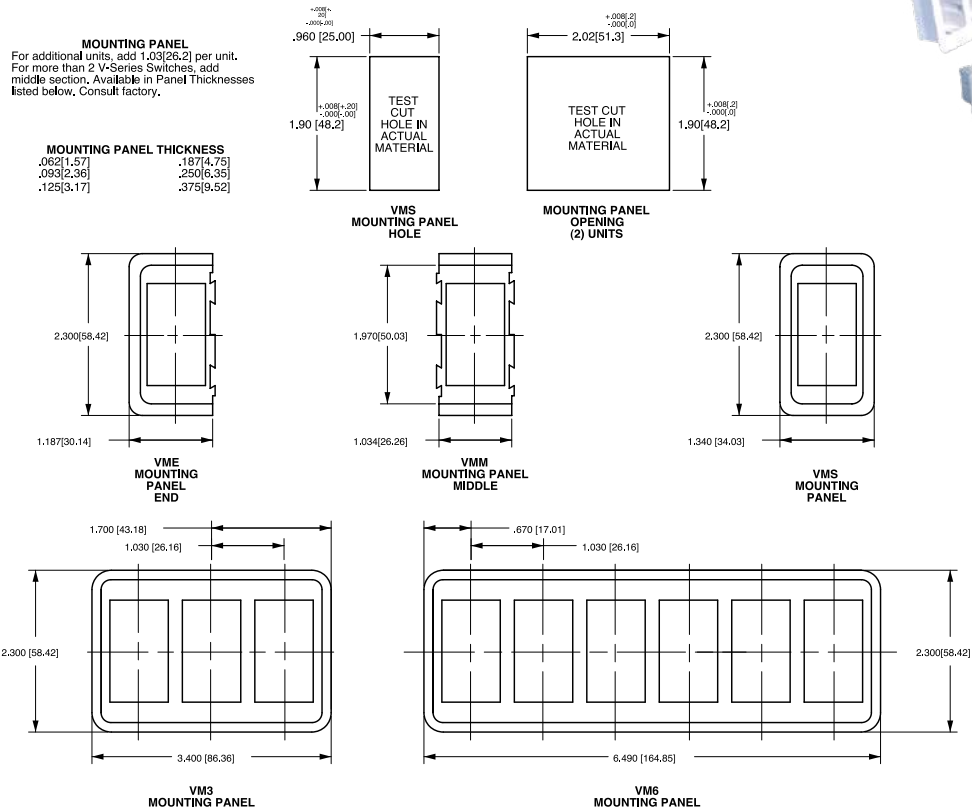

## Contura Hole Plug Dimensional Specifications: in. [mm]

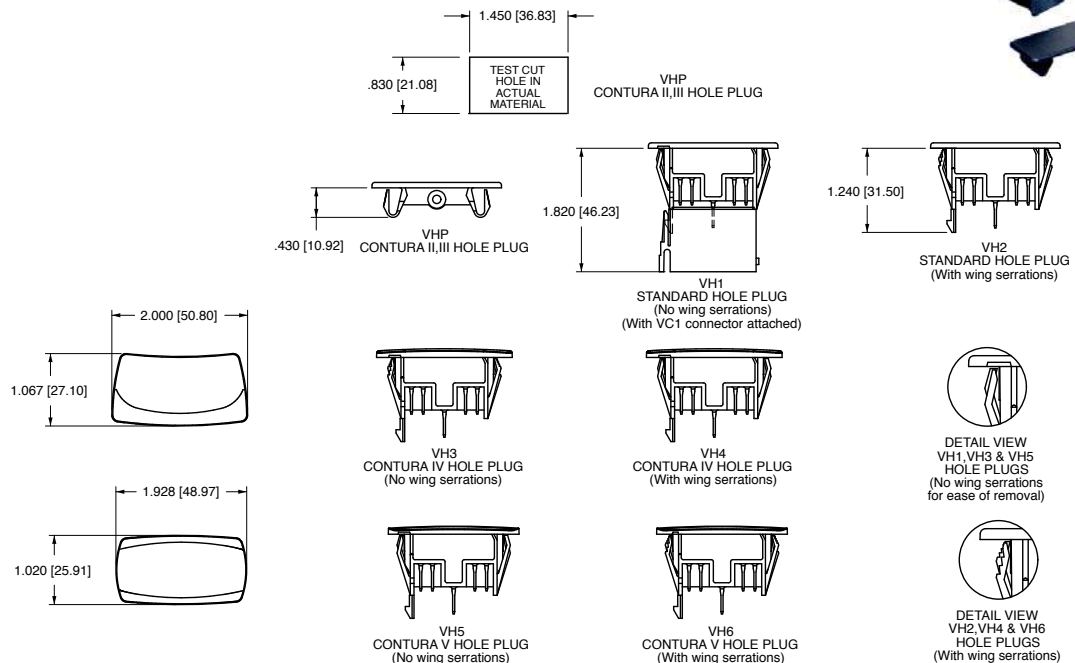





## Authorized Sales Representatives and Distributors

Click on a region of the map below to find your local representatives and distributors or visit [www.carlingtech.com/findarep](http://www.carlingtech.com/findarep).



## About Carling

Founded in 1920, Carling Technologies is a leading manufacturer of electrical and electronic switches and assemblies, circuit breakers, electronic controls, power distribution units, and multiplexed power distribution systems. With four ISO registered manufacturing facilities and technical sales offices worldwide, Carling Technologies Sales, Service and Engineering teams do much more than manufacture electrical components, they engineer powerful solutions! To learn more about Carling please visit [www.carlingtech.com/company-profile](http://www.carlingtech.com/company-profile).

To view all of Carling's environmental, quality, health & safety certifications please visit [www.carlingtech.com/environmental-certifications](http://www.carlingtech.com/environmental-certifications)

## **Worldwide Headquarters**

Carling Technologies, Inc.  
60 Johnson Avenue, Plainville, CT 06062  
**Phone:** 860.793.9281 **Fax:** 860.793.9231  
**Email:** sales@carlingtech.com

**Northern Region Sales Office:** nrsm@carlingtech.com  
**Southeast Region Sales Office:** sersm@carlingtech.com  
**Midwest Region Sales Office:** mrsrm@carlingtech.com  
**West Region Sales Office:** wrsm@carlingtech.com  
**Latin America Sales Office:** larsm@carlingtech.com

## **Asia-Pacific Headquarters**

Carling Technologies, Asia-Pacific Ltd.,  
Suite 1607, 16/F Tower 2, The Gateway,  
Harbour City, 25 Canton Road,  
Tsimshatsui, Kowloon, Hong Kong  
**Phone:** Int + 852-2737-2277 **Fax:** Int + 852-2736-9332  
**Email:** sales@carlingtech.com.hk

**Shenzhen, China:** shenzhen@carlingtech.com  
**Shanghai, China:** shanghai@carlingtech.com  
**Pune, India:** india@carlingtech.com  
**Kaohsiung, Taiwan:** taiwan@carlingtech.com  
**Yokohama, Japan:** japan@carlingtech.com

## **Europe | Middle East | Africa Headquarters**

Carling Technologies LTD  
4 Airport Business Park, Exeter Airport,  
Clyst Honiton, Exeter, Devon, EX5 2UL, UK  
**Phone:** Int + 44 1392.364422 **Fax:** Int + 44 1392.364477  
**Email:** ltd.sales@carlingtech.com

**Germany:** gmbh@carlingtech.com  
**France:** sas@carlingtech.com



**Carling Technologies®**

Innovative Designs. Powerful Solutions.