

Pilot's Guide

Engine Data Management

EDM-930

Primary

TSO

Copyright © 2010 J.P. Instruments, Inc.
All Rights Reserved

J.P. INSTRUMENTS INC.

Information: P. O. Box 7033
Huntington Beach, CA 92646

Factory: 3185-B Airway Ave.
Costa Mesa, CA 92626

(714) 557-3805 Fax (714) 557-9840

www.jp instruments.com

Printed in the United States of America

Rev K 02-16

Table of Contents

Section 1 - Getting Started	1
Display View Angle	2
List of abbreviations and acronyms	3
Fuel Flow Computer Basics	4
Control Button Basics	4
Display Screen Basics	5
Remote Auxiliary Display Basics	5
RPM and MAP Display Basics	5
Linear Bar Graph Display Basics	6
Scanner® Display Basics	7
LeanFind Basics	7
Section 2 - Interpreting Data	8
Operation for each Phase of Flight	8
Typical Normal Measurements	10
Section 3 - Displays and Controls	14
Control Buttons	14
RPM and MAP Displays	17
Scanner Displays	17
Remote Auxiliary Display	20
Hobbs Display	20
Dimming the Display	20
Section 4 - Operating Modes	21
Automatic Mode	21
Manual Mode	22
Section 5 - Lean Find	24
Lean Find Procedure—General Explanation	29
Expanded Leaning Procedures	33
Section 6 - Fuel Flow Operation	34
Fuel Management	34
Start Up Fuel	35
Resetting ‘USD’	39
Trip Mode (Accumulate Trip Totalizer)	39
Scanner Fuel Flow Display Select	40
Section 7 - Alarms	41
Non-primary Alarm Priority	41
Section 8 - Memory and Data Download	42
Downloading Data from the EDM	43
Transferring data from the USB Flash Drive to a PC	43

Section 9 - First Time Setup and Customization	44
Pilot Programming Mode	46
Adjusting the HP Constant for Rich of Peak Operation	52
Adjusting the MAP	52
Adjusting the HP Value	53
Fuel Flow K factor	54
Programming Trip Mode	56
Setting the GPS Com Format	57
Section 10 - Custom Key Card	57
Section 11 - Setting Fuel Calibration Points	58
Getting Started... using the EDM as a meter.	59
After you have collected your data	60
Troubleshooting the EDM	62
Troubleshooting the EDM	62
Diagnostic Testing on Startup and During Flight	63
Diagnostic Messages	64
Section 12 - Appendices	66
TSO-only differences from Primary Instruments	66
Shock Cooling	67
Rear Apron Connector Locations	68
Connector pin assignments	68
Connector pin assignments	69
Navigation Data Formats	70
Navigation Data Ports for GPS Comm	71
Interface connections to selected GPS models	71

EDM Config Editor

<u>1. Overview</u>	73
<u>2. DISCLAIMER</u>	73
<u>3. Starting EDM930/960 Configuration Editor</u>	74
<u>4. Changing Gauge Layout</u>	75
<u>5. Removing Fuel Level Gauges from display</u>	76
<u>6. Replacing Gauges</u>	78
<u>7. Changing Gauge Markings</u>	79
<u>8. Gauge Details Screen</u>	80
<u>9. Gauge Range and Alarm Limits</u>	81
<u>10. Color Bands</u>	82
<u>11. Options</u>	82
<u>12. Modifying Aircraft Information</u>	83
<u>13. Changing Tail Number</u>	83
<u>14. Change Number of Engine Cylinders</u>	84
<u>15. Changing fuel units</u>	85
<u>16. Changing Main Tank Size</u>	85
<u>17. Changing Channels Monitored</u>	86
<u>18. Changing Alarm Values</u>	87
<u>19. EDM Alarms Screen</u>	87
<u>20. Restoring EDM to a Previous Configuration</u>	88
<u>21. Restoring EDM to Factory Configuration</u>	89

Section 13 - Technical Support	90
Index	91
<u>QUICK REFERENCE</u>	95

EDM-930 SYSTEM DISPLAYS

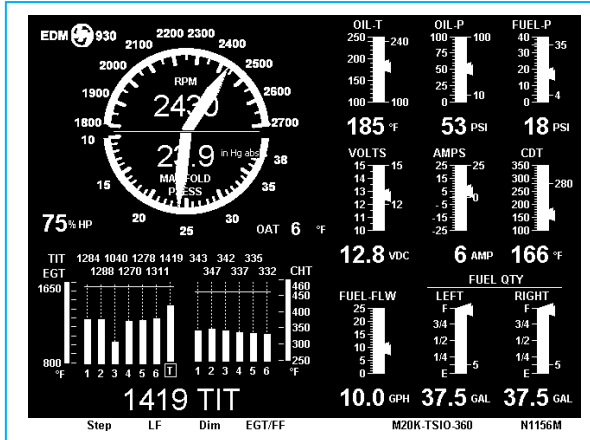

EDM-930 Main display



Remote Auxiliary Display
(RAD)

Product Features

- Hands-free, automatic scanning
- Lean Find™ finds the first and last cylinder to peak with true peak detect—eliminates false peaks
- Displays both leaned temperature below peak and peak
- Battery voltage with alarm
- Amperes (load or charge/discharge meter)
- Programmable alarm limits
- Exhaust Gas Temperatures (EGTs) to stable 1°F resolution
- DIF low to high EGT with alarm
- Shock cooling monitored on every cylinder
- Fast response probes
- Non-volatile long term memory
- Records and stores data up to 30 hours
- Post-flight data retrieval
- Data retrieval software
- Oil pressure
- Oil temperature
- Turbine inlet temperature, if applicable (optional)
- Outside air temperature
- Compressor discharge temperature (optional)
- Carburetor temperature or induction temperature (optional)
- Fuel pressure, if applicable
- Fuel level Voltage, Resistive or Capacitive (frequency)
- Fuel Flow
 - Solid-state rotor fuel flow transducer
 - Fuel quantity in gallons, kilograms, liters, or pounds
 - Low fuel quantity alarm
 - Low fuel time alarm
 - GPS interface
 - Instantaneous fuel flow rate
 - Total amount of fuel consumed
 - Total fuel remaining
 - Time to empty at the current fuel flow rate
- RPM and manifold pressure
- Automatically calculates percent horsepower
- Hobbs® timer

- Remote Auxiliary Display (RAD)

Section 1 - Getting Started

Important Note!

You **must** have the remote auxiliary display—RAD— installed on the instrument panel of your aircraft. This is required for FAA certification of the EDM-930 as a primary instrument. Upon start up, the RAD displays the make and model of your aircraft, which must be verified before you can rely on the EDM-930 for use as the primary engine instrument cluster. The RAD also will continuously notify you of any alarm conditions, regardless of whether you have cleared them on the EDM-930 display.

This is not an option!

This is a summary of basic operation. Detailed descriptions of all operations appear later in this Pilot's Guide.

EDM-930 primary instruments have preset alarm limits and cautionary ranges (user cannot change them) typically for the following measurements: oil temperature, oil pressure, fuel pressure, fuel quantity, cylinder head temperature, turbine inlet temperature, manifold pressure, and RPM. Your EDM-930 contains a custom Key Card. For Primary configurations, the Key Card activates the primary engine instrument abilities of your engine monitor.

Note: Fuel quantity gauges must be calibrated to the aircraft and will not be functional until the fuel calibration process has been performed.

Display View Angle

The best viewing angle for the pilot is in the horizontal mode with the buttons on the bottom. **Note:** The EDM-930 is to be installed in landscape orientation only and cannot be rotated.

View angles are per the table below:

Viewing angle	Horizontal	Left	65 Degrees
		Right	65 Degrees

List of abbreviations and acronyms

Gauge Function	Message Area Alarm Abbreviation
Primary	Primary
Engine rotational speed	RPM xxxx
Engine Manifold Pressure	MAP xx.x in hg
Engine Cylinder Head Temp	CHT2 xxx °F
Engine Oil Temperature	O-T xxx °F
Engine Oil Pressure	O-P xxx °F
Fuel Pressure	F-P xx PSI
Fuel Flow to engine	F-F xx.x GPH
Comp. Discharge Temp.	CDT xxx °F
Turbine inlet Temp. Left side	TIT-L xxxx °F
Turbine Inlet Temp. Right side	TIT-R xxxx °F
Single Turbine Inlet Temp.	TIT xxxx °F
Non-Primary	Non-Primary
Exhaust Gas Temp.	EGT2 xxxx °F
Shock Cooling of CHT	CLD xx °/MIN
Differential Temp. of EGT	DIF xx °F
Bus Voltage	Volts xx.x
Amperage Load	AMPS xx
Outside Air Temp.	OAT xx °F
Estimated Time to Empty	Est. T to E xx:xx H:M
Fuel used to date	USED xx.x GAL
Estimated Remaining fuel	Est. REM xx GAL
Estimated Fuel required to Waypoint	Est. WP REQ xx GAL
Estimated Fuel Remaining at Waypoint	Est. WP RES xx GAL
Nautical Miles per Gallon	ECON xx.x MPG
Brightness, Dim control	DIM/BRT

Fuel Flow Computer Basics

The fuel flow computer tracks the fuel flowing to the engine and computes various values based on this. At installation, then each time you refuel the aircraft, you must inform the EDM about how much useable fuel is onboard. This is done via the *REFUEL* function. There are three 'Quickset' ways to do this:

1. **Main 74.0 GAL:** MAIN tanks are filled (no other fuel onboard).
2. **Main + Aux 94.0 GAL:** MAIN +AUX tanks are filled.
3. **Adjust? 0.0 GAL:** Partial fuel added to existing quantity.

See page 34 for expanded information on the refueling process.

Control Button Basics

Four operating buttons control all functions of the EDM. These buttons change labels depending on the current state of the EDM..

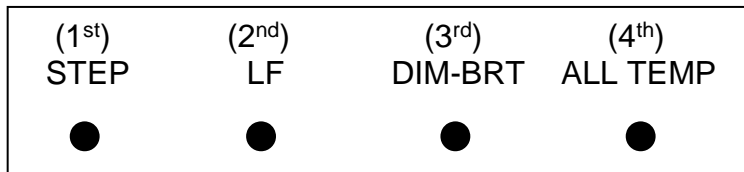

The term *tap* is used to denote pressing a button momentarily. The term *hold* is used to denote pressing and holding a button for five seconds or longer.

Display Screen Basics

The display screen is arranged into three sections. The top left is the *RPM* and *MAP* section. The bottom left is the *Scanner*® section. And the right side is the *Linear Bar Graphs* section. The instrument ranges and alarm limits are configured to match those of your aircraft when the EDM is set up as a Primary instrument.

Remote Auxiliary Display Basics

The Remote Alarm Display '**RAD**' provides alarm display, RPM and MAP, and is located directly in front of the pilot. Upon power up, the RAD shows the Aircraft model, engine type and declares instrument status: 'Primary' (if applicable). Before each flight, confirm that it matches your aircraft requirements.



RPM and MAP Display Basics

The upper half shows the RPM (Revolutions per Minute) and the lower half shows the MAP (Manifold Pressure). Gauge positions are interchangeable during Pilot Programming. Operations exceeding red line causes the digital value to turn red.



Percent horsepower is displayed digitally below and to the left of these two gauges.

Linear Bar Graph Display Basics

The Bar Graphs section contains nine dedicated bar graphs with digital display organized in a three by three matrix. An example is shown here. Pointers move up and down in response to value changes and digital readouts turn red when exceedances occur.

Note: functions displayed in this example may differ from your EDM.

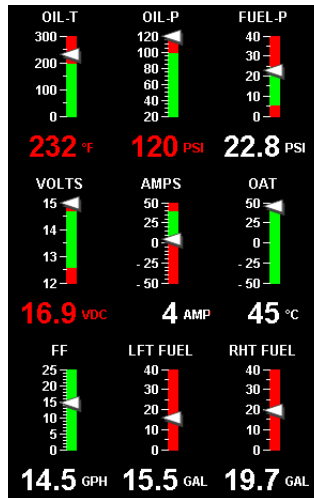

Scanner® Display Basics

The EDM Scanner section is located in the lower left area of the screen. It consists of a graphical display of EGT and CHT (and TIT if so equipped) and a digital display that automatically scans the various parameters. You can select Manual Mode by tapping STEP to lock onto the parameter of interest. To return to Automatic scan mode, tap LF followed by tapping STEP.

Lean Find Basics

Simply pre-lean, then tap the **LF** button (Lean Find) and begin leaning. The EDM will assist you in finding the first cylinder to peak. This example is for Rich of Peak. See page 24 for a more detailed description of leaning.

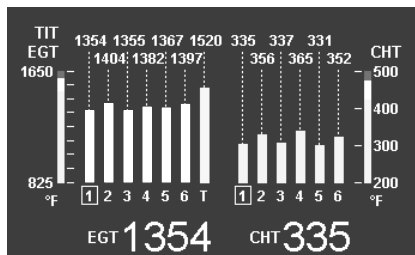

1. Establish cruise at approximately 65 to 75% power and pre-lean the mixture to 50°F estimated rich of peak EGT on any cylinder.
2. Wait about 30 seconds, then tap the **LF** button.
3. Begin leaning the mixture smoothly *without stopping*. Turn a Vernier about ¼ turn per second; retract a non-Vernier or quadrant lever so that EGT rises about 10°F per second.
4. Stop leaning when you see *LEANEST* for two seconds, followed by—for example—EGT 1520 FF 13.8. The left number is the current temperature of the first EGT to peak and the right number is the current fuel flow.
5. Now tap the **PEAK** button to display the EGT difference from peak which is very useful for setting desired degrees below peak. *Note: The value for EGT ROP will be a negative value which means you've gone lean of peak by the time you stopped leaning the mixture.*

6. Slowly enrich the mixture noting that the EGT difference diminishes as EGT climbs back to peak, followed by it going positive again. Stop enriching at the desired EGT difference (such as 'EGT 75').
Note: Please refer to the engine manufacturer's operating guide for the correct value for EGT difference rich of peak operation at 75% and 65%
7. You can also see what the peak EGT was by holding the **PEAK** button.
8. Tap **STEP** to exit the Lean Find Mode.

Section 2 - Interpreting Data

Operation for each Phase of Flight

(worth adding to your run-up checklist)



Engine Run-Up

Suggested setup:

- Set engine to run-up RPM

Normalize view:

- Manual mode

Verify:

- uniform rise of about 50°F in all EGTs in single magneto operation.
- uniform rise of EGTs with application of the mixture control.

Be alert for:

- unusually low voltage (less than nominal battery voltage)
- cold OIL and normal oil pressure
- abnormally high CHT
- large drop in EGT on one cylinder in single magneto operation—may be fouled spark plug.

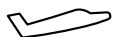

Take-Off, Climb, and Full Throttle Operations

Suggested setup:

- Standard view
- Automatic mode

Verify:

- EGTs and CHTs consistent with past climbs. EGTs should be in the 1100 to 1300°F range (100° to 300°F cooler than cruise) due to fuel cooling.

Be alert for:

- high EGT in one cylinder, 300°F above the others may indicate plugged injector or leaking manifold gasket on a carbureted engine. At high density altitude an overly rich mixture can significantly reduce engine power.
- If all EGT columns go off scale to the top of the column, be sure you are not in Normalize view, as indicated by the symbol NRM above the Scanner® section.



Cruise

After the engine is warmed up, use Lean Find to lean the mixture.

Suggested setup:

- Normalize view
- Automatic mode

Be alert for:

- uneven EGTs (injected engines). Make fine adjustments to throttle, then RPM, then mixture to level the display columns.
- abnormal patterns of EGTs and CHT. (see *Engine Diagnosis Chart* on page 11).



Descent

Suggested setup:

- Standard view
- Manual mode

Be alert for:

- CLD: shock cooling alarm is set to -60°F. Average cool rates of -40°F/minute to -50°F/minute are normal, depending on the engine size.

Typical Normal Measurements

The following chart lists typical *normal* measurement values that you will observe for most general aircraft engines. Your particular engine's ranges may not fall within these values.





<i>Measurement</i>	<i>Normal range</i>	<i>Comments</i>
EGTs in Cruise	1350°F	<ul style="list-style-type: none"> • under 200 HP engines
	1550°F	<ul style="list-style-type: none"> • high performance engines • (EGT should drop 200°F when full throttle is applied)
EGT span (DIF)	70 to 90°F	<ul style="list-style-type: none"> • fuel injected engines
	120 to 150°F	<ul style="list-style-type: none"> • carbureted engines
TIT	1600°F average	<ul style="list-style-type: none"> • 100° higher than EGT
CHTs	350°F (OAT 60°F)	<ul style="list-style-type: none"> • normally aspirated engines
	410°F	<ul style="list-style-type: none"> • Turbocharged engines
CHT span	50 to 70°F	<ul style="list-style-type: none"> • 100° with gasket probes
OIL T	200°F	<ul style="list-style-type: none"> • oil cooler thermostat typically opens at 180°F
OIL P	30 to 60 psi	<ul style="list-style-type: none"> • varies with aircraft type
FUEL P (injected)	14 to 18 psi	<ul style="list-style-type: none"> • varies with aircraft type
FUEL P (carbureted)	0.5 to 8 psi	
Shock cooling*	-40°/minute	<ul style="list-style-type: none"> • tightly cowled engines
	-55°/minute	<ul style="list-style-type: none"> • Bonanza
	-200°/minute	<ul style="list-style-type: none"> • helicopter

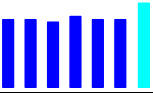
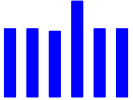
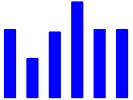
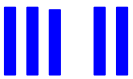
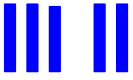

* Maintain a cooling rate magnitude of less than -50°/minute. You will find that the cylinder with the greatest shock cooling may shift from front cylinders (during climb out) to the rear cylinders (during descent).

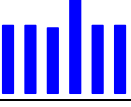
Engine Diagnosis Chart

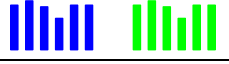
The following chart will help you diagnose engine problems in your aircraft.

<i>Display</i>	<i>Symptom</i>	<i>Probable Cause</i>	<i>Recommended Action</i>
	TIT ~100° higher than EGTs	This is normal	
	75° to 100° EGT rise for one cylinder during flight	Spark plug not firing due to fouling, faulty plug, wire or distributor.	Enrich mixture to return EGT to normal. Have plugs checked.
	EGT Increase or decrease after ignition maintenance	Improper timing: high EGT → retarded ignition; low EGT → advanced ignition.	Check EGT for each magneto to determine any uneven timing.
	Loss of EGT for one cylinder. Engine rough	Stuck valve. Other cylinders are okay.	Have valve train checked.
	Loss of EGT for one cylinder; <i>no digital EGT</i>	Failed probe or failed wire harness.	Swap probes to determine if probe or wire harness is bad.

	Decrease in EGT for one cylinder	Intake valve not opening fully; faulty valve lifter.	Have valve lifter or rocker arm checked.
	Increase in DIF at low RPM	Low compression (blow by) in cylinder	Check compression.
	EGT and CHT not uniform	Normal for carbureted engines. Dirty fuel injectors or fouled plugs.	Check injectors and plugs.
	Decrease in EGT for all cylinders	Decrease in airflow into the induction system. Carb or induction ice.	Check for change in manifold pressure.

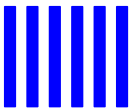
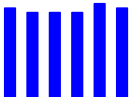
<i>Display</i>	<i>Symptom</i>	<i>Probable Cause</i>	<i>Recommended Action</i>
	Slow rise in EGT. Low CHT	Burned exhaust valve. CHT is low due to low power output.	Have compression checked.
	High CHT on cylinders on one side of engine	Obstruction under cowling.	Check for improper installed baffling, cowl flap misalignment or bird nests.
	Rapid rise in CHT of one cylinder	Detonation.	Reduce power.
	Sudden off scale rise for any or all cylinders	Pre-ignition Normalize view or failed probe	Full rich and reduce power. Change to Standard view Check probe
(no picture)	Loss of peak EGT	Poor ignition or vapor in fuel injection system.	Have magneto tested.
(no picture)	Decrease in peak or flat EGT response to leaning process	Detonation. Usually the result of 80 Octane fuel in 100 Octane engine.	Enrich mixture, reduce power and re-lean mixture. Repeat to find power setting where normal peak is obtained or run rich.
	Below 10,000 ft. full throttle causes EGTs to rise	Weak or defective mechanical fuel pump.	Apply boost pump. If EGTs drop, replace fuel pump.

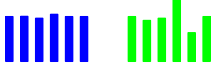
	CHT more than 500°, EGT normal. Adjacent EGT may be low	Leaking exhaust gasket blowing on CHT probe.	Look for white powder around cylinder to determine leak area.
--	---	--	---

Section 3 - Displays and Controls

The EDM monitors engine temperatures, pressures and voltages, assists in adjusting the fuel/air mixture, and helps diagnose engine malfunctions. There are multiple components of the user interface:

- Four front panel operating buttons below the bottom of the display.
- RPM and MAP display in the upper left corner of the display
- Scanner analog display including cylinder number and index square in the lower left corner of the display
- Scanner digital display for numeric readouts and messages at the bottom left
- Bar graph displays on the right half of the display

Control Buttons

(1 st) STEP ●	(2 nd) LF ●	(3 rd) DIM-BRT ●	(4 th) ALL TEMP ●
---------------------------------	-------------------------------	------------------------------------	-------------------------------------

Four operating buttons control all functions of the EDM. These buttons may change labels depending on the current operating mode of the EDM. The term *tap* is used to denote pressing a button momentarily. The term *hold* is used to denote pressing and holding a button for five seconds or longer. Button layout is shown below:

1st Button

- In the Automatic mode, *tapping* the **STEP** button stops Scanner auto-sequencing and changes to Manual mode. Each *tap* of the **STEP** button then displays the next measurement in the sequence. Holding the **STEP** button sequences in reverse order.
- In the Lean Find mode tapping the **EXIT** button will terminate the Lean Find mode and change to the Automatic mode.
- In the Program mode tapping the **NEXT** button will advance to the next item.

2nd Button

- In Automatic or Manual modes, tapping the **LF** button will activate the Lean Find mode.
- In the LF mode holding the **LF** button after peak EGT is found will display the peak EGT.
- In Automatic or Manual modes holding the **LF** button for three seconds will toggle between Standard and Normalize (NRM) views.
- In the programming mode, tapping the **PLUS** or **MINUS** button will allow you to edit a parameter value.
- Holding **LF** during power up will display the primary alarm limits after the self-test is complete.

1st and 2nd Buttons

- Holding both the **STEP** and **LF** buttons simultaneously for five seconds will enter the pilot programming mode.
- Just after entering Lean Find Mode (but before any EGT has risen), holding both First and Second buttons for five seconds will toggle between LOP or ROP leaning modes.
- Tapping both the **STEP** and **LF** buttons simultaneously in Manual mode toggles to 'include' or 'exclude' the displayed non-primary measurement from the Automatic mode. Note: Measurements are never excluded from the Manual mode.

3rd Button

- Tapping **DIM** (brightness decreases) or holding **DIM** (brightness increases) allows decrease or increase brightness respectively.

2nd and 3rd Buttons

- Holding both the **LF** and **DIM** buttons simultaneously will display the Hobbs readings. Tap button labeled **NEXT** to see additional information screens.

4th Button (*ALL, TEMP, FUEL*)

- Select what is shown during Scanner auto-sequence. Choices are **ALL**, **TEMP** or **FUEL**. Highlighted one is what is active.

RPM and MAP Displays

The upper left side of the display shows RPM above the MAP. The arcs represent the analog values. Percent horsepower is shown to the lower left of MAP. Within the FACTORY menu you will be able to swap dial positions for RPM and MAP (see the Quick Reference Guide on page 68).



Scanner Displays

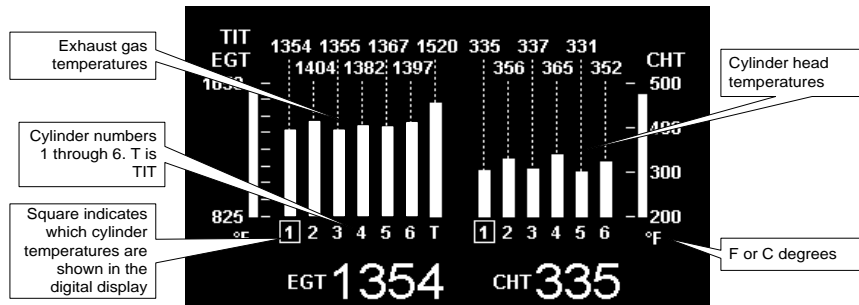

Scanner EGT and CHT Analog Bar Graph

The height of each column represents a EGT or CHT or TIT (if installed) temperature. The graph resolution depends on the programmed span between the top and bottom of the range marks. Note: when in certain modes, such as leaning or normalize, the EGT resolution will temporarily be finer.

Cylinder Numbers and Index

Just below the bar graph columns are numbers identifying the respective cylinder. If TIT is installed, it is labeled by the letter **T** underneath. A square 'Cylinder I.D. Index' surrounding a number indicates what cylinder is currently selected and relates to the digital display.

Scanner Digital Display

Located under the Scanner bar graph area is the alphanumeric display. It displays alphanumeric values for different parameters as well as status and alarm messages.

Normalize / Standard View

To toggle between Standard and the Normalize views, hold the **LF** button for three seconds until the **NRM** icon toggles on or off. Note: Normalize cannot be activated while in Lean Find mode.

- **Standard view** (when the **NRM** icon is *not* lighted): the EGT represent absolute temperature. The top of the columns indicate absolute temperature relative to the adjacent range mark temperature scale. A maximum height column depicts the temperature at the top of the range mark scale (or more), while no column represents the temperature at bottom of the range mark scale(or less). The *Standard view* permits comparison of EGTs *across all* cylinders.
- **Normalize view** (when the **NRM** icon is lighted): the EGT represent the difference in temperature from the mid-point of the range mark scale. When you change to the Normalize view, all EGT columns are initially normalized to the mid-point for deviation trend analysis. Any changes are shown as an increase or decrease relative to the mid-point, thus giving an instantaneous indication that an EGT has deviated. You normally use normalize in level cruise, but it is also useful during steady state run-ups. Note: A common misapplication is to be in the Normalize view and then change power setting. This causes all columns to go off scale, high or low. Select Standard view before changing power or altitude.

Temperature Units (°F or °C)

The EDM can display engine temps in either °F or °C (Fahrenheit or Celsius). In Primary configurations where the POH has both °F or °C the unit can be configured either way.

Linear Bar Graph Displays

The linear bar graphs are arranged in a three by three matrix on the right half of the display. A typical layout is depicted here (Note: your actual configuration may vary). Typical functions that can be displayed are:

- Oil temperature
- Oil pressure
- Fuel pressure
- Bus voltage
- Amps (charge/discharge shown)
- OAT
- Fuel flow
- Left tank fuel quantity *
- Right tank fuel quantity *

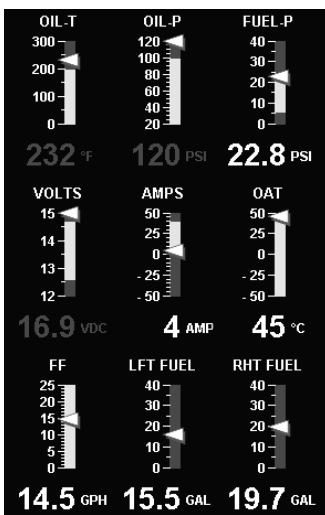

* The fuel quantity gauges will not be functional until the fuel calibration process has been completed.

The range of the bar graphs depends on the programming. Range, redlines and/or limits are typically set to match the original aircrafts gauge markings. These are locked for Primary installations, however non-primary gauges can be user modified, using 'EDM Config' which is currently available through the front panel buttons. Editing of Gauge Layout requires EDM Software version 1.20.489 or later. Note: Amps can operate either as a charge/discharge or load meter, depending on programming. For charge/discharge, the center of the bar is zero and the top and bottom are maximum charge and discharge, respectively.

Remote Auxiliary Display

See the important note on page 1 regarding the RAD.



The remote auxiliary display 'RAD' provides redundancy and allows positioning a smaller display directly in front of the pilot. Upon power up the RAD displays the EDM's programmed configuration (aircraft make and model and primary status). Confirm that it matches your aircraft configuration before using the instrument. This auxiliary display will normally show RPM and MAP, but will display a blinking alarm message, duplicating the alarm indication of the EDM. For example, low calculated fuel remaining of 7.7 gallons would show:



Hobbs Display

Holding both the **LF** and **DIM** buttons simultaneously will display the Hobbs times similar to the example below:

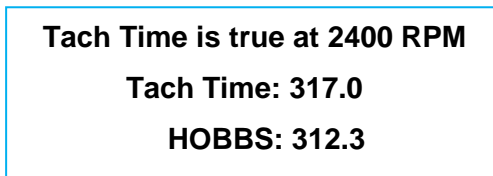

Dimming the Display

Automatic dimming is provided to dim both the panel display and the remote alarm display. You can manually adjust brightness by tapping the DIM-BRT button and using DIM to decrease brightness or BRT to increase brightness of the display.

Section 4 - Operating Modes

The EDM has four basic operating modes: *Automatic*, *Manual*, *Program* and *Lean Find*. Lean Find is described in the next section; Program mode is described on page 449, 'First Time Setup and Customization'. When you first turn on the power the EDM starts in the Manual mode, but will enter the Automatic mode after a few minutes. The Automatic mode provides you with engine monitoring information for the majority of flight conditions. To optimize the mixture, use the Lean Find mode. To display specific parameters, use the Manual mode. In either Automatic or Manual modes, the display always shows the Scanner bar graphs for EGT and CHT for each cylinder and TIT (if so equipped).

Automatic Mode

To activate Automatic Scanner Mode, just tap the LF button, then tap the STEP button. In the Automatic mode the EDM changes which measurement is displayed every four seconds (factory default is 'Auto Scan Rate 4'), however you can change this rate in the Program Mode. A setting of zero disables auto scanning altogether.

Some non-primary measurements can be excluded from the *Automatic mode*: tap STEP to enter the Manual mode. Tap STEP repeatedly to index to the measurement you want to exclude. Then tap both the STEP and LF buttons simultaneously. Excluded measurements display a decimal point before the measurement name. For example:

Included: 1540 CDT Excluded: 1540 •CDT



Tapping the STEP and LF buttons simultaneously will toggle back and forth between *include* and *exclude*. Note: All measurements are always checked for alarm conditions every second.

- Every time you turn on the EDM, all measurements are reset to be *included*.
- All installed measurements are always displayed in the Manual mode. Exclusion only applies to the Automatic mode.

Manual Mode

To activate Manual Mode, just tap the **STEP** button. Use the Manual mode when you want to lock on one specific measurement such as shock cooling during descent, or your hottest CHT during climbs. To select the desired parameter, tap the STEP button until it appears. To return to the Automatic mode, tap the LF button and then tap the STEP button. You may completely disable the Automatic mode by setting zero for 'Auto Scan Rate 4'. See Pilot Programming.

Scan Sequence Example

<i>Measurement</i>	<i>EXAMPLE</i>	<i>COMMENTS</i>
EGT, CHT	EGT 1354 CHT 335	Square indicates the cylinder being viewed
TIT	1370 TIT	Turbine Inlet Temperature # 1
Shock Cooling	-30 CLD	Square indicates fastest cooling cylinder
Compressor Discharge Temperature	300 CDT	Temperature into intercooler
Induction Air Temperature	125 IAT	Temperature out of the intercooler
Carburetor Temperature	-22 CRB	(Not available when CDT is installed)
Difference between hottest and coldest EGT	80 DIF	Square indicates most widely deviating cylinder
Fuel Remaining	Calculated 37.2 REM	In gallons, liters, pounds or kilograms

Fuel required to next GPS WPT or Destination	25.9 REQ	Present with GPS interface, valid signal and way point
Fuel Reserve at next GPS WPT or Destination	Calculated 11.3 RES	Present with GPS interface, valid signal and way point
Nautical Miles per Gal	13.0 MPG	Present with GPS interface and valid signal. MPK, MPL, MPP for dif units
Time to Empty	Calculated 02:45 H:M	Hours: minutes calculated remaining at current fuel burn.
Total Fuel Used	38 USD	Since last refueling or trip total.

Section 5 - Lean Find

The EDM supports two methods of leaning; **ROP** (Rich Of Peak) and **LOP** (Lean Of Peak). Note: on power-up, the unit defaults to Rich Of Peak mode, but is easily changed to Lean Of Peak mode. During traditional Rich Of Peak leaning, you'll finalize the mixture to about 20° to 80° rich of peak (depending on engine operating requirements). However, with the advent of closely balanced injectors (such as GAMI), it is possible to set the mixture lean of peak—thus saving fuel and running the engine cooler. Both Rich Of Peak and Lean Of Peak processes are described in detail in this manual.

Upon reaching cruise configuration, use the Lean Find mode to identify the correct cylinder to reach peak EGT (for Rich Of Peak this is the **FIRST** to peak, for Lean Of Peak this is the **LAST** to peak). To change from one method to the other, right after activating Lean Find, hold **STEP** and **LF** and the other method will be momentarily shown: **ROP** (Rich Of Peak) or **LOP** (Lean Of Peak). Release buttons after the other method appears. Within the **FACTORY** menu you will be able to default to LOP operation as your lean find mode (see the Quick Reference Guide on page 68).

The illustration below shows the various relationships between the mixture, fuel flow and engine power:

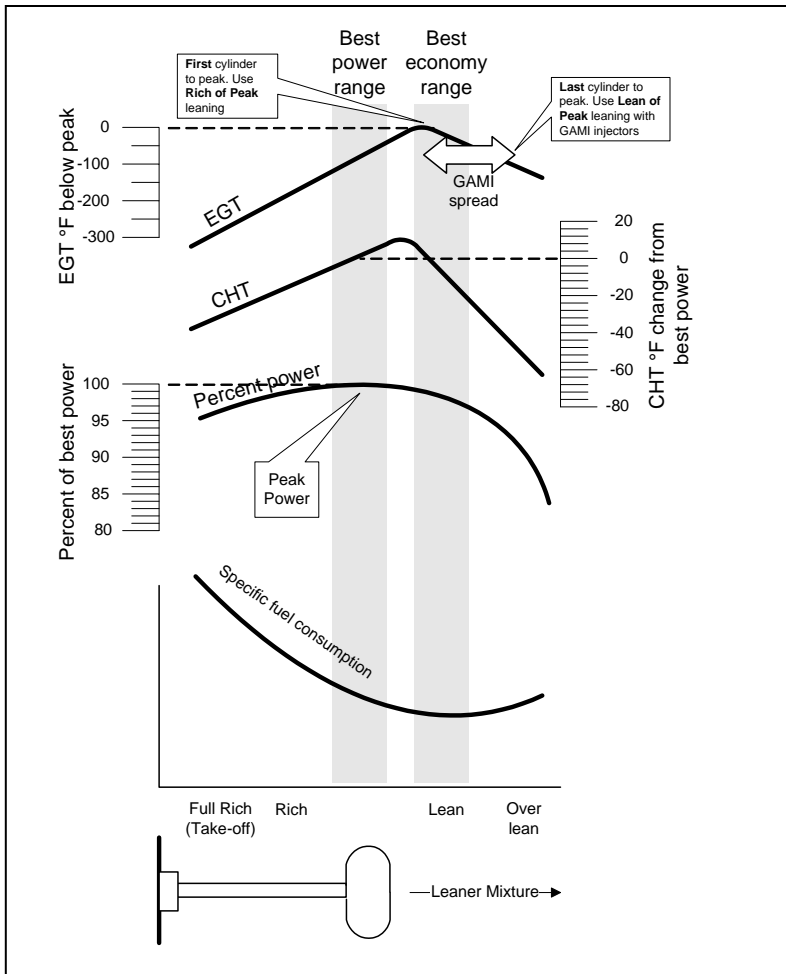

The following pages provide step by step guidelines in leaning your engine, for both rich of peak and lean of peak modes:

Rich of Peak leaning is as simple as:

- A. Pre-lean your mixture.
- B. Tap the LF button (verify *ROP* appears).
- C. Lean mixture until *LEANEST* flashes (peak found).
- D. Enrichen to the desired value 'Rich Of Peak'.

R	Procedure	Scanner Example	Comments
1	Establish cruise at 65 to 75% power.		
2	Pre-lean the mixture to 50°F estimated rich of peak on any EGT: _____°F.	EGT <i>1490</i> CHT <i>370</i>	* See 'Pre-leaning' page 23.
3	Wait one minute		Let engine stabilize.
4	Tap the LF button	ROP	Start Lean Find (if <i>LOP</i> appears hold STEP & LF until <i>ROP</i> appears)
5	Lean the mixture at approx. 10°/second <i>without</i> pausing.	EGT <i>1520</i> FF <i>13.8</i>	Flashing cylinder I.D. box identifies that EGT increased at least 15°F. EDM is now looking for first EGT to peak.
6	Stop leaning when a column begins flashing. You will see <i>LEANEST</i> for one second, followed by:	EGT <i>1545</i> FF <i>12.4</i>	Flashing cylinder I.D. box <i>AND</i> its column indicates leanest cylinder. Due to thermal inertia this will usually be about -15°F down the lean side of peak.

7	If you hold PEAK, the values of EGT and FF when peak was found are displayed.	EGT ↑ 1560 FF 12.9	Captured peak EGT value and peak FF are displayed.
8	If you tap PEAK, the difference from peak EGT is shown. Tap again to return to the peaked EGT value.	EGTΔ -90 FF 13.4	A useful mode for setting mixture the desired degrees rich of peak - no math required! NOTE: Unit remembers view last used.
9	Slowly enrich the mixture noting that EGT is returning to peak. Stop enriching at the desired EGT. 'Peak': best Econ. 'ROP' target: best power.	EGT 1560 FF 12.9 EGT 1460 FF 13.6 (100° RICH OF PEAK)	

Lean of Peak leaning is as simple as:

- A. Pre-lean your mixture.
- B. Tap the LF button (verify *LOP* appears).
- C. Lean mixture until *RICHEST* flashes (peak found).
- D. Enrichen to the desired value 'Lean Of Peak'.

L	Procedure	Scanner Example	Comments
1	Establish cruise at 65 to 75% power.		
2	Pre-lean the mixture to 50°F estimated rich of peak on any EGT: _____°F.	EGT 1490 CHT 370	* See 'Pre-leaning' page 23.
3	Wait one minute		Let engine stabilize.
4	Tap the LF button	LOP	Start Lean Find (if <i>ROP</i> appears, hold STEP & LF until <i>LOP</i> appears)
5	Lean the mixture at approx. 10°/second <i>without</i> pausing. (cylinder I.D. box flashes when a EGT rises 15°F)	EGT 1520 FF 13.8	Flashing cylinder I.D. box identifies the hottest EGT and that an EGT has increased at least 15°F which arms the EDM to now look for first EGT to peak.
6	After the first EGT peaks, you will see LEANEST for one second and bars coming from the top down. Continue leaning.	EGTΔ -17 FF 12.4	When bars come from the top down, the cylinder I.D. box identifies the first EGT that peaked (leanest). Continue leaning.
7	When RICHEST appears, fine tune the delta EGT to the desired degrees below 'Peak' (Lean of peak).	EGTΔ -45 FF 11.6	
8	If you hold PEAK, the peak EGT recorded will be displayed along with FF spread.	EGT↑ 1560 FFΔ 0.6	Captured peak EGT value and the FF spread between richest and leanest cylinders.

Lean Find Procedure—General Explanation

Lycoming and Continental established specific restrictions on leaning that must be followed, such as percent power, climb leaning, and TIT limits. Lycoming recommends operation at peak of EGT at 75% or less power only. Continental recommends operation at peak EGT at 65% or less power only. This guide does not supersede specific recommendations of the engine or airframe manufacturer. **It is your responsibility to know your aircraft's limitations.**

Pre-leaning: The leaning process typically begins with 'pre-leaning' by leaning the mixture until you see the hottest cylinder peak. (note: you can optionally activate 'Normalize' - hold LF until **NRM** appears - making it easier to confirm all EGT's decrease). After finding peak EGT, enrichen the mixture to achieve a 50° drop on the hottest EGT. Ensure that all EGT's decrease. Wait one minute to allow temperatures to stabilize.

Lean Find-Initiation: The leaning process typically begins with 'pre-leaning' to insure all cylinders are operating rich of peak EGT. This is accomplished as follows. As you lean the mixture watch the hottest EGT and note when it begins to decrease in temperature. Now enrichen the mixture to achieve a 50° drop on the hottest EGT. Insure that all EGT's decrease. Wait one minute to allow temperatures to stabilize. *Note: When the first EGT peaks, you can optionally activate 'Normalize' - hold LF until NRM appears - making it easier to confirm that all EGT's decrease.*

Lean Find-Initiation: Initiate the EDM leaning mode by tapping the **LF** button. *Note that the EDM displays its current leaning mode momentarily: ‘ROP’ for operating Rich of Peak or ‘LOP’ for operating Lean of Peak.* To change, simply tap the LF button which should read ROP or LOP depending on which has been set as default. The display will show the other mode. The EDM is now waiting for a 15° rise on any EGT (this feature significantly reduces false peaks). Lean the mixture *without pausing* to achieve about a 10 deg per second change. With the Vernier mixture control, turn the knob about a quarter turn every second. With the non-Vernier or quadrant mixture control, lean slowly and smoothly about 1/16 inch every five seconds (note: leaning accurately with a quadrant system is difficult due to its mechanical linkage).

Lean Find-Activation: When a 15° EGT rise occurs, Lean Find activates (indicated by a cylinder I.D. box flashing over the number of the hottest EGT). **Remember: The Lean Find mode is not active until a cylinder I.D. box is flashing.** To show the progress of the leaning process, the EDM now displays the hottest EGT in the left side of the digital display and the fuel flow in the right side. This information allows you to observe the EGT behavior throughout the leaning process.

Lean Find-Rich Of Peak Detection: Eventually, one cylinder will reach peak before any of the other cylinders. The EDM will determine this automatically. The EDM will indicate success in finding a peak by displaying the word **LEANEST** for two seconds and flashing its corresponding Cylinder I.D. Box. The *Scanner*® Information Area will also display the current value for the peaked EGT on the left, and the fuel flow value on the right, for final adjustment of the mixture. The peak EGT value and FF value encountered during leaning is remembered by the EDM and can be displayed by holding the PEAK button during Lean Find Mode.

Lean Find-Finalizing the Rich Of Peak Mixture: You may now enrich the mixture to operate at peak or continue enriching to a value of your choice (typically between 50 to 100° rich of peak for best power), consistent with the procedures defined in your aircraft and/or engine manual. Note: tap PEAK to see the current difference from the peak temperature. This is handy for finalizing mixture. Tapping EXIT exits the lean find mode and automatic scanning resumes.

Peak Detected - Rich Of Peak Mode

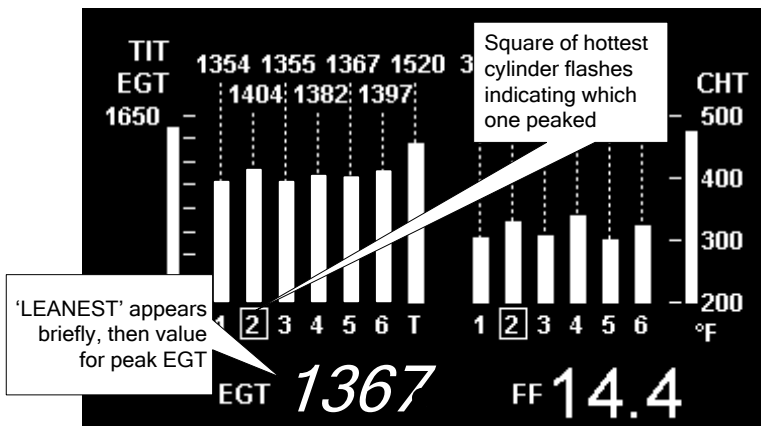

Lean Find-Lean Of Peak Detection: Note: This mode should only be used when your engine is equipped with balanced fuel injectors. When using the Lean of Peak mode, you lean until *all* EGT's decrease slightly below their respective peaks. The EDM has automatic peak detection and will sequentially indicate leaning progress. When the first EGT peaks, the word **LEANEST** appears and the cylinder I.D. box highlights the cylinder number. Each column successively drops as leaning continues. When the last column drops (last EGT peaks), **RICHEST** appears and its respective column flashes momentarily. The last EGT to peak is the one you will use when setting the final mixture.

Lean Find-Finalizing the Lean Of Peak Mixture: The *Scanner*® Information Area displays the degrees below peak for the **last** (or richest) EGT to peak, giving you precise information necessary in setting the final mixture. Adjust the mixture to achieve the desired value below peak (using the digital EGT readout) or before engine roughness occurs. Caution: do not lean to the point where the engine runs rough. Note: the peak EGT value encountered during leaning can be recalled by holding the PEAK button. Tapping STEP exits the lean find mode and automatic scanning resumes.

Peak Detected - Lean Of Peak Mode

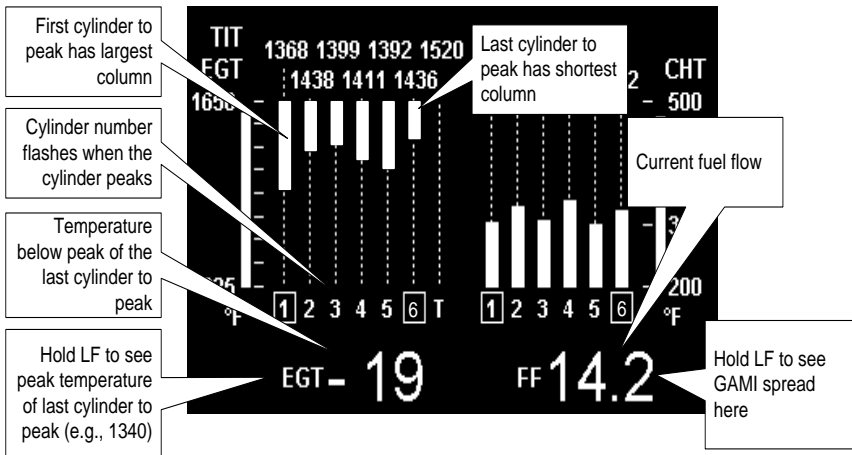

Expanded Leaning Procedures

Lean Of Peak mode: During the ‘lean of peak’ process, the EDM hunts for the last cylinder to peak. Ultimately, you want to have ALL cylinders operating on the lean side of peak. You will final adjust your mixture to this cylinder. To provide a unique graphical depiction during lean of peak operation, the columns become inverted after the first EGT goes just beyond peak. Each EGT column then originates from the top of the display and drops downward. As each subsequent EGT goes past peak, its column will begin falling. The columns length depicts how far the EGT has dropped below its original peak. In this mode, each segment is **5° F**. You will continue to lean until the last EGT peaks note: never lean to the point where the engine is running rough). When the last EGT peaks, its column will flash and **RICHEST** appears. The digital readout will show the current temperature difference from where peak EGT occurred and the current fuel flow (if so equipped). Note: holding the **PEAK** button will show the captured peak value of the ‘last EGT to peak’ and also the difference in fuel flow between the first and last to peak (known as the GAMI Spread). This is a good indication of injector balance (the smaller the FF difference, the better the balance). Tapping **STEP** exits the lean find mode and automatic scanning resumes.

Leaning Turbocharged Engines: *The leaning process for turbocharged engines is by reference to the first EGT or TIT to reach peak. Therefore you should use the Rich Of Peak mode. The factory TIT red line (typically 1650°F to 1750°F) may limit the leaning process, depending on flight conditions. If TIT exceeds red line (but not by more than 99°), the EDM will allow you to continue leaning for one minute before a TIT alarm activates. NOTE: TIT can read approximately 100°F hotter than the hottest EGT due to unburned fuel in the exhaust igniting and is not necessarily abnormal behavior. The reduced size of the JPI Hastaloy-X-tip probes produce faster response and are more accurate than the massive factory installed probes. Therefore a JPI probe may read as much as 100°F higher than the factory installed probe. However, the certified factory-installed gauge must be obeyed as the limiting factor when adjusting your engine.*

Section 6 - Fuel Flow Operation

Fuel Management

Without a means of measuring accurate fuel flow, you must rely on the aircraft fuel gauges or total time of flight. Aircraft fuel gauges are notoriously inaccurate (they are only required by the FAA to read accurately when displaying *empty*). Determining fuel consumption by multiplying time of flight by estimated flow rate is, at best, an approximation, and assumes a constant fuel flow rate for each phase of flight. However, the EDM Fuel Flow Option uses a small, turbine transducer that measures the fuel flowing into the engine. Higher fuel flow causes the transducer turbine to rotate faster which generates a faster pulse rate. Because the transducer turbine generates thousands of pulses per gallon of fuel, it can measure with high resolution the amount of fuel that flows into the engine. Prior to engine start you inform the EDM Fuel Flow Computer system of the known quantity of fuel onboard, it then subsequently tracks all fuel delivered to the engine.

IMPORTANT !

For EDM fuel calculations to be accurate, it is mandatory that you inform the EDM of the correct amount of usable fuel onboard the aircraft and confirm proper operation of the fuel flow transducer prior to and during flight. Do not rely on fuel flow instruments to determine fuel levels in tanks. Refer to original fuel flow documentation for primary fuel management information.

Start Up Fuel

On power-up, you will be prompted to enter any fuel you might have added to the aircraft (this process updates the **REM** and **USD** values). The EDM will flash **REFUEL?**. If you didn't add any fuel, simply tap EXIT to quit, otherwise tap NEXT to pick one of the three quickset choices below:

Choice 1) **MAIN 66.0 GAL** : Tap SAVE to accept or NEXT for choice #2. This shortcut sets **REM** to the MAIN tank value (66 in this case) you set up in your fuel computer.

Choice 2) **MAIN + AUX 82.0 GAL** : Tap SAVE to accept or NEXT for choice #3. This shortcut sets **REM** to the sum of MAIN and AUX you set up in your fuel computer.

Choice 3) **Adjust? + 0.0 GAL** : Tap either ADD or REMOVE to adjust **REM**. Use when adding a partial amount of fuel. Tap SAVE to accept adjustment or NEXT to repeat **REFUEL?**.

NOTE: If you forgot to perform your EDM REFUEL before starting the engine, it can still be performed. The EDM will automatically subtract any burned fuel from the value you choose (not applicable to the 'Adjust? + 0.0' feature)

You are responsible for insuring that your usage of the REFUEL feature results in the EDM's REM parameter showing the correct amount of usable fuel remaining onboard the aircraft.

The three examples, shown below, depict different aircraft tank configurations and how you can update your EDM after refueling your aircraft. These are meant to be general guidelines.

Example A: Aircraft has two fuel tanks with internal tabs.

You've preset: **'MAIN = 66'** (33 + 33 usable)

'AUX = 16' (8 + 8 usable)

When you refuel:

'MAIN 66.0 GAL': use this shortcut when filling to the internal tank tabs.

'MAIN+AUX 82.0 GAL': use this shortcut when filling to the caps.

(only one tank is shown in each of the two scenarios)

MAIN 66.0 GAL

'FILL 66'

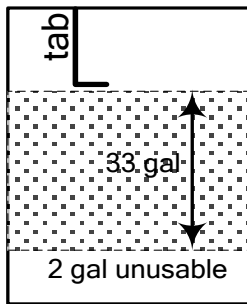

MAIN+AUX 82.0 GAL

'FILL 82'

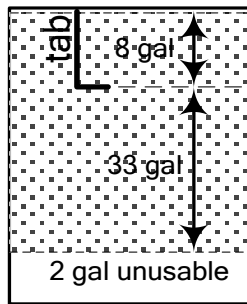

Example B: Aircraft has two MAIN and two AUX tanks.

You've preset: **'MAIN = 60'** (30 + 30 usable)

'AUX = 14' (7 + 7 usable)

When you refuel:

'MAIN 60 GAL': use this shortcut when filling only MAIN tanks
(! AUX tanks must be empty).

'MAIN+AUX 74 GAL': use this shortcut when filling MAIN and AUX tanks.

(only one wing shown in each of the two scenarios)

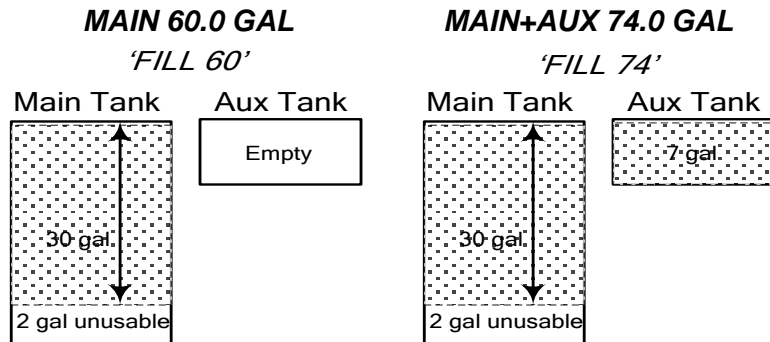

Example C: Aircraft has two MAIN tanks.

When you partially refuel, use:

'Adjust? + 0.0 GAL': use this to add the amount of fuel you pumped into the aircraft (it doesn't matter which tanks you added to - the EDM totalizes ALL onboard usable fuel). In this example you will add **'+ 14.0 GAL'**, the same as your fuel slip reads. This will be added to the totalizer REM value.

Adjust? + 14.0 GAL
'FILL +'

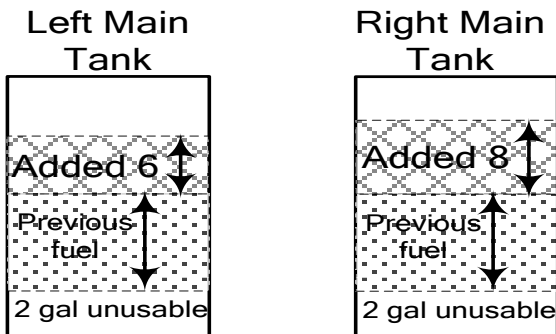

Resetting 'USD'

USD is automatically reset whenever you perform **REFUEL** on your EDM (except if TRIP mode = yes).

After filling your tanks and prior to engine start you should inform the EDM that the aircraft has been filled. In this case **USD** is automatically set to zero.

If you forgot and have already started the engine, and then you inform the EDM that tanks have been filled, then some fuel has already been used. Not to worry as the EDM will automatically set **USD** to this amount and also subtract it from the **REM** value, keeping the two values in balance.

To manually zero the amount of fuel USD at any time, manually **STEP** to display **USD** and then hold both DIM (button 3) and ALL TEMP (button 4) until the display shows '**.0 USD**' (this normally takes about five seconds).

Trip Mode (Accumulate Trip Totalizer)

Trip mode is typically used if you want to track the total fuel used over a multi-stop cross country. To have the **USD** parameter continuously accumulate total consumed fuel, set **TRIP?** **Y**. 'Trip Mode' is described in the 'Program Mode section'. Note: typically, **TRIP?** is set to '**N**' so that **USD** will be reset every time you fuel the aircraft.

Scanner Fuel Flow Display Select

Button four selects three different Scanner filters - ALL, TEMP or FUEL. Tapping this button will select the next choice shown.

- **ALL TEMP:** all installed parameters are shown in Scanner.
- **TEMP FUEL:** only the installed temperature (and battery voltage) parameters are shown in Scanner.
- **FUEL ALL:** only fuel flow parameters are shown in Scanner.

Note: Scanner filter or mode selection does not affect Alarms or analog displays.

Section 7 - Alarms

Whenever a measured parameter falls outside of the normal allowed operating limits, i.e. goes beyond redline, the main display will blink an alert icon. This consists of the current digital value and a flashing red label in the Scanner area and the RAD. For example, if CHT 2 is at 480, and redline is 460, the alert would be displayed as *480 HI CHT2*. Other alarm examples are:

2780 HI RPM, 15 LO OIL-PSI, 240 HI OIL-TEMP.

Tapping the CLEAR button extinguishes the alert for ten minutes whereas holding the CLEAR button turns the alarm off for the remainder of the flight.

Primary alarm *limits* for each specific aircraft model are set by JPI in accordance with the Pilot Operating Handbook and/or TCDS and are not programmable by the pilot. These typically include some or all of the following measurements: CHT, CDT, O-T, O-P, F-P, GAL LEFT, GAL RIGHT, MAP, RPM, FF, IAT, CRB, and TIT. To view the alarm limits screen, hold button 2 during power up (or hold both buttons 2 & 3 during normal operation), tap NEXT until the list is displayed.

The primary functions for your installation are shown on the Primary label on the back of the instrument and are identical to those specified in the FAA Approved Airplane Flight Manual/Pilot's Operating Handbook.

Non-primary Alarm Priority

Primary alarms will always have precedence over non-primary alarms. The typical non-primary alarm priorities are as follows:

HighestLowest

MIN → REM → DIF → CLD → BUS H → BUS L → AMP

Section 8 - Memory and Data Download

The EDM compresses and records **all** displayed parameters once every **six seconds (default)** in Long Term Data Memory (note: you can change this rate to be 2 to 500 seconds). This data is retrievable by inserting a USB Drive into the jack on the front of the instrument and following the prompts. You can choose to retrieve '**ALL**' the data stored in the EDM, or only the '**NEW**' data recorded since your last retrieval. In either case, the selected data in the EDM is not erased. The data can later be viewed on EZTrends2, a PC program available from JPI or over the internet.

Recording typically begins when EGTs are greater than 500°F or RPM is greater than 500. The amount of data that the EDM can store will vary depending on how rapidly parameters change. The typical storage capacity is greater than 100 hours at a 6 second recording interval, but can vary depending on configuration. When the memory becomes full, the oldest data will be discarded to make room for the newest. All data are time-stamped. The EDM contains a real-time clock that may be set when you initially program your instrument. You may change the recording interval from 2 to 500 seconds, even in flight (when you change the interval in flight, the current flight file is closed and a new flight file is started at the new interval).

Downloading Data from the EDM

Downloading is a simple process. Follow the steps below:

- a. With the EDM powered up, plug the USB flash drive into the EDM USB port.
- b. Wait for the EDM display to show *DOWNLOAD: NEW*.
- c. To download only the new data since the last download, tap the **STEP** button.
- d. To download all data in the EDM, tap the **CHANGE** button to see *DOWNLOAD: ALL*, then tap **STEP**.
- e. You will see a 'progress indicator' as the data is copied to the USB flash drive. **DO NOT INTERRUPT THIS PROCESS**. When the download is complete the display on the EDM will show **DONE** and then return to normal operation.
- f. Wait until the process is complete then remove the USB flash drive from the USB connector.

Transferring data from the USB Flash Drive to a PC

To transfer your data from the USB flash drive to your PC, follow these easy steps.

1. On your PC, start the EzTrends2 program.
2. Plug in the USB flash drive into an available USB port.
3. In EzTrends2, select the Move and Plot Data from Memory Stick option.
4. In the displayed list, find the USB flash drive and double click it.
5. Select the file you wish to plot and then select the flight in that file.

Refer to the EzTrends2 manual for details on how to use EzTrends2.

Section 9 - First Time Setup and Customization

Your EDM comes with most settings programmed. However some settings you will fine tune to your installation and/or preferences. We recommend you perform the following minimum set up:

1. Pilot Programming Mode:

- Set the GPS Communications format to match your type of GPS.
- Fine tuning of fuel flow K-factor is important as it affects your fuel computer parameter accuracies.
- Set the Engine HP equal to your engines rated horsepower.
- Perform the HP Constant set up for best accuracy of the Percent Horsepower readout.
- Optionally fine tune other parameters such as MAP, OAT.

2. EDM Screen Customization

Use 'EDM Config' to customize your EDM. All EDM930 and EDM960 units manufactured after Sep 15, 2012 have the EDM Configuration Editor built into a separate utility memory area of the EDM. *Note: Please refer to EDM Config Editor page 64.*

To start the EDM Configuration Editor, hold the left two EDM buttons (STEP & LF) while powering up the EDM. This will start the EDM in a special **App Loader** mode. Once the EDM Configuration Editor program is found, a button will be labeled **CFG EDITOR**. Press the button to run the EDM Configuration Editor program.

When EDM Configuration Editor starts, it will show a startup screen titled **EDM960 Configuration Editor** or **EDM930 Configuration Editor** that lists the version information for the Editor.

3. Fuel Level Calibration

- Fuel Level calibration must be performed before the fuel level feature will function.
- Collect your calibration data for various fuel tank levels (called points) by putting the EDM into the 'Fuel Level Readings' mode. Carefully review readings during the process to insure the calibration data is sensible, correct and useable. *Note: Please refer to the installation manual for accessing fuel tables and calibration on page 22 item 24.4.*
- Enter the data by putting the EDM into 'Fuel Table Data' mode and enter your values into each tanks chart.

Pilot Programming Mode

To start Pilot Program Mode, hold both **STEP** and **LF** buttons until you see **PROGRAM** for two seconds. Then tap the **NEXT** button to advance to the desired item in the list. Hold the **NEXT** button to back up in the list. Either tap **NEXT** until you see **END?** Tap **YES** to end which saves changes and restarts the unit. Tap **NO** which goes back to the beginning of the **PROGRAM** mode. Tap **FACTORY** to go to the **FACTORY** programming menu.

<i>First button advances to NEXT item</i>	<i>Third and Fourth buttons selects values</i>	<i>Comments</i>
PROGRAM Mode		Stays on for two seconds.
Refuel?		Tap REFUEL to change fuel status. Exits program mode when done.
Auto Scan Rate 4	0 ⇔ 9	Scan rate (seconds between parameters) in the Automatic Mode. 0 disables the Automatic Mode.
Trip Used? No	NO ⇔ YES	NO : When Refuel mode used on EDM, total fuel used is reset to 0. YES : accumulate total fuel used rather than reset to 0 at each refueling. See page 48.
EGT Display in 1's	1's 10's	Tapping 1's sets the digital display to one-degree resolution; tapping 10's sets 10° (10° resolution is easier to interpret the EGTs).

OAT Display °F	F ⇄ C	Tap C to display OAT in Celsius, F to display in Fahrenheit. Hold NEXT and button 2 for 5 seconds to adjust the OAT.
OAT Adjustment 0	-10 ⇄ +10	Adjust the indicated temperature up or down by up to 10° using PLUS or MINUS . For example, OAT+3 adjust the OAT 3° higher.
HP Constant= 125	10 ⇄999	Hold NEXT and button 2 until you see ADJUST . Tap PLUS or MINUS to adjust (%HP display will reflect changes). Hold NEXT and button 2 to save changes.
Map Adjustment +0.0	-3.0 ⇄ +3.0	Correct the MAP to the altimeter setting at a sea level airport ±3.0 inHg. Hold NEXT and button 2 for 5 seconds until you see ADJUST . Use PLUS or MINUS to adjust. Hold NEXT and button 2 to save changes. Tap NEXT to skip to next item..
K-Factor 1 29.90	00.10 ⇄ 99.99	Set the instrument's K-factor to match the fuel flow transducer K-factor and performance. Hold NEXT and button 2 for 5 seconds until you see ADJUST . Use DIGIT , PLUS or MINUS to adjust. Hold DIGIT and button 2 to save changes.
K-Factor 2	00.10 ⇄ 99.99	Applies only to pressurized carburetors.
CARB? N	YES or NO	Select YES or NO and hit NEXT to go to the next item..
GPS Format = 6	0 ⇄8	Adjust to set the GPS Communications format. Hold NEXT and button 2 for 5 seconds until you see ADJUST . Use PLUS or MINUS to adjust. Tap SAVE to save changes. Tap NEXT to skip to next item. See page 57.

Time: 18:23:59	00:00:00 ⇔ 23:59:59	Hold NEXT and button 2 for 5 seconds until you see ADJUST . Use Hours, Minutes, Seconds to adjust. Tap SAVE to save changes. Tap NEXT to skip to next item.
Date: 05/14/09	01/01/00 ⇔ 12/31/99	Hold NEXT and button 2 for 5 seconds until you see ADJUST . Use Month, Day, Year to adjust. Tap SAVE to save changes. Tap NEXT to skip to next item.
RECORD TIME: 6	1 ⇔ 481 sec.	Use PLUS or MINUS to adjust. Tap NEXT to skip to the next item.

END?	NO , YES or FACTORY	YES exits the pilot program mode. NO reenters pilot program mode. FACTORY gets you to the Factory programming mode.
FACTORY Mode		Stays on for two seconds.
FUEL UNITS: GAL	Hold buttons 1 and 2 to enter the change fuel units function.	Default unit is GAL. Tap CHANGE to choose a different unit. Hold buttons 1 and 2 to Save the new fuel unit.
MAIN TANK SIZE =	0 ⇔ 999 gal.	In gallons or preset value. Use PLUS or MINUS to adjust. Tap NEXT to skip to the next item.
AUX TANK SIZE =	0 ⇔ 240 gal.	In gallons or preset value. Use PLUS or MINUS to adjust. Tap NEXT to skip to the next item.
FUEL USD REMINDER	0 ⇔ 500 gal.	In gallons or preset value. Use PLUS or MINUS to adjust. Tap NEXT to skip to the next item.
REMINDER TIMEOUT = 5	0 ⇔ 60 min.	Sets duration on display in minutes. Use PLUS or MINUS to adjust. Tap NEXT to skip to the next item.
CHANGE PRE-ALARMS	YES or NO	Tap YES or NO to enter gauges with no yellow bands displayed.
ENABLE PRE-ALARM MSGS	YES or NO	Tap YES or NO to enter gauges for pre-alarm setting for , HI EGT, HI TIT, HI CHT, HI OIL-T, HI MAP, LOW TANK, .
HI EGT = 1650	1250 ⇔ 1650 F	Use PLUS or MINUS to adjust. Tap NEXT to skip to the next item.
HI TIT =1650	1250 ⇔ 1650 F	Use PLUS or MINUS to adjust. Tap NEXT to skip to the next item.
HI CHT =450	260 ⇔ 460 F	Use PLUS or MINUS to adjust. Tap NEXT to skip to the next item.
HI OIL-T = 210	190 ⇔ 240 F	Use PLUS or MINUS to adjust. Tap NEXT to skip to the next item.

LOW OIL-T = 100	100 ⇔ 150 F	Use PLUS or MINUS to adjust. Tap NEXT to skip to the next item.
HI MAP = 30	30.0 ⇔ 38.0	Use PLUS or MINUS to adjust. Tap NEXT to skip to the next item.
LOW TANK = 5	1 ⇔ 50 gal.	In gallons or preset value. Use PLUS or MINUS to adjust. Tap NEXT to skip to the next item.
AVERAGE CRUISE RPM 2400	2043 ⇔ 2563 rpm	Hold NEXT and button 2 until you see ADJUST for two seconds. Tap PLUS or MINUS to adjust. Hold NEXT and button 2 to Save.
AMPS ADJUSTMENT + 0	-10 ⇔ 10	Use PLUS or MINUS to adjust. Tap NEXT to skip to the next item.
Engine HP 210	10 ⇔ 999 HP	Hold NEXT and button 2 until you see ADJUST for two seconds. Tap PLUS or MINUS to adjust. Hold NEXT and button 2 to Save.
Engine Constant 13.7	1 ⇔ 99	Hold NEXT and button 2 until you see ADJUST for two seconds. Tap PLUS or MINUS to adjust. Hold NEXT and button 2 to Save. Use 14.9 for non-turbo'd and turbonormalized and 13.7 for turbocharged engines.
LOP DFLT? N	YES or NO	Tap YES to make LOP your default setting. Tap NO to keep ROP your default setting.
SWAP DIALS? N	YES or NO	Tap YES to swap gauge positions or NO to keep it the way it is, unless it already says YES in which case you tap NO to swap gauge positions.

CO GUARDIAN? Y	YES or NO	Select YES or NO and hit NEXT to go to the next item. <i>Note: This feature requires a factory modification to the EDM-930 and will come with a connection diagram.</i>
FDR OUTPUT? Y	YES or NO	Allows recording output. Select YES or NO and hit NEXT to go to the next item.
END? Yes	NO or YES	YES exits the pilot program mode. NO re-enters the FACTORY programming mode. Holding buttons 1 and 2 will go into the Hobbs Time change function.
HOBBS TIMES	Hold buttons 1 and 2 to enter the change Hobbs times function.	Goes into the Hobbs change function.
AIRFRAME HOBBS:	DIGIT, PLUS or MINUS	Tap DIGIT to change the digit you want to change and PLUS or MINUS to go up or down numerically. Hold buttons 1 and 2 to Save and move onto Tach Time.
TACH TIME:	DIGIT, PLUS or MINUS	Hold buttons 1 and 2 to change TACH TIME. Tap DIGIT to change the digit you want to change and PLUS or MINUS to go up or down numerically. Hold buttons 1 and 2 to Save and move onto END?

Adjusting the HP Constant for Rich of Peak Operation

To fine tune the %HP readout, follow this procedure airborne between 5,000 and 8,000 feet MSL.

1. Enter the pilot program mode by simultaneously holding the STEP and LF buttons for five seconds.
2. Tap STEP repeatedly until you see **HP Constants**. Hold both NEXT and Button 2 until you see **ROP** and **LOP** appear in status bar. Tap **ROP**. Now **HP Constant 125** should appear. Hold both NEXT and Button 2 until you see **ADJUST** momentarily. Adjustment range for the HP Constant is 50 to 300.
3. Set the MP and RPM per your POH to 70 percent power. Let conditions stabilize.
4. Adjust the HP Constant value PLUS or MINUS so that the %HP reading on the display equals '**70 %HP**'. Note: this is the percent of maximum horsepower.
5. Hold both NEXT and Button 2 until you see **SET**.

Adjusting the MAP

This procedure allows you to adjust the MAP to the altimeter setting at a sea level airport. **NOTE: If airport is not at sea level, use the correction table on the next page to derive corrected sea level altimeter setting.**

1. Enter the pilot program mode by simultaneously holding the STEP and LF buttons for five seconds.
2. Tap NEXT repeatedly until you see **MAP ADJUSTMENT +0.0**. Then hold both the NEXT and Button 2 until you see **ADJUST** momentarily.

3. Adjust the value using the PLUS or MINUS until the value equals the altimeter setting (sea level airport). The adjustment range for the MAP is ± 3.0 inHg.
4. Hold both NEXT and Button 2 until you see **SET**.

Manifold Pressure Calibration

The manifold pressure must be calibrated to the ambient air pressure. Enter the current ambient barometric pressure. The engine must *not* be running. This setting is *not* the same as the altimeter setting that you receive from ATIS or Unicom. It will vary with field elevation. Use the chart below to calculate the MP FACTOR. Multiply this MP FACTOR by the altimeter setting that you receive from ATIS or Unicom. For example if the field elevation is 1700 ft and the altimeter setting is 30.1, the MP FACTOR is 0.9400 from the table. Multiply 30.1 x 0.9400 to get the ambient MP of 28.29.

Field Elev.	MP FACTOR	1200	1300	1400	1500	1600	1700	1800	1900	2000	2100	2200	2300	2400	2500	2600	2700	2800	2900	3000	3100	3200	3300	3400	3500	3600	3700	3800	3900	4000	4100	4200	4300	4400	4500	4600	4700	4800	4900	5000	5100	5200	5300	5400	5500	5600	5700	5800	5900	6000	6100	6200	6300	6400	6500	6600	6700
-500	1.0182	0.9574	0.9539	0.4	0.9469	0.9435	0.9400	0.9366	0.9332	0.9298	0.9264	0.9230	0.9196	0.9162	0.9129	0.9095	0.9062	0.9028	0.8995	0.8962	0.8929	0.8896	0.8863	0.8830	0.8798	0.8765	0.8733	0.8700	0.8668	0.8636	0.8604	0.8572	0.8540	0.8508	0.8477	0.8445	0.8414	0.8382	0.8351	0.8320	0.8289	0.8258	0.8227	0.8196	0.8165	0.8135	0.8104	0.8074	0.8043	0.8013	0.7983	0.7953	0.7923	0.7893	0.7863	0.7833	0.7804

Adjusting the HP Value

You must set the nominal horsepower of your engine. This value is used to calculate the percent horsepower display.

1. Enter the pilot program mode by simultaneously holding the STEP and LF buttons for five seconds.
2. Tap NEXT repeatedly until you see **Engine HP 200**. Then hold both the NEXT and Button 2 until you see **ADJUST** momentarily.
3. Adjust the value PLUS or MINUS to equal your engines HP.
4. Hold both NEXT and Button 2 until you see **SET**.

Fuel Flow K factor

The K factor is shown on the fuel flow transducer as a hand written four-digit number, which represents the number of pulses per tenth gallon of fuel flow. **Before installing the transducer, record its K factor here _____.** The EDM stores the K Factor in the form **29.12**, i.e. if the transducer K factor is 2912, you would enter 29.12 in the EDM's K factor field.

Fine Tuning the K factor

The K factor shown on the fuel flow transducer does not take into account your aircraft's particular installation. Fuel hose diameters and lengths, elbows, fittings and routing can cause the true K factor to be different from that shown on the fuel flow transducer. Fine tuning is accomplished over multiple flights of sufficient duration and repeatable conditions. Use the process below to calculate and correct the K Factor to achieve maximum performance. Note: This process adjusts the K factor only half of the correction. We recommend this because it minimizes 'chasing' a correction target back and forth.

Record data for three flights of about two to three hours each. Record the actual fuel used for each flight (total pumped to top the tanks) and the EDM **USD** value prior to shutting down after the flight.

<i>Flight</i>	EDM ' USD '	ACTUAL USED (Total pumped to top used tanks)
A		
B		
C		
Totals	❶	❷

2. Add up all flight amounts for each column and post Totals in locations ❶ and ❷.

3. Record the EDM's current K factor here ③ _____
and in the table below.

4. Calculate the Adjustment ratio:

$$\text{Adjustment ratio} = \frac{(\text{①} \quad \quad \quad / \text{②} \quad \quad \quad) - 1}{2}$$

5. New K Factor = ③ x (Adjustment ratio +1).

Record the values here:

<i>Date</i>	<i>①EDM fuel used</i>	<i>②actual fuel used</i>	<i>③Current K factor</i>	<i>New K factor</i>	<i>Pilot's initials</i>

Entering the K factor

This process is used to enter/modify the K factor value in the EDM.

1. Enter the pilot program mode by simultaneously holding the STEP and LF buttons for five seconds until you see **PROGRAM MODE**.
2. Tap NEXT repeatedly until you see **K-Factor 1 29.90** .
3. Hold DIGIT and Button 2 until the first digit flashes (shown here as bolder digit for illustration purposes): **29.90**
4. Tap DIGIT to move to the desired digit.
5. Adjust the digits value using PLUS or MINUS as desired.
6. Repeat items 4 and 5 for the remaining digits.
7. Hold both NEXT and Button 2 until you see **SET**.

If the K factor is increased, the indicated fuel flow will decrease, and vice-versa. *NOTE: When the K factor is changed during a trip, calculations of fuel used, fuel remaining and time to empty are not retroactively recalculated.*

Programming Trip Mode

Trip Mode keeps a running total of fuel used (USD) for all flights. If Trip Mode = No, fuel 'USD' is zeroed after updating the EDM's fuel computer via **Refuel** modes. *NOTE: to clear the fuel used display at any time, tap STEP until you see USD. Hold both DIM and ALL TEMP buttons until the display shows '.0 USD'.*

1. Enter the pilot program mode by simultaneously holding the STEP and LF buttons for five seconds.
2. Tap NEXT repeatedly until you see **TRIP Used? No** .
3. Tap YES to select the trip mode or NO to deselect mode.
4. Tap NEXT to accept your choice.

Setting the GPS Com Format

This process allows you to select what GPS communication format the EDM should use when sending fuel flow data to the GPS. See table below with the numeric GPS-C values and their corresponding formats.

1. Enter the pilot program mode by simultaneously holding the STEP and LF buttons for five seconds.
2. Tap NEXT repeatedly until you see **GPS FORMAT** .
3. Hold DIGIT and Button 2 until **ADJUST** appears
4. Select desired code value using PLUS or MINUS.
5. Hold both NEXT and Button 2 until you see **SET**.

<i>GPS-C</i>	<i>Type of GPS Format</i>
0	No fuel data output
1	Garmin (Shadin Miniflow format)
2	Allied Signal (format B) "To waypoint only"
4	Arnav/EI fuel flow data
4	Allied Signal (format C) *
5	(Not used)
6	Garmin 430/530 GNX-80/GX-60 "To waypoint only"
7	Garmin 430/530 GNX-80/GX-60 "To Destination only"
8	Bendix(B) - DEST

Section 10 - Custom Key Card

The EDM contains a Key Card which customizes it for your aircraft. **This card defines fixed primary instrument limits and ranges, EDM serial number and make, model and year of your aircraft. You cannot exchange it with any other EDM.** Typical parameters include: oil temp, oil pressure, fuel pressure, fuel quantity, cylinder head temp, turbine inlet temp, manifold pressure, and RPM. Do not remove the Key Card from the instrument. If your EDM should ever have to be replaced with a different unit, the factory will reprogram your Key Card to match the new serial number. Always confirm that your aircraft make and model are initially shown in the RAD upon power up.

Section 11 - Setting Fuel Calibration Points

WARNING:

- ! Never add or remove fuel from the aircraft when the master switch is turned on.**
- ! Fuel quantity gauge performance is affected by many factors, such as the integrity of the sensor performance, the accuracy of the calibration data you collected and entered and most importantly your validation that the EDM fuel quantity gauge is accurate and repeatable after installation and calibration. You should not use the fuel quantity gauge system for any flight related operations until this validation criteria has been met.**

The EDM interfaces to various fuel level sensor types to facilitate direct reading of the fuel level in the aircraft fuel tanks. The EDM has a multi-point fuel calibration table that you must enter. This table contains calibration values (stored in non-volatile memory) used to translate sensor readings into the displayed fuel quantity values. The calibration information is collected and recorded on paper for later entry into the EDM. NOTE: Fuel quantity gauges will not be functional until the fuel calibration information has been entered into the EDM. You will use the EDM instrument itself as the measuring device to collect calibration data. Refer to Installation Manual Report 908 for expanded information on fuel level system implementation.

The following describes the basic procedures necessary for collection and entry of data into the fuel level calibration table. Note: Any changes to fuel table data will be temporary until you execute the '**SAVE**' function (available after last cell of the last tank table is entered).

Before beginning the fuel table entry/edit process, you must have properly installed and tested for correct functionality of the fuel sensors.

Capturing the sender reading at each calibration

point: Getting Started... using the EDM as a meter.

1. With power off, hold in **Button 4 (Button 1 being far left)** and then turn on power. For each EDM monitored tank, create a **paper table** with the 5 points. The zero gallon point reading is always taken with unusable fuel in the tank. Example of a completed 3 point table for **LEFT** tank:

LEFT	
F	39.0 GAL 1907
$\frac{3}{4}$	29.3 GAL 1431
$\frac{1}{2}$	19.5 GAL 1145
$\frac{1}{4}$	9.8 GAL 971
E	0.0 GAL 685

2. This screen provides real-time readings of all active fuel level sensors. Verify readings look normal. Reading are arbitrary whole numbers
3. Now add fuel as needed to match the required volume for a particular point. Allow this to settle, then take a reading and record it on paper adjacent to that point.
4. Repeat this process until all points have been recorded for each tank.

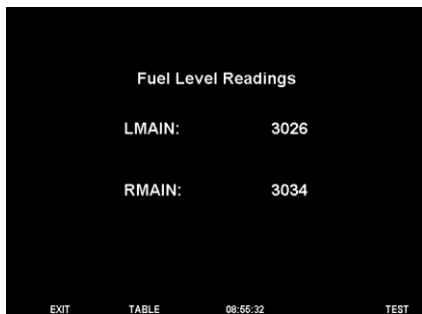

After you have collected your data

After you have collected your data

Entering / Editing Fuel Level Calibration Data

The Fuel Table Editor is a spreadsheet type format allowing you to easily see the volume and related calibration values side by side. You can easily navigate through the cells to enter values.

1. With power off, hold in **Button 3 (Button 1 being far left)** and then turn on power. Wait until you see '**Do you agree with the disclaimer?**'. Tap **YES** if you agree and wish to continue.

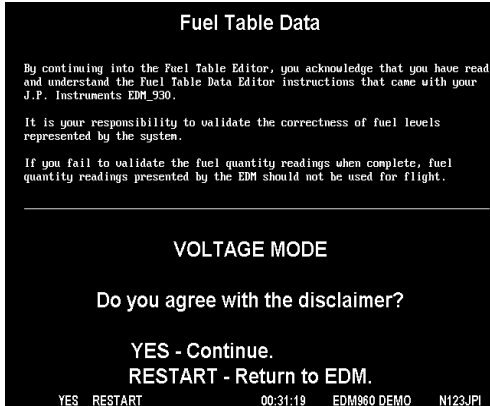

2. Tap **YES** when you see '**Do you have table data?**'.

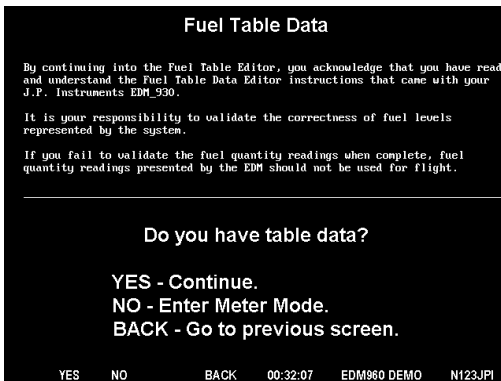

3. Tap **USER** when you see **'Do you want to restore user table?'**
 Note: tapping **FACTORY** causes the fuel table stored on the Key Card to over-write any previous user entries in the fuel table. Use **FACTORY** if you want to start from the original factory default.



4. Tap **TABLE**. You see **'Fuel Table Data'** (White at top of screen) with a table.

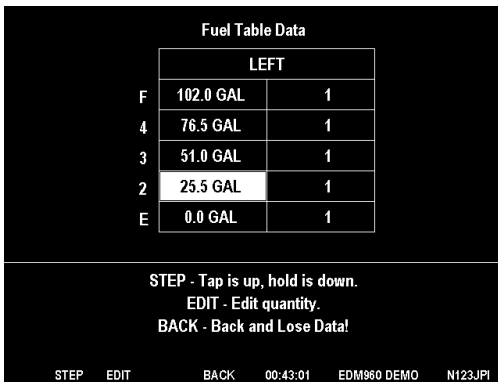

5. Tap/hold **STEP** to select the cell you want to edit. Tap **EDIT** to change the value. Tap **SAVE** to record it. Follow the on-screen menus to edit the value. Keep tapping **DIGIT** to move it across.
6. Repeat previous step until all tanks data have been entered.
7. You see ‘**Save fuel tank data?**’. Answer **SAVE** to store all final data values or **CANCEL** to return to table editing. Troubleshooting the EDM

Common Misapplications

<i>Problem</i>	<i>Situation</i>	<i>Correction</i>
Display freezes or may be incorrect	A power transient could cause the processors to malfunction	Recycle the power to the EDM
Lean Find finds a “peak” too soon	Failure to pre-lean before performing Lean Find or stopping while leaning	Continue to lean without stopping
	Leaning too slowly	Lean more rapidly
Peak not found during Lean Find	Lean Find not activated or stopping while leaning	Lean at the speed of approximately 10°F per second
Off-scale EGT columns, too high or low	Off-scale EGT column readings. EDM in the Normalize view (blue scales)	The higher sensitivity of the Normalize view can quickly go too high or low off-scale with only small changes in EGT.
First cylinder to peak is not the hottest	This is normal. The first to cylinder peak is not necessarily the hottest	
EGTs rise during single magneto check	This is normal, due to incomplete combustion persisting longer	
EGTs not uniform during low power operation	This is normal. Fuel and air distribution is not optimal at low power settings	

Diagnostic Testing on Startup and During Flight

When your EDM is first turned on it tests internal components, calibration and integrity of the probes. Most alarms are disabled until the engine has been started.

During flight, probes are constantly checked for inconsistent or intermittent signals. A faulty channel or probe encountered during start-up or during flight will be deleted from the sequence, producing a missing column or blank digital data.

Diagnostic Messages

The following displays indicate malfunctions in the system:

Startup and Operational Diagnostics

0.0 GPH	Zero's indicate Fuel flow is too low to register
--- GPH	Dashes indicate No fuel flow transducer signals
--- H.M	Dashes indicate No fuel flow transducer signals
OPEN PRB	Open probe. Wiring to probe is open circuit. Check wiring and crimps. Swap probes to troubleshoot.
BAD-PRB	Bad probe. Erratic reading. May be poor electrical connection. Swap probes to troubleshoot.
Red 'X' drawn through a single gauge	Measurement out of range.
Red 'X' drawn through all gauges for an engine	DAU failure or DAU communications error. Check power to DAU and wiring harness connections.
CAL ERR	Calibration error. Return unit to factory.
DSP XXX	Internal communication error. Return unit to factory.
COMM ERR	Internal communication error. Return unit to factory.
NO 15 MV	Calibration error. Return unit to factory.
NO 50MV	Calibration error. Return unit to factory.
NO 2.5V	Calibration error. Return unit to factory.
PWR DWN	Power down the instrument and power up again.
WARNCAL, WARNCFG	Transient warning messages. If they persistently occur, return the unit to JPI for repair.
HOBSEERR	The time of the most recent flight may not be reflected in the HOBBS meter.
HOBSEBAD	The HOBBS data has been corrupted. The HOBBS meter will be cleared.
HANGCFG, HANGCAL	Internal system errors. Return unit to factory.

GPS Interface Diagnostics

Measurements 'xxx REQ', 'xxx RES' and 'xxx MPG' are all missing from the scan.	No communications from GPS receiver to EDM. Possibly no connection or aircraft GPS is off.
NO - COM message and 'xxx REQ', 'xxx RES' and 'xxx MPG' are all missing from the scan.	Communications are received by EDM and the Auto-Protocol setup is in process. Verify correct output format setup in GPS receiver; check GPS connections.
NO - SIG message and 'xxx REQ', 'xxx RES' and 'xxx MPG' are all missing from the scan.	GPS receiver has insufficient signal for valid data.
NO - WPT message and 'xxx REQ', 'xxx RES' are all missing from the scan.	No waypoints are programmed into the aircraft GPS receiver.
Message '- - - REQ' or '- - - RES' appears.	Your ground track is too many degrees (typically more than $\pm 70^\circ$) off from your course to the next GPS waypoint.

Section 12 - Appendices

TSO-only differences from Primary Instruments

TSO-only models have the following differences from the Primary models.

- If multiple alarms occur simultaneously, the higher priority alarm will temporarily “mask” the lower priority alarm(s). When an alarm occurs, tap the Clear button to clear the alarm indication so that you will be notified of any other alarm that might have occurred. The alarm priorities are as follows:

Highest priority	CHT	High CHT
	O-T	High OIL temperature
	O-P	Low oil pressure
	F-P	Low fuel pressure
	TIT	High TIT
	TK-LOW	Fuel tank low
	MIN	Low fuel endurance remaining
	REM	Low fuel quantity remaining
	F-P	High fuel pressure
	EGT	High EGT
	MAP	Over boost Manifold pressure
	DIF	Excessive EGT span
	CLD	Excessive CHT cooling rate
	RPM	RPM over redline
	O-T	Low oil temperature
	BUS	High battery voltage
	BUS	Low battery voltage
	O-P	High oil pressure
	AMP	Amps discharge
Lowest priority	BAL	Fuel level out of balance

- Aircraft make and model will not be shown in the RAD upon power up and will not be continuously shown on the bottom of the display window.
- The user can change factory set ranges and alarm limits.
- The Key Card is *not* programmed with the make, model and year of your aircraft.

- RAD alarm displays will be cleared and disabled along with the alarms displayed in the Scanner section.
- JPI Hastaloy-X probes may read as much as 100°F higher than the factory installed TIT probe. However, note that the engine was certified with the factory-installed TIT probe and gauge, and this gauge reading is the limiting factor when adjusting your engine.
- The user can assign the nine graphs in the bar graphs section to the desired measurements .
- Most measurements can be excluded from the *Automatic mode*.

Shock Cooling

Cooling the cylinders too fast can result in cracking and eventual failure. Lycoming Service Instruction 1094D (March 25, 1994) on ***Fuel Mixture Leaning Procedures states:***

“At all times, caution must be taken not to shock cool the cylinders. The maximum recommended temperature change should not exceed 50°F per minute.”

JPI checks shock cooling on all cylinders displaying the highest reading cylinder.

Rear Apron Connector Locations

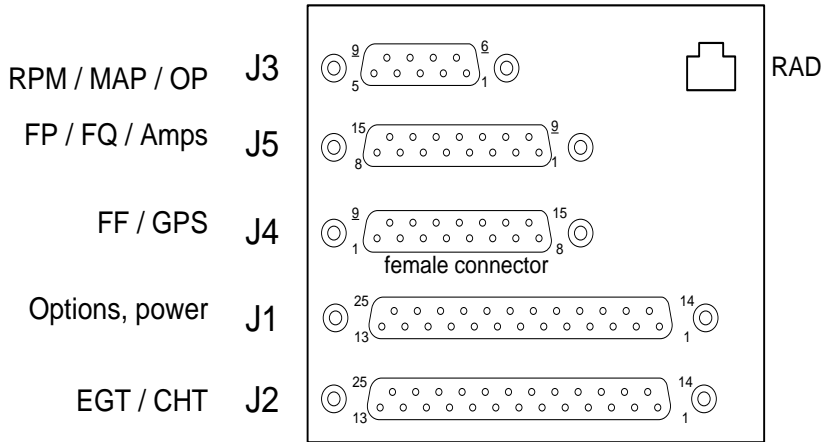

Connector pin assignments

P1 (for 4 / 6 cyl engine)		
Pin #		Function
yel 1	red 2	OIL T
yel 3	red 4	IAT
yel 5	red 6	CARB T
yel 14	red 15	OAT
yel 16	red 17	TIT 1
yel 18	red 19	TIT 2
	gry 12	rem V/T alarm
	red 13	+ Power
	wht 11	data in
	wht 24	data out
	blk 25	gnd to engine

P2 (EGT , CHT)		
Pin #		Function
yel 1	red 2	CHT 1
yel 3	red 4	CHT 2
yel 5	red 6	CHT 3
yel 7	red 8	CHT 4
yel 9	red 10	CHT 5
yel 11	red 12	CHT 6
yel 14	red 15	EGT 1
yel 16	red 17	EGT 2
yel 18	red 19	EGT 3
yel 20	red 21	EGT 4
yel 22	red 23	EGT 5
yel 24	red 25	EGT 6

P3 (MAP, RPM, OIL-P)	
Pin #	Function
grn 1	RPM sig (1)
blk 2	RPM gnd (2)
red 3	RPM pwr (3)
red 4	MAP pwr (3)
blk 5	MAP gnd (1)
wht 6	OIL-P sig (no pol)
blk 7	OIL-P sig (no pol)
wht 8	MAP sig+ (2)
grn 9	MAP sig- (4)

P4 (Fuel Flow, GPS)	
Pin #	Function
wht 1	out to GPS
gry 2	in from GPS
3	(nc)
wht 4	FF sig
red 5	FF power
blk 6	FF gnd
10	R tank low switch input
11	remote FF alarm
12	FF2 sig
13	L tank low switch input

P5 (FP, FQTY, AMPS)	
Pin #	Function
1	FQ 1 volt sig
2	FQ 1 volt sig
3	FQ gnd
4	FP sig+ (grn)
5	FP sig- (wht)
6	FP pwr (red)
7	FP gnd (blk)
9	FQ 1 freq sig
10	FQ 2 freq sig
11	FQ 1 pwr
12	FQ 2 pwr
13	Secondary +Power

P1 (for 7 / 8 / 9 cyl engine)		
Pin #		Function
yel 1	red 2	OIL T
yel 3	red 4	CARB T
yel 5	red 6	CHT 7
yel 7	red 8	CHT 8
yel 9	red 10	CHT 9
yel 14	red 15	OAT
yel 16	red 17	TIT 1
yel 18	red 19	EGT 7
yel 20	red 21	EGT 8
yel 22	red 23	EGT 9
	gry 12	rem V/T alarm
	red 13	+ Power
	wht 11	data in
	wht 24	data out
	blk 25	gnd to engine

Navigation Data Formats

Output of GPS; input to EDM. The EDM automatically configures itself for one of three industry standard data formats:

<i>Format</i>	<i>Baud</i>	
NMEA-183 (Marine Nav Data Format)	4,800	This is the format for most handheld GPS receivers. Loran must have sentences RMA & RMB. GPS must have sentences RMB & RMC.
Aviation Data Format	9,600	"Output sentence type 1" Required sentences are: A, B, C, D, E, I and L first character identifier byte. Sentence terminator may be either <CR><LF> or <CR> alone.
Northstar (Northstar binary)	1,200	M1 setup select "NO EXTENDED", "NAV ONLY"

Navigation Data Ports for GPS Comm

(These ports are independent of the EDM serial data output port.)

Navigation Data (output from GPS; input to EDM)

Compatible with RS-232, TTL, RS-423, RS-422 SDA.

Serial format: 8 data, 1 start, no parity. Baud 1200, 4800, or 9600, depending on the GPS data output format. The EDM automatically detects the GPS data output format and is independent of the GPS-C setting.

Fuel Data (input to GPS; output from EDM)

RS-232 Serial format: 8 data, 1 start, no parity. Baud 9600. Output format is determined by the GPS-C setting, but may be over-ridden by the GPS navigation format: If the EDM senses Northstar or NMEA-183 navigation data input, there will be no fuel data output.

Interface connections to selected GPS models

	EDM P4 - Pin 1 to:	EDM P4 - Pin 2 to:
Amav 5000	Pin 4	Pin 5
Garmin 195	(nc)	Pin 4
Garmin 430 / 430	Pin 57	Pin 56
Northstar M3P	(nc)	Pin 6 (leave pin 11 open)
UPS GX50 / 60	Pin 4	Pin 5

Contents

<u>1. Overview</u>	73
<u>2. DISCLAIMER</u>	73
<u>3. Starting EDM930/960 Configuration Editor</u>	74
<u>4. Changing Gauge Layout</u>	75
<u>5. Removing Fuel Level Gauges from display</u>	76
<u>6. Replacing Gauges</u>	78
<u>7. Changing Gauge Markings</u>	79
<u>8. Gauge Details Screen</u>	80
<u>9. Gauge Range and Alarm Limits</u>	81
<u>10. Color Bands</u>	82
<u>11. Options</u>	82
<u>12. Modifying Aircraft Information</u>	83
<u>13. Changing Tail Number</u>	83
<u>14. Change Number of Engine Cylinders</u>	84
<u>15. Changing fuel units</u>	85
<u>16. Changing Main Tank Size</u>	85
<u>17. Changing Channels Monitored</u>	86
<u>18. Changing Alarm Values</u>	87
<u>19. EDM Alarms Screen</u>	87
<u>20. Restoring EDM to a Previous Configuration</u>	88
<u>21. Restoring EDM to Factory Configuration</u>	89

1. Overview

This program assists you in configuring the EDM-930 SINGLE and EDM-960 TWIN unit. In this guide they will all be called EDM. The EDM has numerous parameters that control the operation of the unit. All non-primary user parameters can be modified either by (1) using the four-button interface on the front panel of the EDM or (2) by using EDM Configuration Editor—described here—that provides a windows based utility that facilitates modifying these various parameters in a user-friendly way. Note: appearances may vary due to different revisions and instrument configurations.

EDM's approved as primary instruments have preset alarm limits and do not allow changing of these primary alarm limits and cautionary ranges for the following measurements: oil temperature, oil pressure, fuel pressure (Optional in some aircraft), fuel quantity, cylinder head temperature, turbine inlet temperature, manifold pressure, and RPM. Other non-primary parameters may be changed by the user.

2. DISCLAIMER

Proper configuration of your J.P. Instruments EDM is very important to the safe operation of your aircraft. All primary instrument settings must conform to the manufacturer's limitations for your aircraft.

It is your responsibility to ensure that all limitations and markings are correct before operating your aircraft.

By continuing to run the EDM Configuration Editor, you acknowledge:

- You have read the Pilot's Guide for this device
- You have read the EDM Configuration Guide
- You will not use this program for any purpose other than configuration of your J.P. Instruments EDM system.
- Your agreement with this information.

3. Starting EDM930/960 Configuration Editor

All EDM930 and EDM960 units manufactured or updated after Sep 14, 2012 have the EDM Configuration Editor built into a separate utility memory area of the EDM.

To start the EDM Configuration Editor, hold the left two EDM buttons (STEP & LF) while powering up the EDM. This will start the EDM in a special **AppLoader** mode. Once the EDM Configuration Editor program is found, a button will be labeled **CFG EDITOR**. Press the button to run the EDM Configuration Editor program.

When EDM Configuration Editor starts, it will show a startup screen titled **EDM960 Configuration Editor** or **EDM930 Configuration Editor** that lists the version information for the Editor.

USB Configuration Capturing- Captures all your settings except fuel tables and keeps them for later use. You may insert a clean USB thumb drive any time during use of the program Config Editor. **STEP** through all the levels offered until **End Config Edits** and insert the USB thumb drive. Hit **SAVE** and the configuration will be downloaded and time stamped to the thumb drive. When making changes to anything while using Config Editor install the thumb drive before saving and it will save the previous configuration and time stamp.



EDM960 Configuration Editor Version 1.0



Press any key to begin

Note: Images are for example only and may not be representative of your actual display.



4. Changing Gauge Layout

Positions of non-primary linear strip gauges can be exchanged with other non-primary gauges on the right half of the display. When you see the **EDIT GAUGE LAYOUT?** prompt, tap the **YES** key to allow selection of gauges to be repositioned on the EDM screen.

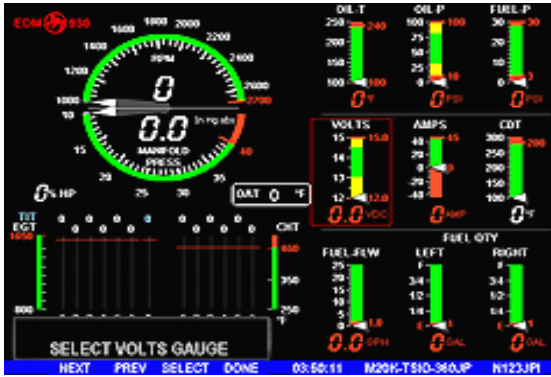

Tap the **NEXT** key to select the strip gauge to be moved. If you go past the desired strip gauge, Tap the **PREV** key to go back to the previous gauge.

Tap the **SELECT** key to start repositioning of the gauge on the EDM.

After a gauge is selected, tap the **NEXT** key to select the new position for gauge to be moved. When the correct location has been selected, tap the **MOVE** key. When all desired gauge location changes have been made, tap the **DONE** key to exit this screen. If you get an extended “Loading...” comment on the display just hit STEP or NEXT.

Notes: If the EDM is configured as a PRIMARY instrument, PRIMARY gauges cannot be moved and will be skipped.

The EDM screen must contain at least 2 non-primary gauges in order to allow repositioning of gauges.

Editing of Gauge Layout requires EDM software version 1.20.464 or later.

5. Removing Fuel Level Gauges from display

If you prefer to use the ship’s fuel level gauges, you can choose to remove the fuel level gauges from the EDM display. When you see the **EDIT GAUGE LAYOUT?** prompt, tap the **YES** key to allow selection of the fuel level gauges to be removed from the EDM screen.

Tap the **NEXT** key to select the fuel level strip gauge to be removed.

Tap the **REMOVE** key to remove the fuel level gauge from the EDM. Both fuel level gauges will be removed.

If you want to re-enable fuel level gauges on the EDM, tap **NEXT** key until the fuel level gauge location is selected. Tap the **ADD** key to restore the fuel level gauges to the EDM display. Tap the **DONE** key to exit this screen.



6. Replacing Gauges

You can select the information to be displayed on any non-primary linear strip gauge. For example, you may want to replace OAT with CDT or CARB temperature gauges. . When you see the **EDIT GAUGES?** prompt, tap the **YES** key to allow selection of gauges to be replaced with another gauge on the EDM screen.

Tap the **NEXT** key to select the strip gauge to be replaced or Tap the **PREV** key to select the previous gauge.

Tap the **MODIFY** key to start editing of the selected gauge.



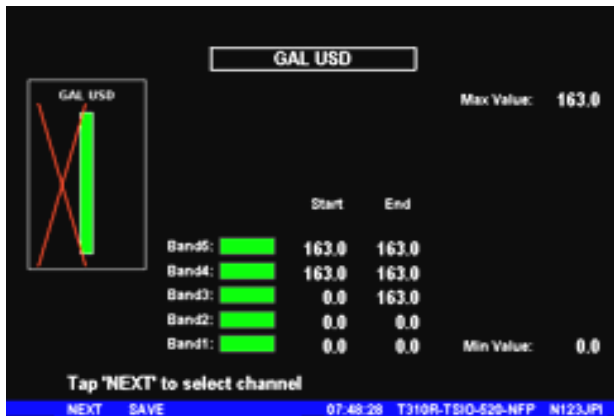

Tap the **Next** key until the gauge name is highlighted (box around gauge name). Tap the **MODIFY** key to start selection of a new input channel to be displayed on this gauge. Tap the **YES** key if you want to change the gauge name. Tap the **NEXT** key until the desired gauge name is selected. When you have selected the desired gauge, tap the **SAVE** key to replace the original gauge with the new gauge. Tap the **YES** key if you want to make the change. After the new gauge is displayed, you will want to tap the **MODIFY** key to set the gauge markings and limits for your aircraft. See the “Changing Gauge Markings” section below.

Note: If the EDM is configured as a PRIMARY instrument, PRIMARY gauges cannot be removed or replaced.

Replacing gauges requires EDM application version 1.20.489 or later.

7. Changing Gauge Markings

When you see the **EDIT GAUGES?** prompt, tap the **YES** key to allow selection of gauges to be modified on the EDM screen.

Tap the **NEXT** key to select the next gauge to be modified. Hold the **NEXT** key to select the previous gauge.

Tap the **MODIFY** key to start modification of the gauge on the EDM. Use the **NEXT** key to navigate through each position on the gauge to change color or limit markings.

When all desired changes have been made, tap the SAVE key. Tap YES to save the gauge changes.

When all desired changes have been made, tap the **DONE** key to exit this screen.

Note: If the EDM is configured as a PRIMARY instrument, PRIMARY gauges cannot be modified and will be skipped.

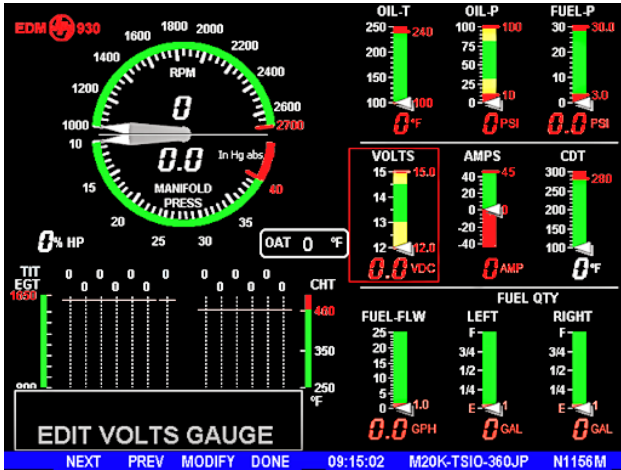

8. Gauge Details Screen

When the **MODIFY** key is tapped, the Gauge Details Screen will be displayed with an image of the selected gauge and all available values to be modified for the gauge.

The gauge details screen lets you select the minimum and maximum scale, the alarm limits, and the color band positions for normal, warning and alarm ranges. VOLTS will be used as an example how to configure gauge markings.

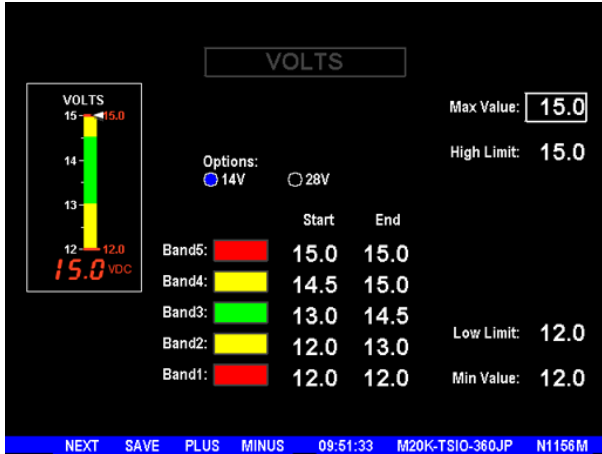

9. Gauge Range and Alarm Limits

To change **the gauge range**, use the **NEXT** key to select the **Max Value** or **Min Value**, and use the **PLUS** and **MINUS** keys to **adjust the value**.

When a gauge contains a **RED** band in the **Band5** position, a **High Limit** is associated with the gauge. When a gauge has a **High Limit**, the EDM will display an **Alarm** message when the gauge value is greater than or equal to the **High Limit** value. Changing **Band5** color from **RED** to any other color disables the **High Limit** and the EDM's **High Alarm** for the gauge.

When a gauge contains a **RED** band in the **Band1** position, a **Low Limit** is associated with the gauge. When a gauge has a **Low Limit**, the EDM will display an **Alarm** message when the gauge value is less than or equal to the **Low Limit** value. Changing **Band1** color from **RED** to any other color disables the **Low Limit** and the EDM's **Low Alarm** for the gauge.

10. Color Bands

The color band configuration system enforces the following rules:

- All gauges are configured with five color bands containing from one to five unique colors.
- Color bands are “connected” – the end of one band is connected to (the same value as) the start of the next band, etc.
- If the color band start and end values are equal, the color band will be invisible.
- Two consecutive bands of the same color appear as a single band of that color.
- Changing a color band’s color or start or end value will update the gauge image on this screen.

11. Options

The VOLTS, AMPS and OAT gauge screens have Options selections that allow you to quickly configure the default values associated with the select option. For example, selecting 28V in the VOLTS screen above would load the default values for a 28 volt electrical system. Note: changing the Options value will change multiple band values.

Saving the Data

When you have completed the new configuration for the gauge, tap the SAVE key to save the configuration to the EDM.

Note: This change is immediate when saved.

12. Modifying Aircraft Information

After agreeing to the EDM Configuration Editor Usage Agreement, you will have the opportunity to view a quick slide show describing the basic operation of the EDM Configuration Editor.

If the EDM is a primary instrument configured for a particular aircraft, only values associated with non-primary gauges can be modified. In addition, the aircraft type, aircraft tail number, and engine information will be read-only.

13. Changing Tail Number

When prompted for TAIL NO: you will notice that the tail number information is displayed in gray text. Hold the NEXT and PREV keys to start editing of the aircraft tail number information. The

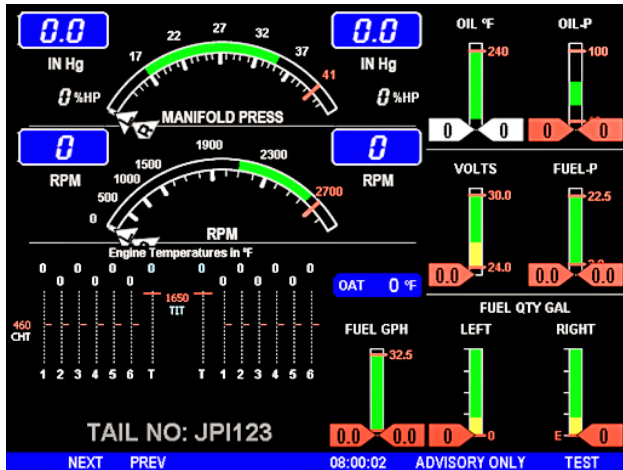

first character of the tail number will start to flash, indicating that the character will be changed when you tap or hold the UP or DOWN keys

Tip: The EDM uses gray text whenever the value to be

modified is “protected.” Protected values are those when require an extra step to prevent accidentally modifying the value. Holding the left two keys (NEXT and PREV) unlocks the value to be edited. When you have made the desired changes to the value, hold the two left keys again to store the new value.

If the EDM is configured as a TSO or Advisory Only unit, you will be allowed to change nearly all EDM configurable parameters, including the aircraft ID and engine information.

14. Change Number of Engine Cylinders

The CYLS= prompt allows you to change the number of cylinders monitored and displayed by the EDM. Hold the two left keys to start changing the number of cylinders. Tap the PLUS or MINUS keys to increase or decrease the number of cylinders. Acceptable values are 4, 6, 7, 8 or 9. Hold the two left keys to save the modified value.

After changing the CYLS= value, you may also need to change the R-FACTOR value. The R-FACTOR is used to specify the number of pulses per revolution output by your RPM sensor. Available values are 4 – 12.

Changing Engine Temperature Units

The ENG °F / °C prompt allows you to change engine temperature units displayed by the EDM. Hold the two left keys to start changing the number of cylinders. Tap the F or C keys to change to Fahrenheit or Celsius. Hold the two left keys to save the modified value. Note: If the EDM is configured as a PRIMARY unit, you will not be allowed to modify the Engine Temperature Units except OAT.

15. Changing fuel units

Hold the left two keys to allow changing the FUEL UNITS. Available values are GAL, LBS, LTR, KGS. Hold the left two keys to save changes to FUEL UNITS. Note: Changing FUEL UNITS is only available for TSO and ADVISORY ONLY EDM units.

Note: For PRIMARY units the following changes to the main and aux tank size applies to the fuel totalizer only. For main tank capacities see fuel level section.

16. Changing Main Tank Size

Hold the left two keys to allow changing the MAIN SIZE. Available values are 0.0 to 999.9 gallons, or 0 to 9999 liters, pounds, or kilograms. Hold the left two keys to save changes to MAIN SIZE.

Changing Aux Tank Size

Hold the left two keys to allow changing the AUX SIZE. Available values are 0.0 to 999.9 gallons, or 0 to 9999 liters, pounds, or kilograms. Hold the left two keys to save changes to AUX SIZE.

17. Changing Channels Monitored

When you see the EDIT CHANNELS? prompt, tap the YES key to display the EDM Probe & Sensor Channels screen.

Tap the STEP key to select the next channel to be enabled or disabled. Hold the STEP key to select the previous channel.

Tap the ENABLE key to mark an “X” to enable the selected channel on the EDM or DISABLE to remove an “X” to disable the selected channel on the EDM.

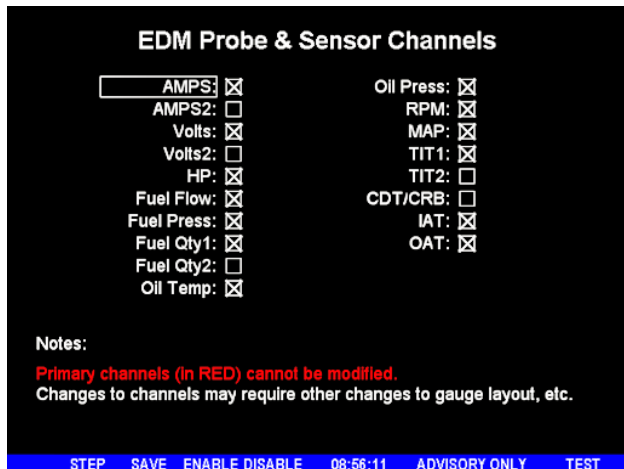

When all desired changes have been made, tap the SAVE key to exit this screen. If changes have been made on this screen, you will be asked Save Channel Changes? Tap the appropriate key (YES or NO).

Note: If the EDM is configured as a PRIMARY instrument, data channels associated with PRIMARY gauges will be displayed in RED and cannot be modified.

18. Changing Alarm Values

When you see the EDIT ALARMS? prompt, tap the YES key to allow selection of alarm values to be modified.

	Alarm Value	
	High	Low
Legend:	---	---
Not all alarms can be modified.		
Values in RED are PRIMARY values.		
Values in YELLOW are configured using the GAUGE EDIT screen.		
Alarms of --- do not exist.		
AMPS:	---	---
Volts:	15.0	12.0
Endurance:	---	45
Fuel Rem:	---	10.0
Fuel Press:	30.0	3.0
Fuel Flow:	---	0
Oil Temp:	240	100
Oil Press:	100	10
CHT:	460	---
Shock Cool (CLD):	60	---
EGT Span (DIF):	500	---
RPM:	2700	---
MAP:	40.0	---
EGT/TIT:	1650	---

19. EDM Alarms Screen

The EDM Alarms window lets you change some alarm limits. When these values are met or exceeded, a flashing message will be displayed in the EDM's message area.

- You may change any value shown in WHITE.
- Values shown in YELLOW are configured on the gauge displaying the value.
- Values shown in RED are PRIMARY LIMITS and are prohibited from modification.
- Values shown in GRAY do not have an associated alarm.

When you are done changing the alarm limitations press the SAVE key. Alarms associated with gauges displayed on the previous gauge configuration screen, cannot be modified here. Tap PREV to return to the GAUGE EDIT screen to modify values displayed in YELLOW. When used as a primary instrument, government regulations do not allow modification of settings in red.

When you have finished changing the alarms for your aircraft, tap SAVE to move to the next screen.

20. Restoring EDM to a Previous Configuration

When you start the EDM Configuration Editor, you will see a RESTORE FROM USB DRIVE message after the program tutorial screens. You may use this prompt to restore the EDM to a configuration saved during the editing process earlier.

- When you see RESTORE FROM USB DRIVE, install the USB FLASH drive and tap the YES key.
- You will be asked to select the date and time of the saved configuration to be loaded. The EDM will sort the ten most recent backups with the most recent backup file first.
- When you see the point in time that you would like to return to, hold the left two EDM keys until the word SUCCESS EDM RESTORED appears in the message area.
- Follow the prompt to REMOVE THE USB. At this point the EDM will reboot.

21. Restoring EDM to Factory Configuration

Suppose the changes you made are not what you expected. You can restore your EDM to the FACTORY settings for your aircraft by following this procedure:

- Start the EDM Configuration Editor as described on page 2 above.
- Tap NEXT until you see End Config Edits (with YES / NO keys).
- Press and hold both the YES and NO keys until FACTORY RST? is displayed.
- Tap YES key.
- Tap YES key a second time to confirm the reset operation. Warning: All user settings, including K-Factors, and other preferences will be erased. In order to save all pre-set values except fuel tables see USB Configuration Capturing on page 3.
- After the reset operation completes, you will be returned to End Config Edits prompt. Tap the YES key.

Technical Support

JPI offers both e-mail and telephone technical support. Have your model and serial number ready when you call. Call **JPI** for a return authorization number (RMA Number) before returning any equipment.

J.P.INSTRUMENTS Inc.
3185-B Airway Ave.
Costa Mesa, CA 92626
Call: (800) 345-4574
Web: www.jp instruments.com

Limited Warranty

J.P. Instruments Inc. (JPI) warrants all parts in your new EDM to be free from defects in material and workmanship under normal use. Our obligation under this warranty is limited to overhaul or exchange of any defective part of this unit if the part is returned, shipping prepaid, within three years for electronics and one year for probes from the date of original purchase. Installation labor is the responsibility of the aircraft owner. Homebuilt aircraft warranty starts when the aircraft is certified for flight. Replacement parts carry a warranty for the balance of the warranty period.

Under this warranty, JPI is not responsible for any service charges, including removal, installation, nor any other consequential damages. JPI incurs no obligation under this warranty unless a Warranty Registration Certificate describing the warranted product has been completed and mailed to JPI with all information requested.

This warranty is void on any product which has been subject to misuse, accident, damage caused by negligence, damage in transit, handling or modification which, in the opinion of JPI, has been altered or repaired in any way that effects the reliability or detracts from the performance of the product, or any product whereon the serial number has been altered, defaced, effaced or destroyed.

This warranty is in lieu of all other warranties expressed or implied and other obligations of liability on JPI's part, and it neither assumes nor authorizes any other person to assume for JPI any other liability in connection with the sale of JPI products.

To initiate this warranty, the aircraft owner must submit a completed Data Logging Worksheet to JPI. Upon receiving a completed worksheet, JPI will initiate the warranty from the date of original purchase. Any replacement parts carry a warranty that extends for the balance of the period of the original warranty. For homebuilt aircraft the warranty starts when the aircraft is certificated for flight and noted on the warranty card.

Index

* Pre-leaning procedure:, 23

A

Accumulate, 48
total, 34
Alarm
priority, 35
Alarm limits, 5, 35
display, 13
Alarms, 35
Alerts, 35
Allied Signal, 49
Automatic mode, 18
Aviation data format, 63

B

BAL, 59
Bar graph, 5, 16
column resolution, 14
Baud rate, 63
Blinking display, 22, 23, 28
Button
DIM, 13
LF, 13
RoP/LoP, 13
Buttons
front panel, 4

C

Calibration
fuel level, 50
horsepower, 45, 46
internal self test, 56
K factor, 46
MAP, 45
OAT, 40
Carburetor
ice, 10
temperature, 19
Celsius
display indicator, 15
OAT, 40

For Your Safe Flight

Change
button, 13

CHT
too high or too low, 11
Climb, 8
Compression, 11
low, 10
Compressor discharge temperature,
CDT, 19
Connector
pin assignments, 61
Cowling, obstruction, 11
Cruise, 8

D

GPS formats, 63
ports, GPS, 63
Delete measurements, 18
Descent, 8
Detonation, 10, 11
Diagnostic
fuel flow messages, 57
GPS interface messages, 58
self test, 56
DIF, 19
DIM, 13
Display, 14
digital, 15
flashing, 22, 23, 28
Scanner, 14
Downloading, 36 Data

E

EDM Config Editor 38, 64
EGT
loss, 10
resolution, display, 40
select switch, 34
too high, 10, 56

Page | 91

too low, 10, 56
Eliminate measurements, 18
Engine
 diagnosis chart, 10
 limits, normal, 9
 run-up, 7

error messages, 56
Exclude measurements, 18
Exhaust leak, 11

F

Fahrenheit
 display indicator, 15
 OAT, 40
Failure to pre-lean, 56
Features, 5
FF, select switch, 34
First cylinder to peak, 24
First time setup, 38
Flashing display, 22, 23, 28
Flat EGT response, 10, 11
Fuel
 accumulate, 34
 injectors, 11
 injectors, clogged, 8, 10
 Octane, 11
 pump, 11
 remaining, 19
 required, 19
 reserve, 19
 start up, 3, 30
 used, 19
Fuel flow, 29
 connector, 61
 diagnostics messages, 57
Fuel level
 calibration, 50
Full throttle, 8

G

GAMI, 20, 28
Gasket, manifold, 11
Getting started, 1
GPS
 data formats, 63
 data ports, 63
 interface diagnostics, 58

H

H.S, 19
Hastaloy, 28, 60
History
 display, 72
Hobbs, 13
 display, 17
Holding a button, 4, 12
Horsepower
 calibration, 46
 constant setting, 45

I

Ice, carburetor or induction, 10
Ignition, 11
 timing, 10
Include measurements, 18
Indexing
 scan rate, 40
Induction, 10
 air temperature, IAT, 19
Informing the EDM-930
 startup fuel, 30

Intake valve, 10
Interpreting
 data, 7
 display, 10

K

K factor
 calibration, 48
Key card, 1, 49
K-factor
 calibration, 46

L

Leak
 manifold, 11
Leanest cylinder, 22, 23
LeanFind
 button, 13
 procedure, 6, 20
Leaning
 by TIT, 28
 too quickly, 56
LF. See LeanFind
Long Term Memory
 operation, 36

M

Manual mode, 19
MAP
 calibration, 41, 45
 display, 5, 14
Miles per gallon, 19
Misapplications, 56
Missing
 column, 10
Mixture, 24
MPG, MPK, MPL, MPP, 19

N

Nautical miles per gallon, 19
Navigation data formats, 63
NMEA-183, 63
NO COM, 58
NO SIG, 58
NO WPT, 58
Normal engine limits, 9
Normalize view, 15
Northstar binary format, 63
NRM, 15

O

OAT
 calibration, 40
 F or C, 40
Octane, 11
Off-scale EGT bars, 56
OPEN PRB, 57
Operation, 12, 18
 fuel flow monitor, 29

P

Peak EGT, 24
PEAK EGT, 22, 23, 26
Pin assignments
 connectors, 61
Pre-leaning, 23
Primary, 1
 preset alarm limits, 1, 49
Priority
 alarm, 35
Product support, 64

R

RAD, 1, 5, 17
Range, normal temperature, 9
Rate
 baud, 63

- fuel flow, 29
- indexing, 40
- shock cooling, 8
- Recording. *See* Long Term Memory
- Red line, 9
- REM, 19
- Remote Auxiliary Display. *See* RAD
- Remove measurements, 18
- REQ, 19
- RES, 19
- Resolution, EGT display, 40
- Rich of Peak, 20
- RoP/LoP
 - button, 13
- Rough engine, 10
- RPM
 - display, 5, 14
- RS-232, 63
- Run-up, 7

S

- Scanner
 - displays, 14
- Scanner®, 6
- Select switch, 34
- Setup, 38
- Shadin Miniflow, 49
- Shock cooling, 8, 9, 19, 60
- Spark plug
 - fouling, 7, 10
- Standard view, 15
- Startup
 - diagnostics, 56
 - fuel, 3, 30
- Stuck valve, 10
- Switch, select, 34

T

- Tachometer. *See* RPM

- Take-off, 8
- Tapping a button, 4, 12
- Technical support, 64
- Test, self, 56
- Time to empty, 19
- Timing, ignition, 10
- TIT, 28
- Toggle, N, P, 15
- Total
 - fuel used, 19, 48
- Total fuel, 34
- Transducer, fuel flow, 29
- Trip total, 48
- Troubleshooting
 - engine, 10
 - GPS, 58
 - instrument, 56
- Troubleshooting
 - fuel flow, 57
- TSO-only models, 59
- Turbocharged Engines, 28

U

- Uniform, CHT, EGT not, 10
- USD, 19

V

- Valve
 - lifter, 10
 - stuck, 10
- Vapor, 11
- View
 - change diagram, 13
 - normalize, Standard, 15

W

- Warranty, 64

QUICK REFERENCE

Automatic Scan

1. Tap LF.
2. Tap STEP.

Exclude Measurement in Automatic Scan (toggle)

1. Tap STEP to index to the measurement to exclude.
2. Tap both STEP and LF to toggle exclude/include status.
3. Decimal point before measurement name means it is excluded from scan.

Change Scan Indexing Rate

1. Hold STEP and LF until the display shows PROGRAM, followed by Refuel ?.
2. Tap NEXT, see Auto Scan Rate x .
3. Tap PLUS or MINUS to change the seconds per scan: 0 to 9.
Note: 0 disables auto scanning.
4. Tap NEXT until you see End?Y, then EXIT to accept and exit.

Reset USD (Fuel Used)

1. Tap STEP until x USD shown.
2. Hold both DIM and TEMP FUEL until .0 USD is shown.

Display Hobbs

1. Hold the LF and DIM buttons simultaneously.

Download Data in Memory

1. Insert USB Flash Drive into front USB port on EDM.
2. *DOWNLOAD: NEW* (latest flight) or tap CHANGE to see *DOWNLOAD: ALL* (all stored flights).
3. Tap STEP and wait until download progress bar completes and normal display returns.
4. Remove USB Flash Drive.

Trip Mode (Accumulate Fuel Used)

1. Hold both STEP and LF until the display shows PROGRAM, followed by Refuel ?.
2. Tap NEXT until you see Trip Used? No .
3. To accumulate all fuel used, tap Yes and see TRIP? Y.
4. Tap left button until you see End ?Y and tap Yes to exit.

All following features are found in the **FACTORY** menu of your EDM. To get to the **FACTORY** menu follow this procedure:

- 1) Turn the unit on and wait for it to cycle to normal operation.
- 2) Hold buttons 1 and 2 until you see "PROGRAM" at the bottom of the display.
- 3) Tap the **NO** button when prompted to refuel.
- 4) Keep tapping the **NEXT** button until you see "END ?"
- 5) At this point tap the **FACTORY** button (button 4). This will get you into the **FACTORY** menu.

Changing Fuel Units

Once in the **FACTORY** menu, tap the **NEXT** button until you see **FUEL UNITS: GAL**. Hold buttons 1 and 2 until you see **ADJUST GAL** and the button selection of **NEXT** and **CHANGE**. Tap **CHANGE** to select the fuel unit required. Once you have chosen the fuel unit value, hold buttons 1 and 2 until you see "SET XXX". Then Tap the **NEXT** button until you see **END?** Tap **YES** to exit the **FACTORY** mode. Tap **NO** to return to the beginning of the **FACTORY** menu.

Selecting Lean of Peak as a default

Once in the **FACTORY** menu, tap the **NEXT** button until you see **LOP DFLT? N**. Tap **YES** to make Lean of Peak your default lean find method or **NO** to keep Rich of Peak your default setting.

Swapping the RPM and MAP gauge positions

Once in the **FACTORY** menu, tap the **NEXT** button until you see **SWAP DIALS? N**. Tap **YES** to swap gauge positions or **NO** to keep it the way it is, unless it already says **YES** in which case you tap **NO** to swap gauge positions.

Adjusting Airframe Hobbs and Tachometer times

Once in the **FACTORY** menu, tap the **NEXT** button until you see **END?** Hold both buttons 1 and 2 until you see **HOBBS TIMES**. You will then see **AIRFRAME HOBBS: XXXX.X**. Hold buttons 1 and 2 again until you see **ADJUST** and one of the digits flashing. Tap the **DIGIT** button to move to the next digit and the **PLUS** and **MINUS** buttons to select the desired number. Once done, hold both

buttons **1** and **2** to SET the change.
The next value you will see is
TACH TIME: XXXXX.X. Hold
both buttons **1** and **2** to begin the
change procedure as previously
explained for Airframe Hobbs.

QUICK REFERENCE

Refueled the Aircraft

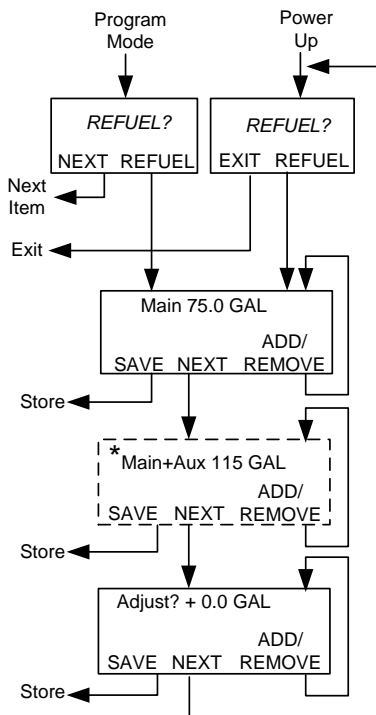

* If no aux tank is set up, then this step is skipped.

Reset Alarm

- **Temporary reset** (next 10 minutes): tap STEP.
- **Reset for remainder of flight:** hold STEP until the words Alarm Off appears.

Leaning Rich of Peak

1. Pre-lean & wait 20 seconds.
2. Tap LF & see ROP.
3. Lean until LEANEST flashes, then EGT 1485 FF 12.7 appear.
4. Tap LF to see degrees lean of peak: EGT- 23 FF 12.7
5. Enrich back to rich side of peak, then set desired degrees rich of peak: EGT- 41 FF 13.9
6. If desired, hold LF to see temp & FF when peak occurred: EGT 1534 FF 13.2
7. Tap EXIT to return to normal operation.

Leaning Lean of Peak

1. Pre-lean then wait 20 seconds.
2. Tap LF (if you see ROP, then hold STEP & LF until LOP appears).
3. Lean mixture noting that inverted columns appear.
4. Continue leaning until RICHEST flashes then EGT -73 FF 10.4 appear.
5. Adjust mixture to desired degrees lean of peak: EGT- 54 FF 10.9
6. If desired, hold LF to see the peak EGT of first cylinder to peak and the delta fuel flow (GAMI spread): EGT 1560 FF 1.0
7. Tap EXIT to return to normal operation.

NOTE: Values shown are examples and may vary for your aircraft